

the creative  
stitch



PRODUCTION



# GIFTING ESSENTIALS

2022



## GIFTS FOR THE PLANET

A gifts collection dedicated to serious sustainability and giving back to impactful organizations. Say no to greenwashing and tell the true story of sustainability with transparency built into this collection. We hope to inspire you with a gifts collection that is better for the planet and better for society.

**CHANGE.**  
SERIOUS SUSTAINABILITY

**IMPACT**





 **CHANGE IS IN OUR CHOICES** 



# ICONS

## LUXURY



reSound™ material



Bamboo



Eco Friendly



BPA free



Recycled PET



Water proof

## QUALITY



Bluetooth Enabled



Microphone



Audio



Genuine Leather



Wireless Charging



Dishwasher Safe



go Green  
Buy Earth Friendly Products

## CREATIVE



Camera Accessory



Double Wall



Leak-proof



Battery



Touch Screen



App Related



Light Up Logo

## VALUE



Tested for Antibacterial Effectiveness



Tested for Antimicrobial Effectiveness



Wheat Straw



Antimicrobial



Antibacterial



UV-C Sterilization

## HOW TO USE QR CODES ?

Step 1: Go to PLAY STORE (For Android users) & Download the QR code reader app, Apple users can scan the code directly from the camera app.



Step 2: Launch the downloaded QR code reader app & position your mobile device in such a way that the edges of the QR code fits the boundaries indicated on the screen.

Step 3: The code will be scanned by the app & a beep will be heard following which a link open approval will be prompted. Click OK & you will be directed to the webpage whose address is embed in the QR code.

# BRANDS

## AVAILABLE WITH US IN READY STOCK

A great brand inspires confidence and trust in consumers. Also, its a distinct sense of style and sophistication. Thus, brand-name products are an excellent medium for Advertising and Promotion. Through our exclusive brand-partners from around the globe, we bring you an exciting range of high-quality, on-trend Corporate/Business Gifts and Premiums that you can be proud to associate your brand with.

MOLESKINE®

 CROSS

XDDESIGN®

SANTHOME

Pitchfix®  
com

Hans Larsen™

 c-secure

ocean  
bottle

XD COLLECTION

 SWISS  
PEAK®

TUMI

Samsnite

XD XCLUSIVE®

 SKROSS®  
ADAPT TO THE WORLD

SANTHOME  
PROTECT

 SANTHOME  
*Golf • Legacy*

Giftology

 otto hutt

tekhnologia  
by @MEMORI

@MEMORI

vivo®

Villeroy & Boch Group

Tacx  
BIO BOTTLES MADE IN THE NETHERLANDS

UMA®  
PENS FROM GERMANY

GIORDANO

  
Tonino Lamborghini

eco-neutral

Swiss  
Highlander

  
DRY mcool  
BEST COMFORT

# BRANDING TECHNIQUES

The essence of promotional gifts and business giveaways is to make your mark on customers

A well branded product that carries your unique logo or brand message helps increase brand recognition, increases business value, generates new customers, improves employee pride & satisfaction and finally creates trust in the marketplace.

A great product needs impactful branding. Now convey your message in style !!



# CONTENTS

## SUSTAINABLE ECO-FRIENDLY COLLECTION

- The IMPACT Collection, The CHANGE- SERIOUSLY SUSTAINABLE Collection
- XDDESIGN Bobby Bags
- OCEAN BOTTLE- Small Bottle, Big Impact
- Drinkware and such Sets
- Face Mask from Certified Cotton
- Bags from Recycled Cotton, Normal Cotton, Non-woven, Jute, RPET
- Notebooks, Pens, Stationery Articles, Desk tops, Kids Stuff
- Wellness and Fitness
- Tech

07-58

## FIGHT-COVID RANGE: WE ARE RESPONSIBLE

- Tech
- Masks, Mask Accessories, Touchless Keyrings
- Notebooks and Pens
- Apparel incl. Polos, t-shirts and Caps
- Sets
- Backpacks
- UV-C Sterilization Technology

59-82

## TECHNOLOGY FRONTIERS

- UV-C Sterilization Technology
- True Wireless Stereo (TWS) Earbuds, Headphones, Fitness Trackers
- Wireless Chargers incl. Multifunctional, Magnetic
- Powerbanks, Speakers, USB Flash Drives, Portfolio Powerbanks
- Promotional Audio, Tablet / Charging Accessories, Gadgets, VR

77-126

## TRAVEL

- Travel Adapters, Luggage Scale, Neck Pillows, Passport / Documents Holder
- Cabin Trolleys, Overnighters, Garment Bags, Wash Bags

127-138

## BAGS

- Cabin Trolleys, Overnighters, Garment Bags, Wash Bags
- The IMPACT Collection, The CHANGE- SERIOUSLY SUSTAINABLE Collection
- Backpacks incl Samsonite, Cross, XDDESIGN, Santhome, Moleskine
- Messenger Bags and Laptop / Office Bags from Cross, Moleskine, Santhome
- Cooler Bags, Drawstring Bags, Duffel Bags, Shopping Bags
- Customised and Made in GCC Bags

135-188

## DRINKWARE AND FOODWARE

- The IMPACT Collection, The CHANGE- SERIOUSLY SUSTAINABLE Collection
- OCEAN BOTTLE- Small Bottle, Big Impact
- Water Bottles, Flasks, Mugs, Tumblers, Protein Shakers
- Sets with Drinkware, Tea and Coffee Ware
- Lunch Box

189-235

## FITNESS, WELLNESS AND SPORTS

- Workout Accessories, Activity Trackers, Enabling Accessories
- Accessories for Outdoors
- YOGA mats
- GOLF Collection & Requisites

235-260

## APPAREL

- Polo Shirts, T-shirts, Dress Shirts
- Hoodies, Sweater, Caps
- Customised Apparel

261-306

## WRITING

- Notebooks, Diaries, Sets of Notebooks and Pens
- Pens
- Portfolios, Organizers, Folders, Diaries

307-362

## DESK

- Desktops
- Tech and Lifestyle

363-373

- Stress Relievers, Lanyards, Coasters, Keyholders

374-378

## PERSONAL ACCESSORIES

- Card Holders
- Gift Sets
- TUMI & CROSS brands
- Moleskine, C-Secure & Pierre Cardin
- Genuine Leather
- Ladies Gifts

379-429

## YOUNG ONES & HAPPINESS

- Kids Stationery, Games
- Happiness Theme Giveaways

430-432

Automobile Accessories & Multi Tools

433-438

Miscellaneous Gifts

439-440

Bukhoor

441

Boxes & Packaging

442-444

Clearance Items

445

Glossary

446-448

Compliance Statements

449

Location Maps

450

# THE END OF GREENWASHING

Greenwashing refers to false sustainability claims - a growing problem for the modern conscious buyer

We believe true sustainability starts with **TRANSPARENCY & TRACEABILITY**

Our new **IMPACT and CHANGE** collections aim to end greenwashing and lead our industry in a new direction

**AWARE**®

 water.org®

With AWARE™, the use of genuine recycled fabric materials and water reduction impact claims are guaranteed, by using the AWARE disruptive physical tracer and blockchain technology.

With every purchase of IMPACT and CHANGE collection products, **a donation is made to Water.org**, a non-profit that provides access to safe water and sanitation. They have helped **over 36 million** people access safe water to date!



**IMPACT**

**CHANGE.**  
SERIOUS SUSTAINABILITY

*All items made with recycled plastic and recycled cotton, certified by the Global Recycled Standard.*

*CHANGE Collection is about design, serious sustainability and giving back.*

*All recycled content & water saving claims validated with AWARE™ tracer technology*

*All recycled fabrics are certified by the Global Recycled Standard.*

**Gifts that give water:** 2% of sale proceeds from this collection have been donated by Xindao, BV, The Netherlands to Water.org to save lives with safe water

**Gifts that give water:** 3% of sale proceeds from this collection is committed by brand owners to Water.org to save lives with safe water





Blue

Grey

White

Green

Aqua Green



Black

READY STOCK

## STAINLESS STEEL BOTTLE WITH BAMBOO LID

### QUALITY

- > Double-Walled water bottle
- > SS 304 Inside, SS 201 Outside
- > 560 ml Capacity
- > Vibrant Colors
- > High quality
- > 3% of sales proceeds of each product committed to Water.org
- > 24 hours cold, 8 hours hot

### GIFTS THAT GIVE BACK

💧 785 million people - 1 in 9 - lack access to safe water. We are supporting Water.org to change this.

💧 For each CHANGE bottle sold, **3% of sales is donated** by the brand owners to Water.org to save lives with safe water and sanitation.



BREDA

DWHL 337 - Black DWHL 338 - White DWHL 339 - Grey DWHL 340 - Blue DWHL 343 - Green DWHL 344 - Aqua Green

Hans Larsen™ Breda is part of Hans Larsen CHANGE. Collection. Proudly use this bottle knowing that you have made a Change in someone's life through our contribution to water.org.

Print Technique : ENG, UV, SC  
Product Size: ø7 x 24.5 cm

Preferred Print Location : Front & Top

Max Print Size : (Front) 120 x 25 mm (Top) ø 40 mm

Packing Details: 39.5 X 39.5 X 28.5 cms ; 25 pcs / carton ; gw / nw : 9.5 / 7.5 kg / carton



QUALITY



READY STOCK



## STAINLESS STEEL TUMBLER WITH METAL STRAW

- > 3% of sales proceeds of each product committed to Water.org
- > 15 hours cold, 5 hours hot
- > High-end Tumbler with flexible straw
- > Straw Cleaner in high quality stainless steel included
- > 540 ml Capacity
- > Double-Walled
- > SS 304 Inside, SS 201 Outside

### GIFTS THAT GIVE BACK

- 💧 785 million people - 1 in 9 - lack access to safe water. We are supporting Water.org to change this.
- 💧 For each CHANGE tumbler sold, **3% of sales is donated** by the brand owners to Water.org to save lives with safe water and sanitation.



BORCULO

DWHL 331 - Black DWHL 332 - White

Hans Larsen™ Borculo prevents drinks from spilling, the straw ensuring you drink comfortably on the move. A highly elegant Tumbler whose purchase triggers a contribution to water.org ensuring safe water to someone in need.

Print Technique : ENG, UV, SC  
Product Size: ø8 x 17 cm

Preferred Print Location : (Colored Front) (Steel Front) Max Print Size : (Colored Front) 100 x 25 mm (Steel Front) 30 x 25 mm  
Packing Details : 57 X 34 X 25 cms ; 30 pcs / carton ; gw / nw : 10.9 / 8.6 kg / carton



READY STOCK

## STAINLESS STEEL MUG WITH BAMBOO LID

QUALITY

- > 3% of sales proceeds of each product committed to Water.org
- > 15 hours cold, 5 hours hot
- > A Designer Mug that supports Sustainable living
- > Double-Walled
- > SS 304 Inside, SS 201 Outside

### GIFTS THAT GIVE BACK

- 💧 785 million people - 1 in 9 - lack access to safe water. We are supporting Water.org to change this.
- 💧 For each CHANGE mug sold, **3% of sales is donated** by the brand owners to Water.org to save lives with safe water and sanitation.



LAREN

DWHL 334 - White DWHL 333 - Black DWHL 336 - Green DWHL 335 - Blue DWHL 341 - Grey DWHL 342 - Aqua Green

Hans Larsen™ Inspired by Scandinavia, Laren is created for the discerning connoisseur who loves the best. 3% of the sale proceeds go to water.org to change someone's life.

Print Technique : ENG, UV, SC  
Product Size: ø8.5 x 11 cm

Preferred Print Location : Front of Mug & Lid of Mug Max Print Size : (Front of Mug) 50 x 25 mm (Lid of Mug) ø 80 mm  
Packing Details : 55.5 X 28.5 X 27cms ; 36 pcs / carton ; gw / nw : 10.6 / 8.6 kg / carton



- > Stainless Steel Water Bottle
- > SS 304 Inside, SS 201 Outside
- > Double Walled Vacuum
- > 24 Hours Cold & 8 Hours Hot
- > Leak Proof
- > Screw-On Cap; BPA Free
- > 500 ml Capacity



READY STOCK



### GIFTS THAT GIVE BACK

785 million people - 1 in 9 - lack access to safe water. We are supporting Water.org to change this.

For each CHANGE bottle sold, **3% of sales is donated** by the brand owners to Water.org to save lives with safe water and sanitation.



HUNFELD  
DWHL 280 - Black DWHL 281 - White

Hans Larsen™ CHANGE Double Walled Stainless Steel Vacuum Water Bottle (500ml). This bottle makes an impact by supporting Water.org to provide safe water to people in need with every purchase. Packed in an elegant recycled gift box.

Print Technique : UV, SC, ENG Preferred Print Location : Front Max Print Size : 110 X 20 mm  
Product size : ø 6.8 x 26 cm Packing Details : 45 x 30.5 x 28.4 cm ; 24 pcs /carton ; gw/nw: 6.5/8 kg/ carton



**IMPACT**  
100% Fully Recycled

**READY STOCK**

Navy Blue

White

Black

**SAY NO TO GREENWASHING**

*Tell the true story of sustainability with genuine recycled rPET and cotton with validated claims.*

Certified by Global Recycled Standard

**GIFTS THAT GIVE BACK**

- 785 million people - 1 in 9 - lack access to safe water. We are supporting Water.org to change this.
- For each IMPACT cap sold, 2% of sales is donated by the Xindao B.V. (Netherlands) to Water.org to save lives with safe water and sanitation.



**READY STOCK**

- > 2% of sales proceeds of each product committed to Water.org
- > Made of 100% recycled materials

- > Made with AWARE™ tracer
- > This cap saved 387 litres of water

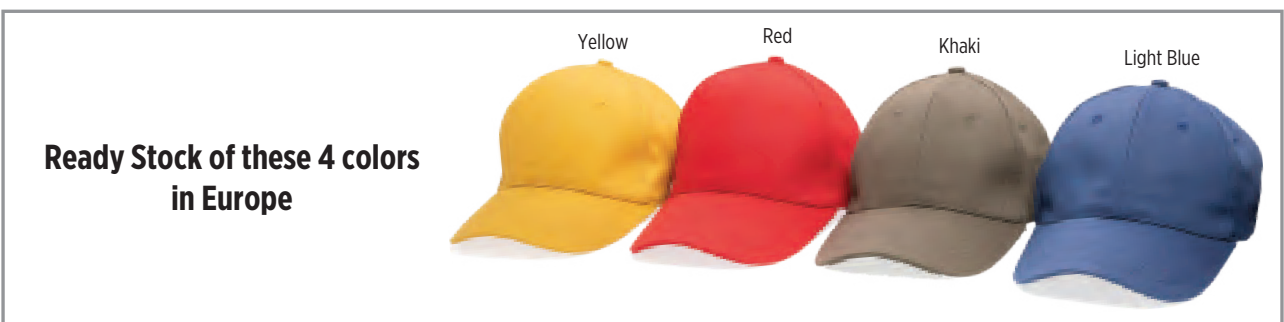

280 gr Recycled Cotton Cap with Aware Tracker - XD Impact Collection

HWAW 451 - Black HWAW 452 - White HWAW 453 - Navy Blue

**XD COLLECTION** No greenwashing, but telling a true story about sustainability! This Impact collection is made with AWARE™ tracer. With AWARE™, the use of genuine recycled fabric materials and water reduction impact claims are guaranteed by using the AWARE disruptive physical tracer and blockchain technology. Save water and use genuine recycled fabrics. With the focus on water 2% of proceeds of sold Impact product has been donated to Water.org. This cap has saved 387 litres of water. A simple and comfortable cap suited for anyone. This 6 panel cap has a curved visor, embroidered eyelets for ventilation and metal buckle. Cotton twill made of 100% recycled materials and AWARE™ tracer. The material weight is 280 g/m2. Size 58cm.

Print Technique : HT, SC, EMBROIDERY  
Product Size: 58 cm

Preferred Print Location : Front  
Packing Details : 36.5 X 45.5 X 69.5 cms ; 200 pcs / carton ; gw / nw : 17 kg / carton

Max Print Size : 45 x 35 mm

# Recycled Polo

## Our Transparent Process

**COLLECTION**  
of plastic bottles,  
removing labels & foreign materials,  
making it process - ready



**COLLECTION**  
of cotton fabric waste,  
also called post-industrial  
cotton waste, making it  
process-ready



**SHREDDING**  
Used water bottles into  
fiber, certified by the  
Global Recycled Standard



**SHREDDING**  
post-industrial cotton waste  
into fiber, certified by the  
Global Recycled Standard



**YARNS**  
produced by spinning the fiber



**YARNS**  
produced by spinning the  
fiber



**FABRIC**  
produced by using cotton &  
plastic yarns together



**APPAREL**  
produced from the Recycled fabric,  
certified by the Global Recycled Standard



**VERIFICATION DOCUMENT**  
available, as the above process is  
entirely transparent

**GREENWASHING DISCOURAGED**  
by using above verifiable process,  
ensuring positive impact on  
environment



**PLEGGED DONATION**  
of 3% of sales proceeds to  
water.org ensures safe water  
& sanitation to the needy

**Plastic Bottles**  
recycled, positive impact



**RECYCLED COTTON**  
ensures fresh cotton is  
not used, positive impact



**WATER SAVINGS**  
as fresh cotton fabric  
production consumes  
huge quantities of water



SANTHOME

**PRO EARTH**  
SHIRT IS MADE FROM  
17 PLASTIC BOTTLES



THIS SHIRT HAS SAVED  
1,260L OF WATER

SANTHOME

**PRO EARTH**  
FULLY RECYCLED POLO

MADE FROM  
60% RECYCLED COTTON  
AND 40% RECYCLED PET





The PRO EARTH Polos from Santhome use

LESS WATER • LESS CHEMICALS • LESS EMISSION • LESS ENERGY • LESS WASTE • REDUCE CARBON FOOTPRINT



Navy Blue



White



Black

-1,260L

17

READY STOCK

> 3% of sales proceeds of this Polo committed to Water.org by the brand owners

Item : PRO Earth Polo

Content : 40% Recycled PET, 60 % Recycled Cotton

Measurement : Gulf Sizes

Sizes Available : S- XXXL

Care Instructions:

Print Technique :

- 1 Screen Printing
- 2 Heat Transfer
- 3 Embroidery

Preferred Print Location : Max Print Size:  
Left Chest Area / Sleeve 80 x 50 mm

PRO EARTH POLO

**CHANGE.**  
SERIOUS SUSTAINABILITY

THIS SHIRT IS MADE FROM 17 PLASTIC BOTTLES

THIS SHIRT HAS SAVED 1,260L OF WATER

SANTHOME

**PRO EARTH**  
FULLY RECYCLED POLO

MADE FROM 60% RECYCLED COTTON AND 40% RECYCLED PET

**THE GIFT OF WATER**

For each product sold, the brand owner will donate 3% of sales to support Water.org to change lives with safe water and sanitation

a US-based 501(c)(3) global non-profit organization

**785M**

785 million people - 1 in 9 - lack access to safe water

We are supporting Water.org to change this



- > High end - Sustainable Travel accessory
- > Made from GRS-Certified Recycled Fabric
- > This Bag saved 10 litres of water
- > This Bag is made by recycling 4 plastic bottles

HPSN 551 - TRIKOMO

SANTHOME CHANGE Wash Bag / Toiletries Pouch - made with high-end durable 1680D recycled rPET (certified by GRS) and stylish leather components. Get your essentials organized while supporting Water.org to provide safe water to people in need with each purchase. Each bag saves 10L of water and reuses 4 plastic bottles

Print Technique : SC Preferred Print Location : Front Max Print Size : 110 x 50 mm

Product size : 23 X 14 X 10.5 cm

### SAY NO TO GREENWASHING

*Tell the true story of sustainability with genuine recycled rPET*

Certified by



### GIFTS THAT GIVE BACK

785 million people - 1 in 9 - lack access to safe water. We are supporting Water.org to change this.

For each CHANGE bag sold, 3% of sales is donated by brand owners to Water.org to save lives with safe water and sanitation.



READY STOCK



- > High end - Sustainable Travel accessory
- > Made from GRS-Certified Recycled Fabric
- > This Bag saved 9 litres of water
- > This Bag is made by recycling 4 plastic bottles



HPSN 552 - POMOS

SANTHOME CHANGE Technology Accessories Kit - made with high-end durable 1680D recycled rPET (certified by GRS) and stylish leather components. Organizes all tech accessories (like cables, chargers, power banks, adapters, etc.). Great for office or travel. Each bag saves 9L of water and reuses 4 plastic bottles, while supporting Water.org to provide safe water to people in need with each purchase.

Print Technique : SC

Preferred Print Location : Front

Max Print Size : 120 x 100 mm

Product size : 27 X 16 X 7 cm





- > Made from Recycled PET fabric certified by Global Recycled Standards
- > 3% of sales proceeds of each product is committed to Water.org
- > High-end Sustainable
- > This bag saved 43 liters of water
- > This Bag is made by recycling 17 plastic bottles



**GO directly to office from gym -  
Go directly to gym from office**

**AN EXECUTIVE  
Duffel Bag**

**SAY NO TO GREENWASHING**

*Tell the true story of sustainability with genuine recycled rPET*

**Certified by**



**GIFTS THAT GIVE BACK**

- 💧 785 million people - 1 in 9 - lack access to safe water. We are supporting Water.org to change this.
- 💧 For each CHANGE bag sold, **3% of sales is donated** by brand owners to Water.org to save lives with safe water and sanitation.



**READY STOCK**



**DBSN 661 - PEGEIA**

SANTHOME CHANGE Duffel / Weekender / Gym Bag made from high-end durable 1680D recycled rPET (certified by GRS) and stylish leather components. Includes special shoe compartment. Each bag saves 43L of water and reuses 17 plastic bottles, while supporting Water.org to provide safe water to people in need with each purchase.

Print Technique : SC, HT

Preferred Print Location : Pocket

Max Print Size : 100 X 200 mm

Product size : 54 x 26 x 25 cm



**IMPACT**

AWARE™ RPET WEEKEND DUFFLE BAG

XD COLLECTION

**SAY NO TO GREENWASHING**

*Tell the true story of sustainability with genuine recycled rPET and cotton with validated claims.*

Certified by



**GIFTS THAT GIVE BACK**

785 million people - 1 in 9 - lack access to safe water. We are supporting Water.org to change this.

For each IMPACT bag sold, 2% of sales is donated by the Xindao B.V. (Netherlands) to Water.org to save lives with safe water and sanitation.



READY STOCK

- > 2% of proceeds of each product committed to Water.org
- > This bag is made of 45 recycled bottles
- > Made with AWARE™ tracer
- > This bag saved 27 liters of water



DBAW 457 - DUFFLE BAG

**XDDESIGN** No greenwashing, but telling a true story about sustainability! This Impact collection is made with AWARE™ tracer. With AWARE™, the use of genuine recycled fabric materials and water reduction impact claims are guaranteed, by using the AWARE disruptive physical tracer and blockchain technology. Save water and use genuine recycled fabrics. If you choose this item you save 27 litres of water and 45 plastic bottles have been reused. With the focus on water, 2% of proceeds of each Impact product sold is donated to Water.org. The AWARE™ weekend duffle impresses with its modern and simple look. Its clean design makes the duffle ideal for travel. The roomy main compartment offers plenty of space for your essentials. Two mesh pockets make your smaller items easy to find. The front zipper pockets have 2 sleeve pockets and 2 pen loops. Interior and exterior 100% recycled polyester with AWARE™ tracer. PVC free.

Print Technique : SC

Preferred Print Location : Front

Max Print Size : 250 x 35 mm

Product Size: 32 x 22 x 55 cm

Packing Details : 43 X 36 X 59 cms ; 15 pcs / carton ; gw / nw : 11.5 kg / carton



**SAY NO TO GREENWASHING**

*Tell the true story of sustainability with genuine recycled rPET and cotton with validated claims.*

Certified by Global Recycled Standard

**GIFTS THAT GIVE BACK**

- 785 million people - 1 in 9 - lack access to safe water. We are supporting Water.org to change this.
- For each IMPACT bag sold, **2% of sales is donated** by the Xindao B.V. (Netherlands) to Water.org to save lives with safe water and sanitation.



READY STOCK

- > 2% of proceeds of each product donated to Water.org
- > This bag is made of 26 recycled bottles
- > Made with AWARE™ tracer
- > This bag saved 15 liters of water

MBAW 461 - Black MBAW 462 - Navy Blue

**XD COLLECTION** No greenwashing, but telling a true story about sustainability! This Impact collection is made with AWARE™ tracer. With AWARE™, the use of genuine recycled fabric materials and water reduction impact claims are guaranteed, by using the AWARE disruptive physical tracer and blockchain technology. Save water and use genuine recycled fabrics. If you choose this item you save 15 litres of water and 26 plastic bottles have been reused. With the focus on water, 2% of proceeds of each Impact product sold is donated to Water.org. Casually professional and organised, the Impact 15.6" laptop bag is made for the modern professional with an eye for value and the environment. It features a classic design with front accent stitching, multiple storage pockets, two top handles, and an adjustable, detachable shoulder strap. The outer fabric and inner lining consist of 100% recycled polyester with AWARE™ tracer. PVC free.

Print Technique : SC Preferred Print Location : Front Max Print Size : 180 x 30 mm  
Product Size : 28 x 6 x 39.5 cm Packing Details : 49.5 X 38.5 X 48.5 cms ; 12 pcs / carton ; gw / nw : 5.5 kg / carton

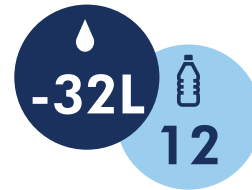

READY STOCK

- > Made from Recycled PET fabric certified by Global Recycled Standards
- > 3% of sales proceeds of each product is committed to Water.org
- > This bag saved 32 liters of water
- > Back trolley strap to attach backpack to trolley bag
- > This Bag is made by recycling 12 plastic bottles



**SAY NO TO GREENWASHING**

*Tell the true story of sustainability with genuine recycled rPET*

Certified by



**GIFTS THAT GIVE BACK**

- 💧 785 million people - 1 in 9 - lack access to safe water. We are supporting Water.org to change this.
- 💧 For each CHANGE bag sold, 3% of sales is donated by brand owners to Water.org to save lives with safe water and sanitation.



MBSN 972 - OIKOS

SANTHOME CHANGE Laptop Office Bag made from high-end durable 1680D recycled rPET (certified by GRS) and stylish leather components. Convenience pockets in the front for quick access of mobile phones, documents, etc. Each bag saves 32L of water, reuses 12 plastic bottles and makes an impact by supporting Water.org to provide safe water to people in need with each purchase.

Print Technique : SC

Preferred Print Location : Front

Max Print Size : 170 X 200 mm

Product size : 38 x 28 x 7 cm

Packing Details : 69 x 60 x 49 cm ; 6 pcs /carton ; gw/nw: 10.9 kg/ carton



- > Made from Recycled PET fabric certified by Global Recycled Standards
- > 3% of sales proceeds of each product is committed to Water.org
- > This bag saved 35 liters of water
- > This Bag is made by recycling 14 plastic bottles
- > Expandable zipper adds additional storage
- > Back trolley strap to attach backpack to trolley bag

-35L 14



Takes in a lot of stuff



Trolley Strap for attaching to trolley bag

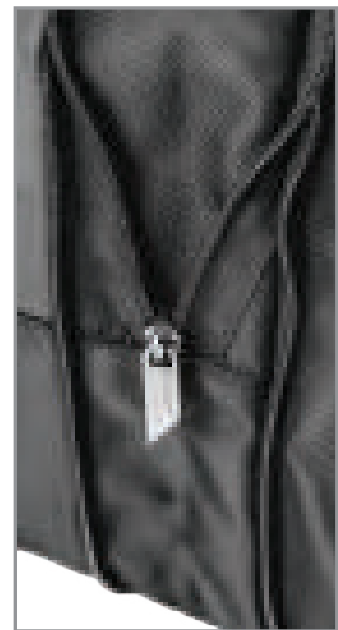

Expandable Zipper

**SAY NO TO GREENWASHING**

*Tell the true story of sustainability with genuine recycled rPET*

Certified by Global Recycled Standard

**GIFTS THAT GIVE BACK**

- 💧 785 million people - 1 in 9 - lack access to safe water. We are supporting Water.org to change this.
- 💧 For each CHANGE bag sold, **3% of sales is donated** by the brand owner to Water.org to save lives with safe water and sanitation.



**READY STOCK**

**BPSN 796 - MARGO**

SANTHOME CHANGE Laptop Backpack made from high-end durable 1680 recycled rPET (certified by GRS) and stylish leather components. Elegant executive design. Extra zipper provided expandable storage space. Each bag saves 35L of water and reuses 14 plastic bottles, while supporting Water.org to provide safe water to people in need with each purchase.

Print Technique : SC

Product size : 44 x 30 x 13 cm (Expanded) 44 x 30 x 17 cm

Preferred Print Location : Front Top & Bottom

Max Print Size : 100 X 130 mm

Packing Details : 69 x 60 x 49 cm ; 6 pcs /carton ; gw/nw: 10.9 kg/ carton





- > 2% of proceeds of each product donated to Water.org
- > This bag is made of 33 recycled bottles
- > Made with AWARE™ tracer
- > This bag saved 19 liters of water

READY STOCK

**SAY NO TO GREENWASHING**

*Tell the true story of sustainability with genuine recycled rPET and cotton with validated claims.*

Certified by

**GIFTS THAT GIVE BACK**

- 785 million people - 1 in 9 - lack access to safe water. We are supporting Water.org to change this.
- For each IMPACT bag sold, 2% of sales is donated by the Xindao B.V. (Netherlands) to Water.org to save lives with safe water and sanitation.

BGAW 458 - Black    BGAW 459 - Anthracite    BGAW 460 - Navy Blue

**XD COLLECTION** No greenwashing, but telling a true story about sustainability! This Impact collection is made with AWARE™ tracer. With AWARE™, the use of genuine recycled fabric materials and water reduction impact claims are guaranteed, by using the AWARE disruptive physical tracer and blockchain technology. Save water and use genuine recycled fabrics. If you choose this item you save 19 litres of water and 33 plastic bottles have been reused. With the focus on water, 2% of proceeds of each Impact product sold has been donated to Water.org. The streamlined AWARE™ 15.6" laptop backpack includes a laptop sleeve in the main compartment and an inside sleeve pocket with 2 pen loops. A separate front zipper pocket can hold your small daily essentials. Interior and exterior 100% recycled polyester with AWARE™ tracer . PVC free.

Print Technique : SC                      Preferred Print Location : Front                      Max Print Size: 180 X 40 mm  
 Product Size : 44.5 X 12 X 30.5 cm                      Packing Details : 49.5 X 38.5 X 48.5 cm ; 12 pcs / carton ; gw / nw : 5.5 kg / carton

# REDUCING THE USE OF WATER

BY USING TRACEABLE AND CERTIFIED RECYCLED MATERIALS WE SAVE HUGE AMOUNTS OF WATER

## EACH XD DESIGN SUSTAINABLE BACKPACK:

### REUSE

AN AVERAGE OF

# 31

### WATER BOTTLES



### SAVED

AN AVERAGE OF

# 18

### LITRES OF WATER

Bobby + Recycled PET  
= **BOBBY HERO**  
Anti - Theft Backpack  
(The ORIGINAL just got better)







Red



Black



Green



Grey



Navy Blue

Made from (rPET)  
Recycled PET Bottles

Scan Below QR  
code to watch  
product video



Light Blue

- Each bag is made of 27 plastic bottles
- Each bag saves 16 liters of water
- Made with AWARE™ tracer

READY STOCK



BOBBY HERO

BGXD 625 - Black    BGXD 626 - Grey    BGXD 627 - Navy Blue    BGXD 628 - Red    BGXD 629 - Green    BGXD 630 - Light Blue

XDDESIGN® The Bobby Hero line is our new generation of anti-theft backpacks. This new model will help you to move safely, carefree and organised. Key features such as cut-proof protection, hidden zipper closures & pockets will keep your belongings safe during your commutes. Bobby is also the most convenient backpack with features such as an integrated USB charging port, water-repellent fabric, illuminating safety strips and a luggage strap. On the inside there are padded compartments for a 15.6" laptop, tablet up to 12.9" and all your other belongings. Made from R-pet materials and AWARE™ tracer. With AWARE™, the use of genuine recycled fabric materials and water reduction impact claims are guaranteed, by using the AWARE disruptive physical tracer and blockchain technology. Each Bobby Hero regular saves 16 litres of water and reuses 27 plastic bottles. Registered design®

Print Technique : SC

Preferred Print Location : Front

Max Print Size : 150 X 150 mm

Product size : 45 x 16 x 29 cm

Packing Details : 69 x 60 x 49 cm ; 6 pcs /carton ; gw/nw: 10.9 kg/ carton



# THE BOBBY SLING BAG



Made from genuine recycled fabric  
All IMPACT claims verified using AWARE disruptive physical tracer & Blockchain technology

**IMPACT**

For each product sold we have donated 2% of proceeds to support Water.org to change lives with safe water.

THIS BAG IS MADE OF 20 RECYCLED WATER BOTTLES



THIS BAG SAVED 12L WATER

785 million people — 1 in 9 — lack access to safe water

We are supporting Water.org to change this.



Xindao B.V.  
The Netherlands

For more info visit: [www.theimpactcollection.org](http://www.theimpactcollection.org)

READY STOCK





-  
12L

Made from (rPET)  
Recycled PET Bottles



READY STOCK



BGXD 691 - BOBBY SLING

**XDDESIGN®** Safe, comfortable and smart, the Bobby Sling was designed for the city travellers. Feel protected with the famous Bobby anti-theft features like hidden zippers, no front access, RFID protected pocket and cut resistant material, also a 3 point safe buckle will make sure that your daily essentials are always along your body. Additional features like water-resistant material and integrated USB charging port makes this crossbody backpack the most convenient option for your everyday journey. Made from R-pet materials and AWARE™ tracer. With AWARE™, the use of genuine recycled fabric materials and water reduction impact claims are guaranteed, by using the AWARE disruptive physical tracer and blockchain technology. Each Bobby Sling saves 12 litres of water and reuses 20 plastic bottles. Registered design®

Print Technique: SC Preferred Print Location : Front Max Print Size : 120 X 120 mm  
 Product size : 32.5 x 9 x 21 cm Packing Details : 38 x 51 x 53.5 cm ; 8 pcs /carton ; gw/nw: 7.5 kg/ carton



READY STOCK

**IMPACT**

For each product sold we have donated 2% of proceeds to support Water.org to change lives with safe water.

**THIS PORTFOLIO IS MADE OF 7 RECYCLED WATER BOTTLES**



**THIS PORTFOLIO NOTEBOOK SAVED 4L WATER**

785 million people — 1 in 9 — lack access to safe water  
We are supporting Water.org to change this.



Xindao B.V.  
The Netherlands

For more info visit:  
[www.theimpactcollection.org](http://www.theimpactcollection.org)



Features -

Cadmium content

Confirms to the Cadmium Directive 91 | 338 | EC

Lead content

U.S. Lead content compliance

SCCP

Free from single & multichain chlorinated paraffins

NBAW 454 - Black NBAW 455 - Anthracite NBAW 456 - Navy Blue

XD COLLECTION No greenwashing, but telling a true story about sustainability! This Impact collection is made with AWARE™ tracer. With AWARE™, the use of genuine recycled fabric materials and water reduction impact claims are guaranteed, by using the AWARE disruptive physical tracer and blockchain technology. Save water and use genuine recycled fabrics. If you choose this item you save 4 litres of water and 7 plastic bottles have been reused. With the focus on water, 2% of proceeds of each Impact product sold is donated to Water.org. Keep all your work essentials organised with the A5 AWARE™ RPET portfolio. Inside the portfolio you can find a matching notebook. The notebook contains 64 sheets/128 sheets cream coloured lined 80gm/s FSC recycled paper. Inside you will find 1 big sleeve pocket, a phone pocket, 2 card slots and pen loop. Interior and exterior 100% recycled polyester with AWARE™ tracer. PVC free.

Print Technique : SC Preferred Print Location : Front Max Print Size : 100 x 80 mm Product Size : 2.1 x 17.2 x 22.2 cm Packing Details : 26.5 X 37.5 X 39.5 cms ; 20 pcs / carton ; gw / nw : 11 kg / carton

**1 Ocean bottle = 1000 Ocean - Bound Plastic Bottles Collected**

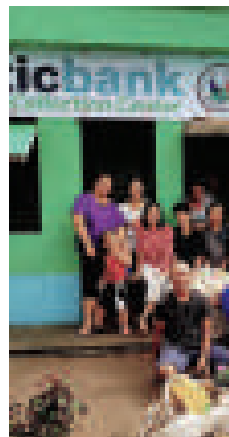

*"Ocean bottle is the first tangible ocean impact we have"*

**London Evening Standard**

*"If Apple designed a drinks container for life, this would be it."*

**THE TIMES**

*"Fighting plastic pollution at a grassroots level"*

**Forbes**



# SERIOUSLY SUSTAINABLE DRINKWARE

When you buy an Ocean Bottle, you fund the collection of 1000 ocean-bound plastic bottles in weight.

Locals in coastal communities turn these bottles into a sustainable livelihood, using our innovative exchange platform.

We're making a real impact. Be a part of it.

## CASE STUDIES



ocean bottle

### WHY OCEAN BOTTLE

- Internal Merchandising Webshop
- Split orders across Multiple offices to get quantity discount
- Used for ESG Focused stakeholder gifting



#### GIFTING



504

OB'S PURCHASED



504,000

PLASTIC BOTTLES COLLECTED



5,746

KGS OF OCEAN BOUND PLASTIC



ocean bottle

### WHY OCEAN BOTTLE

- Mercedes HQ purchased bottles for prospective client gifts at Corporate Event focused on;
  - Golf Events
  - Motorsport Events
- The events Include:
- Ladies Business Cup
  - AWGC Tour
  - Mercedes Trophy Golf
  - Mercedes-AMG Track days



#### GIFTING



4,100

OB'S PURCHASED



4,100,000

PLASTIC BOTTLES COLLECTED



46,740

KGS OF OCEAN BOUND PLASTIC



ocean bottle

### WHY OCEAN BOTTLE

- Engaged 2000 employees in the Nordics with a corporate social ocean saving initiative
- Plastic-free mission on-site, they gave employees a headstart in using a reusable bottle instead of buying a plastic water bottle



#### COMPANY GIFTING



2,000

OB'S PURCHASED



2,000,000

PLASTIC BOTTLES COLLECTED



22,800

KGS OF OCEAN BOUND PLASTIC



# OCEAN BOTTLE AWARDS



reddot winner 2020



## IMPACT

One Ocean Bottle funds the collection of **11.4kg** plastic, equivalent to **1000** plastic bottles.



SERIOUSLY SUSTAINABLE DRINKWARE

# Corporate's Certificate (example)

**CERTIFICATE OF SOCIAL PLASTIC COLLECTION**

PROUDLY AWARDED TO  
**EXAMPLE COMPANY**



IMPACT CERTIFICATE

FOR PREVENTING  
**46,609 KGS**

FROM ENTERING OUR OCEAN.

POWERED BY IBM BLOCKCHAIN+  

ISO 17033 Ethical Claims Verified  
26000 Social Responsibility Verified  
SEDEX Compliant

  
Will Pearson  
CEO & Co-Founder

  
Nick Doman  
COO & Co-Founder

January 2021  
www.oceanbottle.co  
@oceanbottle

READY STOCK

## INTERACTIVE PACKAGING THAT TELLS THE STORY OF THE IMPACT

**Small Bottle BIG IMPACT**

This is the bottle that stops 1000 plastic bottles from entering the ocean

Discover more

**HOW IT WORKS**

**YOU**  
Buy one Ocean Bottle and help stop the 22 million kgs of plastic entering our ocean each day

**1 FOR 1000**  
Each Ocean Bottle funds the collection of 11.4kg of ocean bound plastic, equivalent to 1000 500ml plastic bottles

**PLASTIC COLLECTORS**  
Plastic is collected by locals living in coastal communities around the world and enabled by our partners

**FINANCIAL EMPOWERMENT**  
Collectors can exchange plastic for money or digital tokens to swap for healthcare, tuition, tech goods or micro-finance

**CLOSING THE LOOP**  
Ocean bound plastic is recycled into new products, helping turn the tap off ocean plastic

- NFC Smart chip enabled for more impact
- Double opening for easy clean and use
- Easy carry loop
- Anti-leak seal
- Hot & cold stainless steel vacuum insulation
- Dishwasher safe up to 60°

BranchHid of Oslo  
Designed by K&N Norway  
Responsibly made in the high  
Midre from 50% tree & recyclable plastic,  
silicone rubber & stainless steel

Great Product Award  
Ocean Bottle

oceanbottle.co  
@oceanbottle

5 060702 410007





Sun



Sky



Forest



Ocean



Rock



Black



- > Reusable bottle that funds the collection of 1000 plastic bottles in weight
- > Dishwasher safe
- > 180° twist anti-leak lid with dual opening for drinking and easy cleaning
- > Vacuum stainless steel insulation keeping hot things hot and cold things cold
- > Ice, coffee, tea, juice, smoothies, still and sparkling water — it's all good

READY STOCK

OCEAN BOTTLE

DWOB 291 - Black DWOB 292 - Ocean DWOB 293 - Sun DWOB 294 - Sky DWOB 295 - Forest DWOB 296 - Rock

Our original award-winning 500ml Ocean Bottle keeps cold drinks cold, and hot drinks hot. Made from double wall vacuum-insulated stainless steel and recycled content. The anti-leak dual opening lid makes filling and cleaning a breeze. Plus, unlike most reusable bottles, Ocean Bottle is 100% dishwasher safe.

Available in six colours: Ocean Blue, Rock Grey, Sun Orange, Forest Green, Obsidian Black and Sky Blue.

Print Technique : SC, UV, ENG

Preferred Print Location : Front

Max Print Size : 120 X 25 mm

Product Size : 22 X ø 6.8 cm

Packing Details : 49 X 34 X 27 cm ; 24 pcs / carton ; gw / nw : 10 kg / carton



Useful eco-conscious gift set with sustainable packaging:

**Notebook** - Kraft cover with FSC-certified paper inside

**Mug** - Wheatstraw material with silicone sleeve

**Pen** - Made with wheatstraw material

VALUE

READY STOCK



Wheatstraw Mug w/ silicone



Notebook with FSC paper



Wheatstraw Pen

- > All products plus packaging from sustainable materials
- > Silicone sleeve helps hold mug with hot liquid
- > 80 pgs Notebook - 14 x 9 cm, 70 gsm
- > Give VALUE, Save Ecology when you give out this set
- > 380 ml Mug capacity



GSEN 681 - KORGAN

(Notebook) Print Technique : SC, UV

(Pen) Print Technique : SC, UV

(Mug) Print Technique : SC

Box Size: 14.5 x 10.3 x 9.7 cm; Each set of 3 in box weighs 176 gms

Preferred Print Location : Front

Preferred Print Location : Clip

Preferred Print Location : Front

Max Print Size : 70 x 130 mm

Max Print Size : 7 x 35 mm

Max Print Size : 30 x 50 mm



READY STOCK



Bamboo & Packaging-  
sustainable

Set of Eco Lunch Box & Vacuum Bottle  
GSHL 180 - CHAVES

Hans Larsen® (BOTTLE) Double wall stainless steel insulating vacuum flask with bamboo lid and carry handle. Capacity: 500 ml. Leak Proof Material- SS 304 Inside SS 201 Outside.  
(LUNCH BOX) Stainless Steel lunchbox with bamboo lid and 2 cutlery utensils with attachable polyester band. Capacity 700ml. Bamboo is a natural product, there may be slight variations in colour and size per item. Material- SS 304 Food Grade

(BOTTLE) Print Technique : SC, UV, ENG Preferred Print Location : Bottle Front & Top  
(LUNCH BOX) Print Technique : SC, ENG Preferred Print Location : Lunch Box Top & Side  
Box Size : 25.5 x 25.5 x 7.5 cm; Box with both items weighs 715 gms

Max Print Size : (Front) 30 x 40 mm (Top) ø 45 mm  
Max Print Size : (Top) 90 x 30 mm (Side) 30 x 100 mm



# BIO BOTTLES MADE IN THE NETHERLANDS

# Tacx

BIO BOTTLES MADE IN THE NETHERLANDS

**Tacx** Are you looking for a bottle fully made of biodegradable materials? Then the Bio-Bottle of Tacx is a great choice. It stands out because the plastic of the bottle is biodegradable. Adding a small amount of bio-material changes the molecular structure so the material finally breaks up in biogas and biomass. This feeds the soil and it's completely absorbed by nature. The process of disintegration starts when the bottle ends up at a microbiological environment (compost heap, waste disposal).



**WB 003**  
Transparent / Aqua Lid  
750CC



**WB 003**  
Silver - 750CC

## Made in THE NETHERLANDS

- Bio Degradable
- 100% Recyclable
- Safe for Food Use
- Screw-On Cap With A Leak Proof Spout
- Secure Grip On Triangular Cap For Easy - Opening And Closing Of Bottle
- Certified Bio-Degradable Water Bottles.
- FDA Approved For Contact With Food.
- OSHA Approved As Non-Hazardous.
- Indefinite Shelf Life.

READY STOCK



**WB 003**  
Transparent / Red Lid 750CC



**WB 003**  
Transparent / Purple Lid 750CC



**WB 003**  
Transparent / Blue Lid 750CC



**WB 003**  
Transparent / Orange Lid 750CC

## Stocks Available



**WB 002**  
Full Red  
500CC



**WB 002**  
Full White  
500CC



**WB 002**  
White/  
Blue Lid  
500CC

Print Technique : UV, SC Preferred Print Location : Center  
Max Print Size : (Flat) 33 x 50 mm, 230 x 50 mm ( Round )  
Product Size 500CC : ø7.7 x 19.6 cm  
Packing Details : 38 x 38 x 39 cm ; 50 pcs /carton ; gw/nw: 4.40 kg / carton



**WB 003**  
Transparent / Pink Lid 750CC



**WB 003**  
Transparent / Grey Lid 750CC



**WB 003**  
Transparent / Royal Blue Lid 750CC

Print Technique : UV, SC  
Product Size 750CC: ø7.7 x 25 cm

Preferred Print Location : Center Max Print Size : (Flat) 33 x 100 mm, 230 x 100 mm ( Round )  
Packing Details : 39 x 39 x 52 cm ; 50 pcs /carton ; gw/nw: 5.5 kg / carton



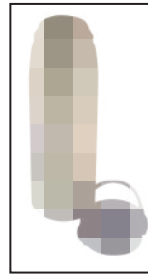
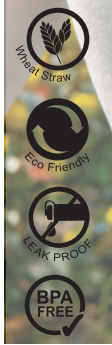

- > Glass Inside
- > ECO Wheat Straw Exterior
- > Phone Stand
- > 380 ml Bottle with carry handle



Mobile Stand

DWGL 361 - RABI

**eco-neutral** Eco Friendly water bottle with glass interior and wheat straw exterior. With convenient handle for easy carrying and a phone stand at the base. Capacity 380ml. BPA free. Packed in a gift box.

Print Technique : UV, SC, ENG  
Product Size : 21 x ø6.3cm

Preferred Print Location : Front Max Print Size : (Flat)30 X 100 mm; (Round) 100 X 190 mm  
Packing Details : 56 x 35.5 x 23.5 cm; 40 pcs /carton; gw/nw: 13/12 kg / carton

READY STOCK



Made from natural fast growing bamboo and 100% recyclable borosilicate glass, this reusable bottle is designed to support the environment.



- > Borosilicate Glass Body & Eco Bamboo Top Cap
- > Silicon Sleeve For Protection
- > Eco-Friendly !!



Hans Larsen™



DWHL 502 - MEGARA

**Hans Larsen™** Megara is made from glass that is 100% recyclable and that doesn't infuse harmful chemicals or unwanted flavours into your water like plastic or metal and eco-friendly bamboo lid. Made from high grade borosilicate glass, which is more heat resistant than any other commonly used glass. Now you can save the planet and enjoy your warm tea too. With fashionable silicone sleeve for drop protection and heat insulation. Content 550ml.

Print Technique : UV, SC, ENG  
Product Size : 24 x ø6.8 cm

Preferred Print Location : Top Max Print Size : 45 x 40 mm  
Packing Details : 49 X 33 X 26 cm; 24 pcs/carton; gw/nw: 14.5 kg/carton



# ECO FRIENDLY MISCELLANEOUS GIFTS



eco-neutral



## CUTLERY SET



HELEN 197 - HELLA

**eco-neutral** A compact and convenient alternative to single-use plastic cutlery. Make a natural choice with our Wheat Straw Cutlery Set consisting of a knife, spoon and fork packed in a convenient wheat straw box.

Print Technique : UV, SC  
Product Size : 20.3 x 5.5 x 2.2 cm

Preferred Print Location : Case  
Packing Details : 32 X 24 X 49 cm ; 100pcs /carton ;

Max Print Size : 190 X 50 mm  
gw/nw: 7.4 / 7.8 kg / carton

READY STOCK



Made from Beech Wood



- 01 Large nose pliers
- 02 Standard pliers
- 03 Wire cutter
- 04 Serrated blade
- 05 Knife
- 06 Phillips screwdriver
- 07 Bottle opener
- 08 Flat screwdriver
- 09 Small flat screwdriver
- 10 Can opener
- 11 Saw
- 12 File
- 13 Large screwdriver

MTXD 101 - WOOD MULTITOOL

**XD COLLECTION** Strong and durable multitool with 13 functions. With beech wood case and high quality stainless steel tools. Tools include: Long nose plier, standard plier, wire cutters, serrated blade, bottle opener, large flat screwdriver, phillips screwdriver, knife, saw, small flat screwdriver, can opener, medium flat screwdriver, file. Packed in gift box.

Print Technique : SC,UV, ENG  
Product Size : 2.1 X 4.6 X 9.8 cm

Preferred Print Location : Front  
Packing Details : 40 X 19 x 29.50 cm ; 40 pcs /carton ;

Max Print Size : 40 x 10 mm  
gw/nw: 11.5 kg / carton



# REUSABLE NON-MEDICAL FACE MASK

**50X**

REUSABLE & MACHINE  
WASHABLE WITH  
GUARANTEE OVER 99%  
ANTIBACTERIAL RATE

**100%**

ECO-FRIENDLY COTTON

**> 95%**

BACTERIAL FILTRATION  
EFFICIENCY (BFE)  
FOR PARTICLES > 3 MICRO  
METER



Eco  
Friendly  
Cotton



ADJUSTABLE  
EARLOOPS  
ONE SIZE FITS ALL



MCMS 105 - REPS

SANTHOME  
PROTECT

Reusable Non-Medical 2 layer cotton face mask that is treated with Silvadur TM (A DuPont product) antibacterial agent. Comfortable daily use masks that protect you and do not harm the environment!

Print Technique : SC , HT

Preferred Print Location : Right Side

Max Print Size : 60 X 40 mm

Packing Details : 57 x 40 x 20 cm ; 600 pcs / carton ; gw / nw : 9.20 kg / carton

READY STOCK

## eco friendly / cost effective / all purpose bags



White / green



White



RPET 001 - ANOKIS

Recycled RPET Bag

Print Technique : SC

Preferred Print Location : Front & Back

Max Print Size : 260 x 300 mm

Product Size : 38 x 30 x 12 cm

Packing Details : 34 x 42 x 40 cm ; 100 pcs/carton ; gw/nw : 8 kg/carton



BPMK 127 - BRAWLEY

Bag made from 100% organic cotton material with natural color finish. With reinforced short handles of 35cm in green color, gussets and stitched finishing. Takes up to 9kg weight. 145gsm.

Print Technique : SC, HT

Preferred Print Location : Front

Max Print Size : 360 x 340 mm

Product Size : 40 x 40 x 10 cm

Packing Details : 38 x 44 x 54 cm ; 200 pcs / carton ; gw / nw : 17 kg / carton



### DO YOU KNOW THE WATER FOOTPRINT OF COTTON?

It takes **20,000 Liters of water** to produce 1kg of cotton fiber.

Source: WWF

Continue reading



READY STOCK



300 GSM  
Sturdy Fabric

This Bag Saved

**-4,000  
Litres**  
Water



300 GSM  
Sturdy Fabric

This Bag Saved

**-10,000  
Litres**  
Water



**CTEN 425 - BORKUM**  
Eco neutral GRS-Certified Recycled Cotton Beach Bag in Natural color - Least / almost NIL Impact on environment  
Print Technique : SC  
Max Print Size : 330 x 420 mm  
Preferred Print Location : Front  
Product Size : 40 x 47 x 17 cm



**DBEN 430 - PUEBLA**  
Eco neutral GRS-Certified Recycled Cotton Duffel Bag in Natural color - Least / almost NIL Impact on environment  
Print Technique : SC  
Max Print Size : 180 x 160 mm  
Preferred Print Location : Front Pocket  
Product Size : 49 x ø26 cm

- > Outside Zipper pocket for quick access & safety
- > Easy to wash-&-clean





~~1,200 - 5,000~~  
Litres of water  
needed to  
make 1 normal  
Cotton Bag

Move to →

0.02 - 0.05  
Litres of water  
needed to  
make an eco neutral  
Recycled Cotton Bag

Please choose responsibly!



This Bag Saved

**-1,200**  
Litres  
Water



Natural



Black



Blue

**140 GSM**  
Light & Durable



ABLAR

CTEN 421 - Natural CTEN 422 - Black CTEN 423 - Blue

Eco neutral GRS-Certified Recycled Cotton Tote bag 140 gsm

Print Technique : SC

Preferred Print Location : Front

Max Print Size : 350 x 320 mm

Product Size : 42 x 36 cm



READY STOCK

Black

This Bag Saved

**-4,000**  
Litres  
Water



Natural

**300 GSM**  
Sturdy Fabric



DARGUN

CTEN 427 - Natural CTEN 428 - Black

Eco neutral GRS-Certified Recycled Cotton Tote Bag with Bottom Gusset 300 GSM

Print Technique : SC

Preferred Print Location : Front

Max Print Size : 300 x 320 mm

Product Size : 42 x 38 x 10 cm



# COTTON BAGS & POUCHES

White



White



eco-neutral



Natural



Natural



READY STOCK



**CT 001 - STRUM**

Print T : SC, HT      Print L : Front & Back  
Max Print Size : 320 x 340 mm      Product Size : 42 x 38cm  
Packing Details : 46 x 46 x 48 cm ;  
250 pcs/carton; gw/nw: 19.50 kg/carton



**CT 101 - TSIO**

Print T : SC, HT      Print L : Front & Back  
Max Print Size : 260 x 300 mm      Product Size : 38 x 32 x 12cm  
Packing Details : 46 x 46 x 48 cm ;  
150 pcs/carton; gw/nw: 20 kg/carton



**CT 501 - CAPTRU**

eco-neutral Cotton wallet with Foldable shopping bag  
Print T : SC, HT      Print L : Pouch & Bag  
Max Print Size : (Bag) 270 x 290 mm  
(Pouch) 80 x 50 mm  
Product Size : 12 x 11 x 3.5 cm (Pouch) 32 x 33 (Bag)  
Packing Details : 46 x 46 x 48 cm ;  
225 pcs/carton; gw/nw: 18.375 kg/carton



Green



Blue



**BREA**

**BPMK 128 - Blue    BPMK 130 - Green**

Bag made from 100% cotton material and in combination of body of natural color and handles in a varied range of bright tones. With 70cm long handles and stitched finishing. Takes up to 7kg of weight. 105 gsm.  
Print Technique : SC, HT      Preferred Print Location : Front  
Max Print Size : 330 x 350 mm      Product Size : 37 x 41 cm  
Packing Details : 45 x 40 x 30 cm ;  
250pcs / carton ; gw / nw : 12 kg / carton



**CT 301 - SUSINOC**

Cotton Toiletry Pouch  
Print T : SC, HT      Print L : Front  
Max Print Size : 190 x 70 mm  
Product Size : 23 x 13 x 5cm  
Packing Details : 56 x 56 x 38 cm ;  
100 pcs/carton gw/nw: 20.8 kg/carton



**CT 601 - TRUIO**

Cotton Tablet Case  
Print T : SC  
Print L : Front  
Max Print Size : 230 x 110 mm  
Product Size : 29 x 22 x 5 cm



eco friendly / cost effective / all purpose bags



White



Natural



JT 101 - SISMAC

Print Technique : SC, HT Preferred Print Location : Front & Back  
Max Print Size : 250 x 300 mm Product Size : 38 x 30 x 12 cm  
Packing Details : 56 x 56 x 38 cm ; 100 pcs /carton ; gw/nw: 21.40 kg / carton



Natural

Front Pocket for convenience;  
Option of 3 colors



Black



Blue



MONCLOVA

JTEN 432 - Natural JTEN 433 - Black JTEN 434 - Blue

Jute Bag with Front Pocket  
Print Technique : SC, HT Preferred Print Location : Front & Back  
Max Print Size : 380 x 230 mm Product Size : 44.5 x 35.5 x 11.5 cm



Natural



White



JT 201 - KRISKIT

Print Technique : SC, HT Preferred Print Location : Front & Back  
Max Print Size : 380 x 270 mm Product Size : 33 x 43 x 15 cm  
Packing Details : 56 x 56 x 38 cm ; 80 pcs /carton ; gw/nw: 20.4 kg / carton



CTEN 101 - BAJA

Cotton Shopping Bag with Jute Gusset  
Print Technique : SC, HT Preferred Print Location : Front  
Max Print Size : 280 x 230 mm Product Size : 30 x 37 x 12.5 cm  
Packing Details : 34 x 42 x 40 cm ; 100 pcs/carton ; gw/nw: 8 kg/carton

READY STOCK



# NON WOVEN SHOPPING BAGS

*Eco friendly / cost effective / ideal for exhibitions*



Black



Royal Blue



White



Navy Blue



Cream



Red

### NW 001 V - NONWOA SOLID

Print Technique : SC, HT

Preferred Print Location : Front & Back

Max Print Size : 260 x 300 mm

Product Size : 38 x 30 x 10 cm

Packing Details : 68 x 42 x 37.5 cm; 250 pcs/carton; gw/nw: 11.3 kg/carton



White/R.Blue



White/Grey



White/Black



White/Green



White/Navy



White/Orange



White/Red



White/Maroon

### NW 001 V - NONWOA EDGE

Print Technique : SC, HT

Preferred Print Location : Front & Back

Max Print Size : 260 x 300 mm

Product Size : 38 x 30 x 10 cm

Packing Details : 68 x 42 x 37.5 cm; 250 pcs/carton; gw/nw: 11.3 kg/carton



White



Black

### NW 001 H - LUKAOK

Print Technique : SC, HT

Preferred Print Location : Front & Back

Max Print Size : 390 x 250 mm

Product Size : 33 x 43 x 12 cm

Packing Details : 74 x 47 x 37.5 cm; 250 pcs/carton; gw/nw: 14 kg/carton



READY STOCK



**INCREASED FOCUS ON  
REDUCING  
THE USE OF  
PLASTIC**

According to United Nations Environment Programme Each year, more than 8 million tonnes of plastic ends up in the oceans, wreaking havoc on marine wildlife, fisheries and tourism, and costing at least \$8 billion in damage to marine ecosystems. Up to 80 per cent of all litter in our oceans is made of plastic.

“waste is one the greatest environmental challenges facing the world, which is why protecting the marine environment is central to our agenda The Financial Times, 2018”



KOSZEJ

CTEN 103 - Grey CTEN 104 - Blue

Draw String Bag in Herringbone Weave

Print Technique : SC, HT Preferred Print Location : Front and Back Max Print Size : 300 x 400 mm

Product Size : 36 X 46 cm Packing Details : 46 x 46 x 38cm; 100 pcs/carton; gw/nw: 12.53 kg/carton



Blue

eco-neutral



Grey

READY STOCK



**citrus**

Natural

eco-neutral



**Padre's**  
Since 1989



BPMK 110 - PAPAKURA

Drawstring backpack in 100% cotton fabric with soft finish in natural color. With matching color self closing strings. 110gsm cotton.

Print Technique : SC, HT Preferred Print Location : Front, Back

Max Print Size : 300 x 350 mm Product Size : 37 x 41 cm

Packing Details : 33 X 44 X 45 cm ; 14.5 kg Pcs: 250/ carton



White

CT 401 - ZITUTE

eco-neutral Cotton Draw String Bags

Print Technique : SC, HT Preferred Print Location : Front & Back

Max Print Size : 330 x 300mm Product Size : 34 x 42cm

Packing Details : 46 x 46 x 48cm; 200 pcs/carton; gw/nw: 20.90 kg/carton



# BOBBY TECH

- > Solar Powerbank Backpack
- > Integrated Wireless Charger
- > Patented Fid Lock System
- > Anti-Theft Backpack Series - Regd. Design



READY STOCK

BGXD 621

Print Technique : SC, HT  
Product size : 41 X 27.3 X 16.5 cm

Preferred Print Location : Side  
Packing Details : 68 x 44 x 47 cm ; 6 pcs /carton ; gw/nw: 7.5/8.5 kg / carton

Max Print Size : 80 x 90 mm



Blue



Grey

Giftology



BARUTH

BPGL 674 - Black BPGL 675 - Grey BPGL 676 - Blue

Useful Backpack made out of GRS certified RPET material; Elegant design; User-friendly features

Print Technique : SC, HT Preferred Print Location : Front Max Print Size : 200 x 150 mm  
Product size : 42 X 31 X 16 cm Packing Details : 46 x 35 x 47 cm ; 10 pcs /carton ; gw/nw: 12/13 kg / carton



**THIS BAG CARES FOR BOTH THE ENVIRONMENT AND YOUR HYGIENE**

**Features**

- RPET Antimicrobial External fabric
- UV-C Sterilization pocket on the front
- Fits laptop upto 15.6"
- Integrated External USB Output
- Padded interior laptop, tablet and accessory pockets
- Back panel with elastic strap to slip over trolley handles

**SANTHOME**



External Fabric Created From 100% Post-Consumer Recycled Plastic



**READY STOCK**

UV-C Sterilizing Pocket

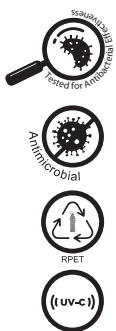

- External Fabric made from Recycled Post-consumer plastic
- UV-C Sterilizing pocket to Sanitize small articles as phone, wallet, currency etc On-the-go
- Outside material treated with Anti-Bacterial Technology
- Large capacity backpack with practical pockets

**BPSN 795 - CASTILE**

**SANTHOME PROTECT** Make the daily commute a little bit easier and a lot more safe with this laptop backpack with UV Sterilizing pocket. The bag is made from durable Anti-Bacterial 1680D RPET polyester fabric with rich PU details and features a pocket on the front in which you put any article for 5 min and get it out disinfected with UV-C technology. The built-in USB A cable needs to be connected to the powerbank (not included) in order to power the UV-C system. In addition to the roomy main compartment, this backpack features a padded 15.6" laptop pocket and an additional zipper pocket to hold your other daily essentials. Other features of this backpack include an USB output, and a side water bottle pocket.

Print Technique : SC  
Product size : 47 x 14 x 29 cm

Preferred Print Location : Front Top      Max Print Size : 100 x 40 mm  
Packing Details : 65 x 52 x 35 cm ; 10 pcs /carton ; gw/nw: 9.5 kg / carton



A5

NBEN 103 - BORSA

eco-neutral Borsa is an eco friendly notebook with 160 pages each 80 gsm and made from a combination of fabric and cork materials. Also includes a matching Eco Friendly pen made from Cork and Eco-Friendly Wheat Straw. Packed in a gift box.

Print Technique : UV,SC Preferred Print Location : Front Bottom Max Print Size : 60 x 110 mm (Book) 40 x 7mm (Pen clip)  
Box Size : 22 x 16 x 1.8 cm Packing Details : 50.8 x 35 x 25.8cm; 48 pcs/carton; gw/nw: 15.5 kg/carton

READY STOCK



A5

NBEN 102 - CORQ

eco-neutral Notebook made out of natural cork with 160 pages of 80g. With black page divider and black elastic band. Including bamboo pen with stylus tip and ballpoint. Eco-friendly set packing box.

Print Technique : UV Preferred Print Location : Book Bottom Center Max Print Size : 140 x 205 mm (Book) 25 x 6mm (Pen)  
Box Size : 21 x 25 x 1.7 cm Packing Details : 44.5 x 43 x 26.5 cm; 40 pcs/carton; gw/nw: 15 kg/carton



- > 80 Pages Ruled Notebook
- > Eco-Friendly Cover
- > A5 Size
- > Value Deal !!

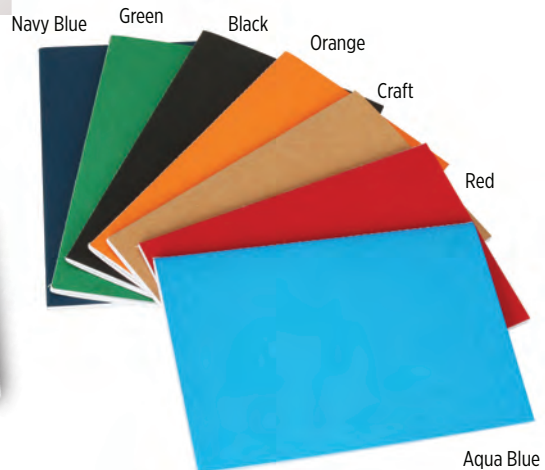

VINICA

NBGL 215-Black NBGL 216-Craft NBGL 217-Aqua Blue NBGL 218-Navy Blue NBGL 219-Red

NBGL 220-Green NBGL 221-Orange

eco-neutral Classic design notebook with cardboard covers in eye-catching colors and smooth finish. With matching color seams on side and 80 ruled pages.

Print Technique : SC, UV Preferred Print Location : Front Max Print Size : 100 x 170 mm  
Product Size : 20.5 x 14 x 0.5 cm





**SANTHOME**  
eco lifestyle

CREATIVE

QUALITY

Earth is a wonderful home and should be treated with respect. At the same time, the brand Santhome creates beautiful design. The Bamboo Notebook embodies both of these philosophies -- bamboo is actually a grass, that grows quickly and has the strength of a hardwood. Its bold design makes it a powerful tool that communicates your commitment to sustainability!



READY STOCK



- > 256 Pages
- > Combination Of Squared, Ruled & Blank Pages
- > Express Your Commitment To Sustainability
- > Eco-Friendly !!

Laser Engrave Your Logo & Be Part Of This Vision !

NBSN 201 – GANDRA

SANTHOME Back to nature with this eco-friendly bamboo cover notebook with 128 sheets/256 pages in ivory color each 100 gsm. Inner pages include a combination of ruled, grid (squared) and blank pages. Natural bamboo ensures no two notebooks look the same. Packed in a eco-friendly gift box.  
 Print Technique : UV, SC, ENG Preferred Print Location : Top Max Print Size : 110 x 160 mm  
 Product Size : 18.5 x 13 x 2.2 cm Packing Details : 13 X 18.8 X 2.2 cm; 24 pcs/carton; gw/nw: 14.5 kg/carton



# ECO-FRIENDLY/ ANTI-BACTERIAL NOTEBOOKS & FOLDERS

## SANTHOME PROTECT

- Cover made from recycled plastic (rPET) & treated with silver-ion Anti-Bacterial Technology
- FSC Certified Paper
- A5 Ruled Notebook, 160 Pages

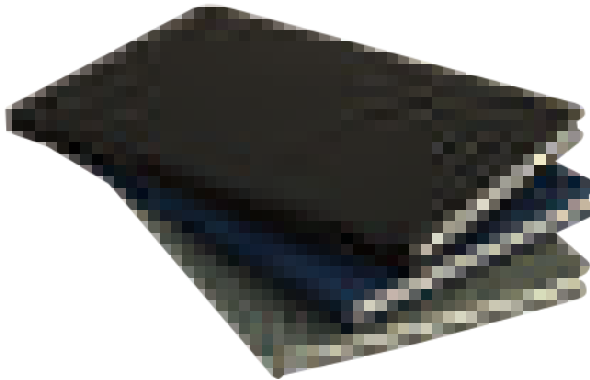

Black  
Navy Blue  
Grey

### BOOKMARK



**This Notebook Cares for You**  
Functional & Safe notebook that protects you against harmful microbes that may adhere to its surface. Kills 99.9% bacteria using Silver-Ion Technology.

**This Notebook Loves Trees**  
Paper used to make this notebook is FSC certified. FSC® certified paper is paper that has been harvested in a socially and environmentally responsible manner. By using a FSC certified paper, you are helping to ensure our forests are alive for generations to come.

**This Notebook Cares for the Environment**  
The fabric cover of the notebook is made using recycled post-consumer plastic. The rPET material itself is sourced from a Global Recycled Standard (GRS) certified factory. GRS certificate communicates truth in materials and support for a circular economy that reduces waste by using it to make new products.

**A notebook that is proudly made and a notebook you would proudly use!**



ORSHA

NBSN 341 - Black    NBSN 342 - Grey    NBSN 343 - Navy Blue

**SANTHOME PROTECT** A notebook that cares for you and for the environment. The cover of the notebook is made from recycled plastic (rPET) in a GRS Certified factory that complies with global recycling standards and is treated with anti-bacterial technology to provide protection against the growth of harmful bacteria. The paper used in this notebook is acid-free and FSC Certified. A5 notebook with 160 ruled pages each of 70 gsm

Print Technique : SC, HT

Preferred Print Location : Front

Max Print Size : 120 X 200 mm

Product Size : 14 X 21 X 1.4 cm

Packing Details : (Black) 36.5 X 33 X 24 cm; (Black = 50 pcs) / carton; (Grey& navy Blue = 59 pcs / carton gw / nw : 13.3 kg / carton

READY STOCK



Black

A4

Red



**FO 3341 - SORBUS**

A4 folder with a button closure made from Eco-friendly material. Consists of a notepad with 70 pages, matching coloured pen and a pocket to keep documents and business cards.

Print Technique: SC Preferred Print Location: Center  
Max Print Size : 300 x 140 mm

Product Size : 22.5 x 31.5 x 2 cm

Packing Details : 51 x 35 x 34.5 cm; 30 pcs/carton; gw/nw: 17kg/carton



Craft Exterior

Blue Exterior



A4

**FO 3340 - JUDAS**

A4 folder with a button closure made from Eco-friendly material. Consists of a notepad with 40 pages, pen loop and pocket to keep documents and business cards.

Print Technique : SC Print Location : Top Right  
Max Print Size : 130 x 100 mm

Product Size : 23.5 x 32.5 x 1.5 cm

Packing Details : 52 x 38.5 x 35 cm; 40 pcs/carton; gw/nw: 14.5 kg/carton



**EFEN 108 - Craft**

**eco-neutral** Notepad that is ideal for meetings!! Consists of 70 sheets of 70 gsm paper, sticky notes to mark important points, business card pocket that can hold up to 10 cards and recycle material ballpoint pen.

Print Technique : SC, UV Print Location : Center  
Max Print Size : 60 x 40 mm

Product Size : 14.5 x 11.5 x 1.5 cm

Packing Details : 35.5 x 32 x 21.5 cm; 100 pcs/carton; gw/nw: 11 kg/carton





# eco-neutral



- Pen
- Spirit Level
- Ruler (7 cm)
- Screw Driver
- Stylus Tip
- Solid Bamboo



WIEN 876 - WILTZ

**eco-neutral** Multifunction bamboo pen with ruler (7cm) , spirit level, screw driver, stylus tip and ballpoint. Made from bamboo with aluminium clip. German Documental Ink (Blue)

Print Technique : UV, SC, ENG Preferred Print Location : Barrel Max Print Size : 25 X 10 mm  
 Product Box Size : 2.3 x 5.3 x 17 cm Packing Details : 27 x 31 X 37 cm ; 100 pcs / carton ; gw / nw : 15.5 kg / carton



READY STOCK



WIXD 525 - BAMBOO PEN IN BOX

**XD COLLECTION** Bamboo ballpoint pen with silver finish in bamboo box.

Print Technique : UV, SC, ENG Preferred Print Location : Barrel  
 Max Print Size : 25 X 10 mm Product Box Size : 2.3 x 5.3 x 17 cm  
 Packing Details : 27 x 31 X 37 cm ; 100 pcs / carton ; gw / nw : 15.5 kg / carton





# ECO-FRIENDLY WRITING INSTRUMENTS



### STMK 126- CIREBON

Elegant ball pen with natural bamboo wood body and silver finish details. Presented in an individual black cardboard box.  
Print T.: SC, ENG, UV      Print Location.: Barrel  
Max Print Size: 50 x 6mm      Product Size: 14 x ø1 cm  
Packing Details: 32 X 33 X 68 cm ; 14.5 kg Pcs: 1000/ carton

### STMK 127- SALATIGA

Set of push-up mechanism ball pen and mechanical pencil made in an original combination of natural bamboo wood and metallic finish accessories in shiny silver color. Presented in a cardboard case in wooden finishing. 0.7 mm Leads Included.  
Print T.: SC, ENG, UV      Print Location.: Barrel  
Max Print Size: 60 x 6 mm      Product Size: 13.8 x ø1.1 cm  
Packing Details: 26 X 43 X 55 cm ; 14 kg Pcs: 300/ carton

### STMK 128- SUKABUMI

Eco- friendly bamboo pen with touch stylus. Blue ink. Jumbo refill.  
Print Technique : SC, ENG, UV      Print Location : Barrel  
Max Print Size : 60 x 6 mm      Product Size: 13.8 x ø1.1 cm  
Packing Details : 20 X 31 X 45 cm ; 10 kg Pcs: 1000/ carton

READY STOCK

## eco-neutral

Wheat Straw Trims



Bamboo Body



SERANG  
WIEN 101 - Natural    WIEN 102 - Blue    WIEN 103 - Green

**eco-neutral** Eco-Friendly push-up mechanism ball pen. Body in bamboo, with accessories in wheat straw, to encourage the use of natural raw materials.  
Print Technique : UV, SC, ENG      Preferred Print Location : Barrel      Max Print Size : 6 x 50 mm  
Product Size : 14 x ø1 cm      Product Size : 15 x ø1 cm      Product Size : 16 x ø1 cm  
Packing Details : 48 x 31 x 22 cm ; 1000 pcs /carton ; gw/nw: 9.5 kg /carton



EFEN 220 - Couvin

**eco-neutral** Cardboard cube with lid. Folds out to reveal small sticky notes in 5 different colours (25 sheets per color), included 30 paper clips, 4 pen holder slots, business card slots, a mobile stand and most importantly, a wireless charger. The Wireless charger has a 5W output. A perfect tech desk accessory for the modern desk!!

Print Technique : UV, SC

Product Size : 10.5 x 10 x 10.5 cm

Preferred Print Location : Front Max Print Size : 90 x 90 mm 44 x 17mm

Packing Details : 44.5 X 27 X 42.5 cm; 75 pcs/carton; gw/nw: 15 kg/carton



EFEN 109 - OOLO

**eco-neutral** A box that opens up and becomes a useful desk organizer. Includes 50 paper clips, 2 sets of 100 notepages and neon strips in 5 colours. This unique and compact designed product will surely grasp the attention of your customers.

Print Technique : SC, UV

Preferred Print Location : Top Max Print Size : 70x70 mm

Product Size : 8.5 x 8 x 8.5 cm

Packing Details : 44.5 x 27 x 42.5cm; 75 pcs/carton; gw/nw: 15 kg/carton

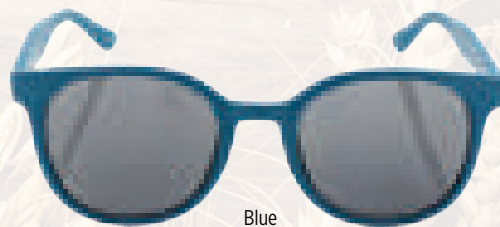

Blue



Green



WHEAT STRAW

PRILEP

SGEN 101 - Blue SGEN 102 - Green

**eco-neutral** Sunglasses with frame made out of wheat straw fibre. Packed in kraft paper box. With UV 400 glasses.

Print Technique : Sc

Preferred Print Location : Side

Max Print Size : 50 x 5mm

Product Box Size : 3 X 5.5 X 14.5 cm

Packing Details : 65 X 29.5 X 41 cm ; 200 pcs / carton ; gw / nw : 10 kg / carton



## KIDS STATIONERY GIFTS (ECO)

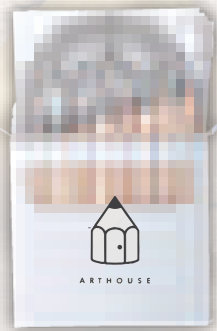

### STMK 136 - TARAKAN

Set of pencils and coloring sheets with mandala designs to color and relax. Includes 12 hexagonal body pencils and 12 sheets with different designs. Presented in cardboard box with window. 12 Pencils and 12 Sheets Included

Print Technique : SC, UV Preferred Print Location : Front Cover  
Max Print Size : 65 x 35 mm Product Size : 9 x 9 x 1 cm  
Packing Details : 29 x 22 x 48 cm ; 300pcs /carton ; gw/nw: 13kg / carton



### STMK 137 - SORONG

Set of 6 crayons in natural cardboard box. With cylindrical body in varied colors. Including crayons in 6 colors.a

Print Technique : SC, UV Preferred Print Location : Front Cover  
Max Print Size : 35 x 50 mm Product Size : 5.3 x 9 x 0.9 cm  
Packing Details : 26.5 x 21 x 28.5 cm ; 250pcs /carton ; gw/nw: 10kg / carton

READY STOCK

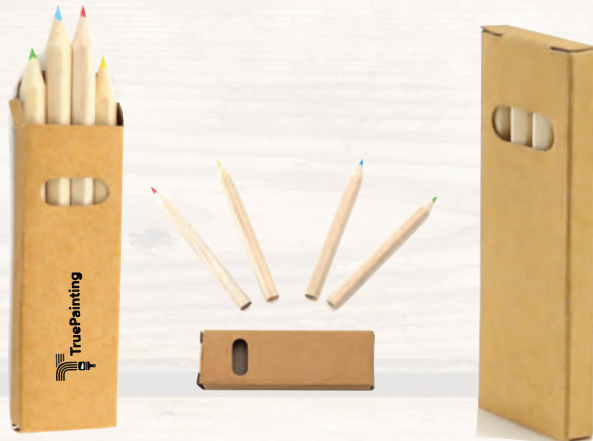

### STMK 139 - BATU

Box of 4 wooden pencils with hexagonal body and in natural finish. Presented in natural cardboard box with window.

Print Technique : SC, UV Preferred Print Location : Front Cover  
Max Print Size : 40 x 20 mm Product Size : 3 x 9 x 0.8 cm  
Packing Details : 27 x 23.5 x 47.5 cm ; 1000pcs /carton ; gw/nw: 12kg / carton



### STMK 102 - TERVEL

Set of 6 pencils in natural cardboard box with window. Wooden pencils with hexagonal body in natural finish and in a wide range

Print Technique : UV, SC Preferred Print Location : Front Cover  
Max Print Size : 35 X 55 mm Product Size : 4.5 X 9 X 0.8 cm  
Packing Details : 24.5 X 24.5 X 37.5 cm ; 500 pcs / carton ; gw / nw : 9 kg / carton

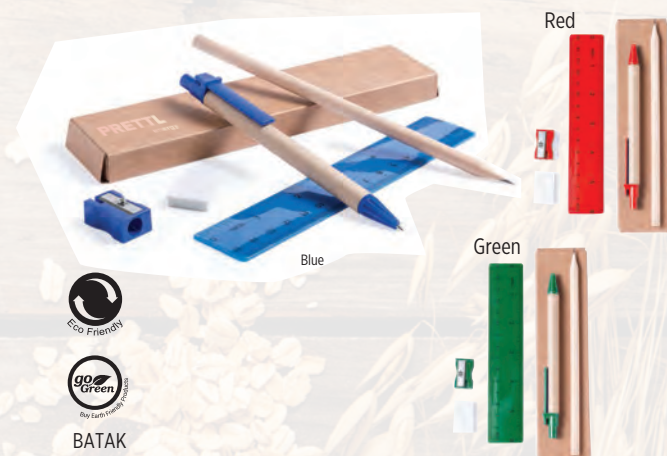

BATAK

### STMK 101 -Blue STMK 141 - Red STMK 142 - Green

Set of 5 pieces presented in natural cardboard box. Includes push-up mechanism ball pen and blue ink in recycled cardboard, wooden cylindrical body pencil, pencil sharpener, rubber and 15 cm ruler.

Print Technique : UV, SC Preferred Print Location : Box  
Max Print Size : 100 X 30 mm Product Size : 4.5 X 17.7 X 1.5 cm  
Packing Details : 38 X 34 X 48 cm ; 400 pcs / carton ; gw / nw : 14 kg / carton



### GMMK 103 - BYALA

Classic skill game mikado with 41 wooden sticks. Presented in wooden box with sliding cover.

Print Technique : ENG, SC Preferred Print Location : On the side  
Max Print Size : 100 X 20 mm Product Size : 19.3 X 2.5 X 4.1 cm  
Packing Details : 47 X 21 X 28 cm ; 100 pcs / carton ; gw / nw : 10 kg / carton



- 183 x 61 cm Size , 0.5 cm Thick
- Cork is a renewable material
- Stay fit, Stay healthy
- Employees (HR) gift



**WZEN 166** - ARCALIS

Cork Yoga mat - high end feel. TPE used in base material.

Print Technique : SC,HT

Product Size : 183 X 61 X 0.5 cm

Preferred Print Location : Pouch

Packing Details : 47 X 35 X 63.5 cm ; 12 pcs / carton ; gw / nw : 10.8/11.8 kgs / carton

Max Print Size: 200 X 50 mm

READY STOCK



**XANTHI**

**WZEN 165** - JUMPING ROPE (Skipping)

A cotton Jumping Rope with wooden Handle, in cotton pouch

Print Technique : SC

Preferred Print Location : Pouch



Max Print Size: 110 X 150 mm



# ECO COASTERS / KEYRINGS/ CARD HOLDERS



DTLC 801 - LUBLIN  
Square Wooden Coaster



DTLC 804 - PLOCK  
Round Cork Coaster



DTLC 803 - MALBORK  
Round Wooden Coaster



DTLC 802 - RADOM  
Square Cork Coaster

READY STOCK

## eco-neutral

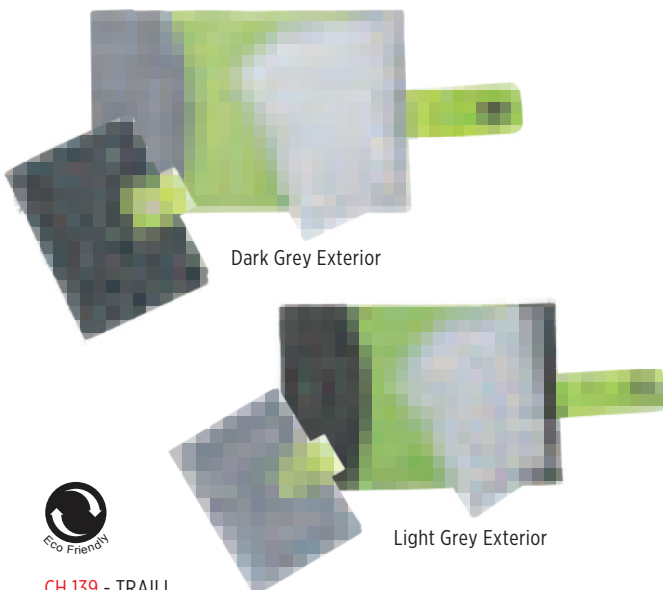

Dark Grey Exterior

Light Grey Exterior



CH 139 - TRAILL

eco-neutral Pocket Cards Holder in attractive color combinations with eco-friendly felt jacket

Print Technique : SC Preferred Print Location : Center  
Max Print Size: 50 x 90 mm Product Size : 8.5 x 11 x1 cm  
Packing Details: 54.5 x 27 x 30.5 cm; 200 pcs/carton; gw/nw: 7 kg/carton



BEECH WOOD



KCMK 102 - MARFA

Smart nature line keychain. Obtained from cuts of beech wood, being all of them different and unique, each one with its own texture, thickness and color. With a wide printing area.

Print Technique : SC, ENG, UV  
Preferred Print Location : Front/Back  
Max Print Size : 40 x 24 mm Product Size: Variable  
Packing Details: 40 x 36 x 40 cm  
; 800 pcs / carton ; gw / nw : 13 kg / carton





## MAGNETIC is the new trend!

Snap on this magnetic wireless charger to the back of your iPhone 12 to charge your device. The magnets are perfectly aligned for the correct charging position. This wireless charger is also compatible with all Qi devices (iPhone 8 and up and latest android devices). This ensures this can be used as a regular wireless charger for other phones as well.



- 15W fast charging for iPhone 12
- 15W means 3 times faster wireless charging
- Bamboo - eco friendly
- MAG/SAFE compatible



ITWC 156 - DOMITZ

@MEMORII Domitz is a Magnetic wireless charger with a bamboo casing - 15W wireless capacity for super fast charging.

Print Technique : SC, UV, ENG  
Product Size : 6 X 6 X 0.8 cm

Preferred Print Location : Top

Max Print Size : 40 X 40 mm

Packing Details : 43.5 x 42.5 x 25.5 cm ; 200 pcs / carton ; gw / nw : 12.5/13.5 kgs / carton

READY STOCK



- Eco Friendly RPET Material
- 5 Watts Wireless Charger
- With Mouse pad, Desk Stand
- Elegant Fabric gives a Rich appearance
- Folds completely, hence a Travel-friendly accessory



ITWC 153 - GORI

Print Technique : SC, UV, ENG Preferred Print Location : Front & Back  
Max Print Size : (Front) 70 x 30 mm (Back) 260 x 30 mm  
Product Size : 22 X 28 cm



ITWC 154 - VANI

Print Technique : SC, UV, ENG Preferred Print Location : Front & Back  
Max Print Size : (Front) 70 x 30 mm (Back) 260 x 30 mm  
Product Size : 22 X 28 cm

- Eco Friendly RPET Material
- 10 Watts Wireless Charger
- With Mouse pad, Desk Stand
- Elegant Fabric gives a Rich appearance
- Folds completely, hence a Travel-friendly accessory



# RECYCLED ABS WIRELESS CHARGER & TWS EARBUDS



CERTIFIED BY INTERTEK  
Intertek - D26928-R2

- > Uses Recycled Claim Standard (RSC) plastic, certified by Intertek
- > 5W Wireless Charger made by recycling used plastics



ITWC 155 - HANKO

@memori Wireless charger made from RSC-certified recycled plastics. Micro USB input: DC5V.2A (max) W47-R Wireless charger Wireless output: 5W.

Print Technique : UV

Preferred Print Location : Top

Max Print Size : ø 75 mm

Product Size : ø10 X 0.7 cm

Packing Details : 36 x 22.5 x 27.5 cm ; 80 pcs / carton ; gw / nw : 7 / 8 kg / carton

READY STOCK



CERTIFIED BY INTERTEK  
Intertek - D26928-R2



- > Uses Recycled Claim Standard (RSC) plastic, certified by Intertek
- > Bluetooth TWS earbuds with 3 hour playtime + 22 hours backup playtime

## DEVICE LAYOUT

1. Charging pod left earphone slot

2. Charging status indicator light

3. Charging pod right earphone slot

4. Left earphone indicator

5. Touch button position of the right channel

6. Charging port of the charging case

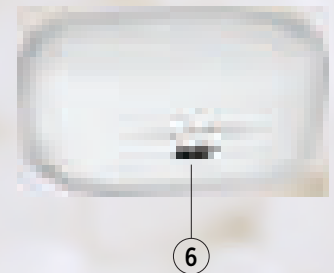

TWS made from recycled plastic

ITBH 852 - ALAVUS

@memori This highly useful wireless earbud is a proud possession - made from RSC-Certified recycled materials so that you use it guilt-free. The earbuds have a 40mAh built-in battery to provide 3 hours continuous playtime + 300mAh backup power in the case, with charging time less than an 1 hour.

Uses latest Bluetooth 5.0 for an effective operating range of 10 meters.

Print Technique : UV

Preferred Print Location : Top

Max Print Size : 20 X 30 mm

Product Size : 6.2 X 4 x 2.8 cm

Packing Details : 34 x 20.5 x 24 cm ; 120 pcs / carton ; gw / nw : 7/8 kg / carton



**XDDESIGN®**

- Elegant designer TWS
- CE-ROHS, MSDS, SCCP free
- Natural bamboo
- up to 3 hours play time
- including 3 size eartips



ITXD 742 - BEBRA

**XDDESIGN®** Let the music flow with these true wireless earbuds in charging case. The bamboo earbuds have a 35 mAh battery and can be re-charged in the 500 mAh charging case within 1 hour. With auto pairing function so easy to pair to your mobile device. Playing time on medium volume about 3 hours. With BT 5.0 for optimal connection. Operating distance up to 10 metres. With pick up and mic. Including 3 size silicone ear tips. Bamboo and ABS material.

Print Technique : UV, ENG Preferred Print Location : Top of Box Max Print Size : 40 X 10 mm  
 Product Size : 2.9 x 3.8 x 8.1 cm Packing Details : 26.5 X 33.5 X 58.5 cm; 100 pcs / carton ; gw / nw : 8.8 kg / carton

**READY STOCK**



- Natural Bamboo Material
- LED Available Power Display
- 6000 mAh Power Bank; 5W Wireless Charger
- Dual USB Input ; Type-C & Micro USB Output



ITPB 825 - COMRAT

**@MEMORII** Keep your phone charged with this eco 5W wireless powerbank. The powerbank comes with 2 charging options: wireless 5W charging, and dual regular USB port 2A output for fast charging. The casing is made out of durable bamboo. Wireless charging compatible with all Qi enabled devices like Android latest generation, iPhone 8, 8S and X. Input: 5V/2A (Micro in), USB output: 5V/2A Type-c input: 5V/2A, Wireless output: 5W (5V/1A)

Print Technique : UV, SC, ENG Preferred Print Location : Front Max Print Size : 60 X 90 mm  
 Product Size : 14 X 7.2 X 1.45 cm Packing Details : 34.5 X 17 X 13.5 cm; 28 pcs / carton ; gw / nw : 4.75 kg / carton

# Biomaster

## Antimicrobial protection

### How effective is Biomaster?

Very. Biomaster is proven to inhibit the growth of microbes by up to 99.99%.

### Is Biomaster safe?

Yes. It is based on silver ion technology, recognised for centuries with no harmful effects. Biomaster is used in medical, food and water applications.

### How long is Biomaster effective for?

Biomaster is tested to ISO standards and effective for the intended lifetime of the product it's added to. It is built-in and doesn't wear off or leach out.

### Does Biomaster affect a product in any way?

No. You can't see, smell or even taste Biomaster.

### Can a Biomaster-treated polymer be recycled?

Yes, it can be recycled effectively without any complications.

### Does Biomaster use nano-silver technology?

No. We don't use nano technology due to ongoing safety concerns.

### Why is Biomaster better than other silver based antimicrobial additives?

Biomaster pioneered the use of antimicrobial additives, and remains the recognised leader and most trusted supplier of antimicrobial technology for polymers, textiles, paper, paints and coatings.

Scan this QR code to see how Biomaster works on the surface of the product to effectively protect you 24/7



Scan this QR code to learn more about the Anti-Microbial effectiveness and check certifications



## HOW DOES BIOMASTER WORK?

**1** Biomaster binds to the cell wall disrupting growth



**2** The Biomaster ions interfere with enzyme production stopping the cell producing energy



**3** Biomaster interrupts the cell's DNA preventing replication

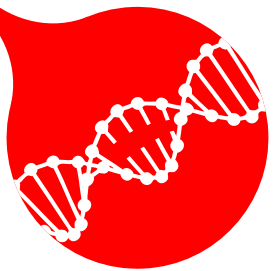

### How do I know if a product is Biomaster protected?

Unless it carries the Biomaster symbol, you don't. Ask before you buy it.

#### Products in this catalog with Added BIOMASTER TECHNOLOGY

1. @memorii Technology products with FSC certified Bamboo (Pages 60 to 62)
2. Santhome Genuine Leather articles (Pages 398 to 401)



[www.biomasterprotected.com](http://www.biomasterprotected.com)

Biomaster is a registered trademark of Addmaster (UK) Ltd.

Use biocides safely. Always read the label and product information.



READY STOCK



- ▶ Treated with Biomaster Antimicrobial Technology from UK
- ▶ FSC Certified Bamboo
- ▶ Fashion 3W speaker with 4 hours playtime



ITSP 162 - KOBRYN

@MEMORii Natural FSC Certified bamboo 3W speaker with built-in 500 mAh lithium battery. With playing time up to 4 hours on one single charge and operating distance of 10m using BT5.0. This product contains Biomaster antimicrobial technology that provides protection against the growth of harmful micro-organisms for the lifetime of the product.

Print Technique : SC, ENG  
Product Size : 12 x 4 x 8 cm

Preferred Print Location : Front Top

Max Print Size : 45 x 10 mm



# FSC BAMBOO ANTIMICROBIAL POWERBANKS



- > Treated with Biomaster Antimicrobial Technology from UK
- > FSC Certified Bamboo
- > Fashion 5000 mAh Wireless Powerbank

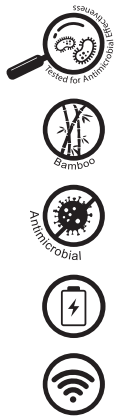

Micro Input    Type-C Input    USB Output

ITPB 836 - TUZLA

@MEMORI 5000 mAh heavy-duty powerbank (uses grade A battery) + 5W wireless charging, and made with FSC certified natural bamboo material and ABS for a great finish. Smart indicator shows you the remaining energy level. Uses advanced Biomaster anti-microbial technology that continuously protects against harmful micro-organisms for life. Input: Micro USB 5V/2A, Type-C 5V/2A. Output: USB 5V/2.4A. Wireless Output: 5W 5V/1A.

Print Technique : UV, SC, ENG    Preferred Print Location : Front    Max Print Size : 40 X 50 mm

Product Size : 1.5 X 6.5 X 10.1 cm

READY STOCK



USB Output 1    Type-C Input    USB Output 2

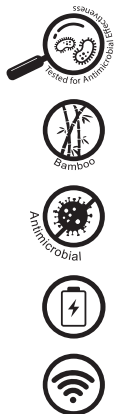

- > Treated with Biomaster Antimicrobial Technology from UK
- > FSC Certified Bamboo
- > Fashion 8000 mAh Wireless Powerbank



ITPB 837 - ASKAS

@MEMORI 8000 mAh heavy-duty powerbank + 5W wireless charger, made with FSC certified natural bamboo material and ABS for a great finish. Smart indicator shows you the remaining energy level. Uses advanced Biomaster anti-microbial technology that continuously protects against harmful micro-organisms for life. Inputs: Micro USB 5V/2A, type C 5V/2A. Output: USB 5V/2.4A. Wireless output: 5W 5V/1A

Print Technique : UV, SC, ENG    Preferred Print Location : Front    Max Print Size : 60 X 50 mm

Product Size : 2 X 8 X 15 cm



- > Treated with Biomaster Antimicrobial Technology from UK
- > FSC Certified Bamboo
- > Fashion 5W Mini Wireless Charger



**ITWC 241 - POLIS**

@MEMORI Charge your mobile devices without connecting a cable with this ECO 5W wireless charger made from FSC Certified Bamboo and ABS with soft touch finish. Just place your mobile phone on the pad and wait for the charging notification to appear. This product contains Biomaster antimicrobial technology that provides protection against the growth of harmful micro-organisms for the lifetime of the product. Input: 5V/2A. Wireless output: 5V/1A. Including micro USB cable.  
 Print Technique : UV, SC, ENG Preferred Print Location : Front Max Print Size : 35 X 25 mm  
 Product Size : 6 X 6 X 0.9 cm

READY STOCK

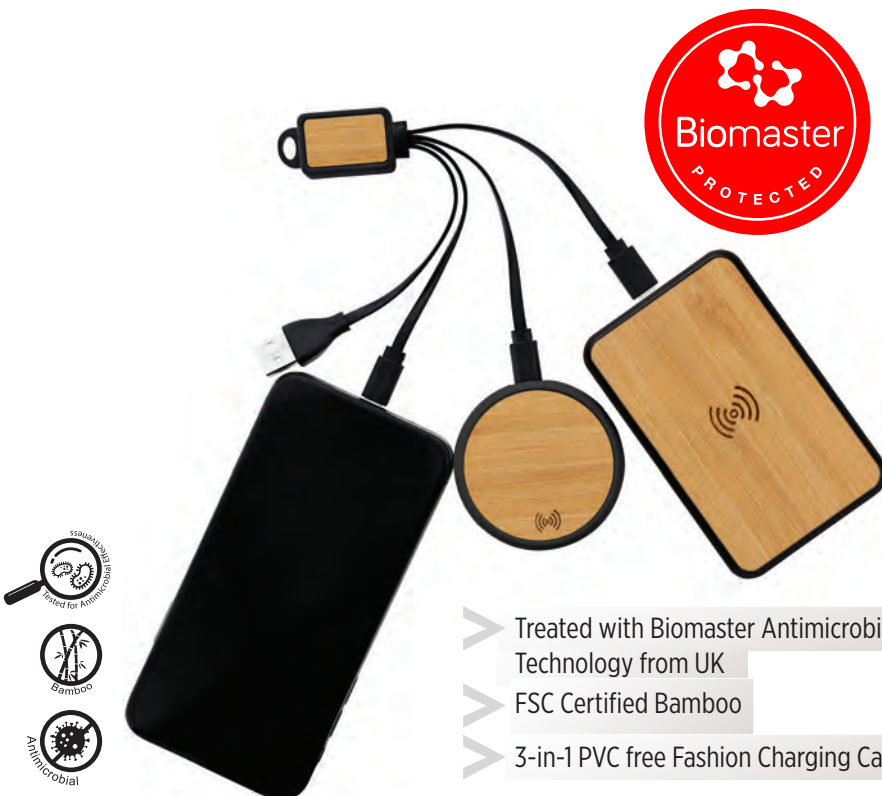

- > Treated with Biomaster Antimicrobial Technology from UK
- > FSC Certified Bamboo
- > 3-in-1 PVC free Fashion Charging Cable



**MTST 749 - ARANS**

@MEMORI Unique bamboo design 3-in-1 charging cable. The 15 cm cable is made from PVC free TPE material. USB Input and Type-C, Lightning and Micro USB Output. This product contains Biomaster antimicrobial technology that provides protection against the growth of harmful micro-organisms for the lifetime of the product. The bamboo used is FSC certified.

Print Technique : UV, SC, ENG Preferred Print Location : Front Max Print Size : 13 X 25 mm  
 Product Size : 17 X 2.2 X 1 cm







Black



Grey



Navy Blue

- > Designer Masks From XDDESIGN, Holland
- > VIRALOFF® Technology for Protection
- > Built for 1,000 Hours of Usage

READY STOCK



Layers



Filter

TALSI

HWXD 171 - Black    HWXD 172 - Grey    HWXD 173 - Navy Blue

**XDDESIGN®** This comfortable XD DESIGN face mask is made for every face. Lightweight three-layer design; The polyester front layer is treated with ViralOff®, a technology that removes 99% of the viruses in 2 hours. The middle layer contains a unique laboratory tested Hyproof® Nanofibre filter. This filter has a filtering efficiency of 95%. The inner layer is made of polyester. With three-dimensional chin structure and nose bridge for easy breathing. This set includes: 1 reusable and washable face mask, 5 reusable filters, 1 storage pouch. This device is not a medical device within the meaning of Regulation EU / 2017/745 (surgical masks) nor is it personal protective equipment within the meaning of Regulation EU / 2016/425 (filter masks type FFP2). Registered design®

Print Technique : SC , HT

Preferred Print Location : Right Side

Max Print Size : 60 X 40 mm

Product Size : 18 x 2 x 13.5 cm

Packing Details : 62 x 40 x 32 cm ; 180 pcs / carton ; gw / nw : 13 kg / carton



# FACE MASKS

READY STOCK

Navy Blue/Grey  
Medium



Grey/Black  
Kids



Navy Blue/Grey  
Kids



### MARONI

HWSN 192 K - Grey/Black - Kids    HWSN 193 K - Navy Blue/Grey - Kids    HWSN 193 - Navy Blue/Grey - Adults - Medium

**SANTHOME PROTECT** Reusable face mask with 6 layer triple filtration system. The comfortable design with adjustable nose clip, soft elastic ear loops and soft materials that prevent heat built-up ensures this mask can be used for a long time. Certified Bacterial Filtration Efficiency and Particulate Filtration efficiency of over 95% (>3 micron). Reusable upto 30 washes.

Print Technique : SC, HT    Preferred Print Location : Side    Max Print Size : (Medium) 40 X 50 mm (Kids)

Product Size : Medium 20 X 13 cm / Kids

Packing Details : 63.5 x 56 x 33 cm ; 500 pcs / carton ; gw / nw : 15.22 kg / carton

CUSTOMIZED / READY AVAILABLE



### KN95 MASK

Particulate Respiratory Mask

Composition- Non woven fabric 40%, melt blown fabric 30%, heat sealed cotton 30%

Standard GB2626-2006

Print Technique : HT    Preferred Print Location : Side    Max Print Size : 35 X 35 mm



### 3D Protective Mask - Non Medical Disposable

Filtration > 98% | Adjustable Nose Clip | Secure Fit 3D Design | Extra Soft Chin Cover | Single Use Mask

Print Technique : HT    Preferred Print Location : Side    Max Print Size : 35 X 35 mm



# REUSABLE NON-MEDICAL FACE MASK

**50X**

REUSABLE & MACHINE WASHABLE WITH GUARANTEE OVER 99% ANTIBACTERIAL RATE

**100%**

ECO-FRIENDLY COTTON

**> 95%**

BACTERIAL FILTRATION EFFICIENCY (BFE) FOR PARTICLES > 3 MICRO METER



Eco Friendly Cotton

ADJUSTABLE EARLOOPS  
ONE SIZE FITS ALL

**MCMS 105 - REPS**

**SANTHOME PROTECT** Reusable Non-Medical 2 layer cotton face mask that is treated with Silvadur TM (A DuPont product) antibacterial agent. Comfortable daily use masks that protect you and do not harm the environment!

Print Technique : SC , HT

Preferred Print Location : Right Side

Max Print Size : 60 X 40 mm

Packing Details : 57 x 40 x 20 cm ; 600 pcs / carton ; gw / nw : 9.20 kg / carton

READY STOCK

## Safety( Isolation ) Goggles

Anti-splash, anti-fog and anti-dust



- > Anti-splash, anti-fog and anti-dust
- > 100% optically clear and 180 vision
- > Fully enclosed with 4 indirect valves
- > UV protected

**MCSG 974 - ROCHOR**

**Specifications:**

Lens: PC ; Frame : PVC; Weight: 48g/pc Optional class 1

**Certification:**

CE EN 166 IB 3, FDA. ISO9001

**Application:**

Hospitals, Clinics, Medical, Manufacturing, Construction, Mining, Oil and gas

## MASK EXTENSION STRAP

- > Application : Suitable for most of the ear-mounted masks to reduce the pressure and fatigue on the ears.
- > Design : There are 3 adjustable positions to clip the mask on the neck or the back of the head and free the ears from the pressure
- > Your Logo : What better way to be in the minds of your customers than an accessory having your logo and required to be used daily



MCMS 103 - Black    MCMS 104 - White





Giftology

ANTI-MICROBIAL TOUCHLESS KEYHOLDER



Foam with Sanitizer



MSKC 411 - SOROCA

Giftology Handy Keychain with naturally anti-bacterial brass (over 62% Copper) tip that provides protection against harmful micro-organisms. The tip can be used to push lift buttons or ATM buttons thereby avoiding direct contact. When the tip is not in use, the foam inside can be soaked with disinfectant to sanitize the tip. Packed in a box.

Print Technique : UV, SC, ENG

Preferred Print Location : Barrel

Max Print Size: 40 X 7 mm

Product Size : 10.2 X ø1 cm

ABS ( ANTI-MICROBIAL TREATED ) KEYRING TOOL

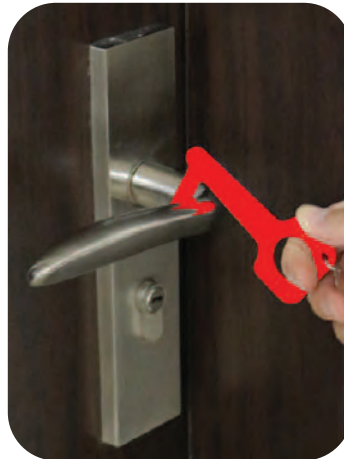

Red



Blue



Green



White



READY STOCK

MASTY

MTGL 843 - White MTGL 844 - Blue MTGL 845-Red MTGL 846-Green

Giftology A robust hygiene tool that allows the user to open doors and push buttons without any direct contact. Manufactured from strengthened materials for extra durability. This product contains antimicrobial technology that provides protection against the growth of harmful micro-organisms for the lifetime of the product. Supplied as a keychain.

Print Technique : UV, SC

Preferred Print Location : Front

Max Print Size : 30 X 6 mm

Product Size : 8 X 3.5 X 0.4 cm

Packing Details : 39.5 x 21.5 x 39 cm ; 1000 pcs / carton ; gw / nw : 10.3 kg / carton

HAND SANITIZERS 100% WHO-compliant



- > World Health Organization Compliant
- > Kills 99.9% germs
- > 70% ethanol
- > Made with moisturizing aloe-vera extracts

We support WHO's #SafeHands:



45ml



700ml pump

DermoViva USA Comes from a global \$1.2 billion consumer goods giant. DermoViva sanitizers are fully tested, guaranteed and certified products. DermoViva sanitizers do not create burning sensation & have a cooling effect on your palm.



- Made from MICROBAN Anti-Microbial treated high end material
- Two compartments for used and new masks
- L-shape zipper on top and bottom



TASAM 471 - NOGALES

READY STOCK



Open



Folded

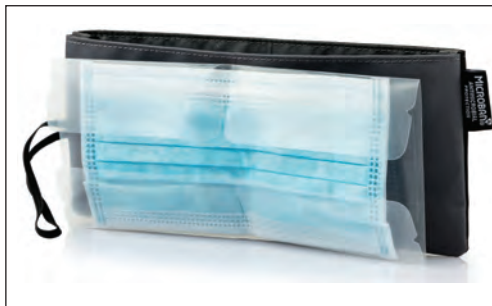

- Made from MICROBAN Anti-Microbial treated high end material
- Compartment for new masks
- PP film pocket for holding used mask
- Foldable and closed with elastic band
- Advantage : PP for easy cleaning. Extra pocket for alcohol wipe



TASAM 472 - CORDOBA



# ANTI-BACTERIAL PENS

Giftology



Blue Red Black Green



ANTI-BACTERIAL



BILLUND

WIMP 261 - Black WIMP 262 - Blue WIMP 263 - Red WIMP 264 - Green

Giftology Anti-Bacterial Metal Ballpoint pen with soft rubberized finish and matt gun metal trims. Especially designed for laser engraving, including a special coating for your logo. With 1200 m writing length and German Dokumental® Ink.

Print Technique : ENG, UV, SC Preferred Print Location : Barrel Max Print Size : 50 x 6 mm  
Product Size : 13.7 x ø1 cm Packing Details : 34 x 29 x 16cm ; 500pcs /carton ; gw/nw : 9.5/10.5kg /carton

- Tested for Anti-Bacterial effectiveness
- Soft Touch, Special mirror effect on engraving
- German Dokumental® Ink

READY STOCK



LEOVA

Blue White Grey

WIPP 818 - White WIPP 819 - Grey WIPP 820 - Blue

Giftology Pen is an object that every person keeps using and sharing. Sharing a pen means also transferring disease causing bacteria. Worried? Dont be! Because this pen is made from antibacterial agents produced with SIAA mark. With 99% Bacteriostatic Rate, these pens prevent growth and multiplication of bacteria on their surface.

Print Technique : SC, UV Preferred Print Location : Clip Max Print Size : 35 X 7 mm  
Product Size : 14 x ø1cm Packing Details : 54x 34x 18 cm ; 500 pcs /carton ; gw/nw : 5/4kg /carton

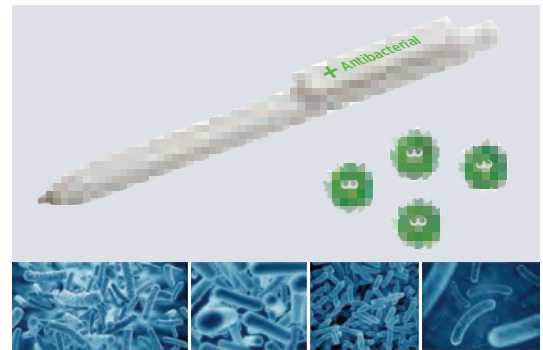

- Treated with Japanese Antibacterial agent produced with SIAA Member
- Great Branding Space on clip



DEPOK

WIPP 821 - White WIPP 822 - Blue WIPP 823 - Green

Giftology Carbon pattern click action ballpoint pen that is treated with Antibacterial Silver-Ion technology in accordance with ISO 22196. With 1200 meter writing length and German Dokumental® Ink.

Print Technique : UV, SC Preferred Print Location : Clip Max Print Size : 8 X 35 mm Product Size : 14 x ø1cm

- Treated for bacterial effectiveness
- 1200m writing length
- German Dokumental® Ink.



Green White Blue



# SANTHOME PROTECT

- > Cover made from recycled plastic (rPET) & treated with silver-ion Anti-Bacterial Technology
- > FSC Certified Paper
- > A5 Ruled Notebook, 160 Pages

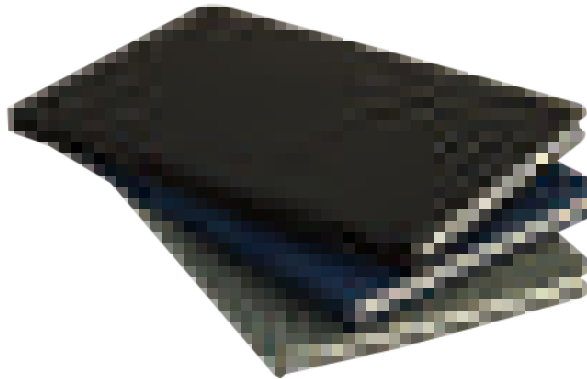

Black  
Navy Blue  
Grey

## BOOKMARK



**This Notebook Cares for You**  
Functional & Safe notebook that protects you against harmful microbes that may adhere to its surface. Kills 99.9% bacteria using Silver-Ion Technology.

**This Notebook Loves Trees**  
Paper used to make this notebook is FSC certified. FSC certified paper is paper that has been harvested in a socially and environmentally responsible manner. By using a FSC certified paper, you are helping to ensure our forests are alive for generations to come.

**This Notebook Cares for the Environment**  
The fabric cover of the notebook is made using recycled post-consumer plastic. The rPET material itself is sourced from a Global Recycled Standard (GRS) certified factory. GRS certificate communicates truth in materials and support for a circular economy that reduces waste by using it to make new products.

A notebook that is proudly made and a notebook you would proudly use!



## ORSHA

NBSN 341 - Black    NBSN 342 - Grey    NBSN 343 - Navy Blue

**SANTHOME PROTECT** A notebook that cares for you and for the environment. The cover of the notebook is made from recycled plastic (rPET) in a GRS Certified factory that complies with global recycling standards and is treated with anti-bacterial technology to provide protection against the growth of harmful bacteria. The paper used in this notebook is acid-free and FSC Certified. A5 notebook with 160 ruled pages each of 70 gsm

Print Technique : SC, HT

Preferred Print Location : Front

Max Print Size : 120 X 200 mm

Product Size : 14 X 21 X 1.4 cm

Packing Details : ( Black ) 36.5 X 33 X 24 cm ; (Black = 50 pcs) / carton ; (Grey& navy Blue = 59 pcs / carton gw / nw : 13.3 kg / carton

READY STOCK



Releases pressure off the ear when wearing mask !! Helps fight Covid-19



White



Black



Navy

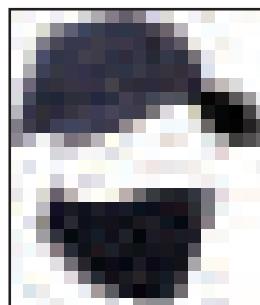

## KATHU

HWHL 187 - Black    HWHL 188 - White    HWHL 189 - Navy

**Hans Larsen** Heavy Brushed 6 Panel Classic cotton cap with button that allow you to put the mask straps around the buttons instead of your ears, a more comfortable way to wear face cover!

Print Technique : HT, SC, EMROIDERY

Preferred Print Location : Front

Max Print Size : 80 x 30 mm



THE IMPROVED BDNC POLO



THE  
ANTI-MICROBIAL  
DRYNCOOL  
EXECUTIVE  
POLO SHIRT



Navy



Red



White



Grey



Black

READY STOCK

Item : SECURE | Content : Dryncool fabric  
Measurement : Gulf | Sizes Available : S, M, L, XL, XXL, 3XL

SILAIDE 100 Anti Microbial Polo  
Premium executive wear  
No-fuss performance.  
Creaseless.  
Dryncool Moisture Management Technology



Print Technique :

- 1 Screen Printing
- 2 Heat Transfer
- 3 Embroidery

Preferred Print Location : Max Print Size:

Left Chest Area / Sleeve 80 x 50 mm

Care Instructions:



Packing:

53 x 33 x 45cm; 50 pcs/carton ; gw/nw: 15/16kg / carton  
\* Packing details may have ± 10% variation based on size breakup

\* Printing Limitations prevent exact fabric and color representation.  
The shades in the lots may differ due to lot-to-lot variations.  
The difference is no more than internationally accepted norms of the garments trade.

Constructed from intelligently designed antimicrobial fabric, this unique polo shirt SECURE's against viruses and bacteria that use fabric as a housing surface.  
Using MMS (Moisture Management System) Technology, this fabric pulls out the moisture away from the skin to the surface of the fabric for quick evaporation, which keeps your body dry and comfortable.  
\*SANTHOME & DUNIC are registered trademarks of SantHOME Middle East LLC. All other trademarks are the property of their respective owners.  
\*MMS (MMS) does not claim to prevent re-infection or treat any acute health issue.

مصنوع من القطن مضاد للبكتيريا وفيروسات معزز بتكنولوجيا نانو سيليكون مضاد للميكروبات التي تستخدم الأيونات المضادة للجراثيم والفيروسات التي تستخدم الأيونات المضادة للجراثيم والفيروسات.  
يستخدم تقنية MMS (نظام إدارة الرطوبة) ، يعمل القطن على سحب الرطوبة بعيداً عن الجلد إلى سطح القماش لتبخر بسرعة ، مما يحافظ على جفاف الجسم وراحة ومرتاحة.  
\*SANTHOME & DUNIC هي العلامات التجارية المسجلة لشركة SantHOME Middle East LLC. جميع العلامات التجارية الأخرى هي ملك لمالكها الأصلي.  
\*MMS (MMS) لا يدعي منع العدوى أو علاج أي حالة صحية حادة.

SECURE  
SANTHOME  
إضافة الفضة للحماية من الفيروسات المعدية  
Added Silver for Infectious Virus Protection  
ANTIVIRAL ANTIBACTERIAL

يتميز القطن المضاد للجراثيم والفيروسات في القماش المضاد.  
من دون القطن المضاد للجراثيم والفيروسات ، يتم القضاء على الجراثيم والفيروسات. يتم القضاء على الجراثيم والفيروسات.  
Without the presence of viruses, the bacteria, fungi, and small insects.

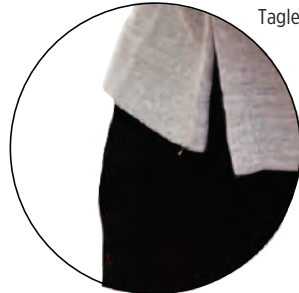

Side slits with bartack

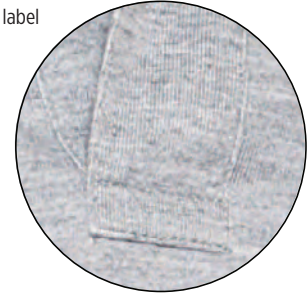

Double placket



HEIQ SWISS  
TECHNOLOGY

VIROBLOCK  
ANTIVIRAL  
PROTECTION

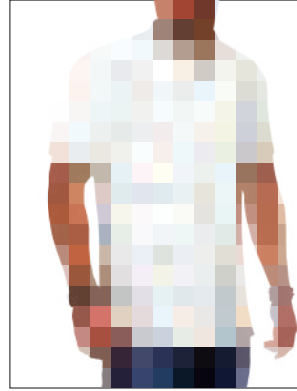

White

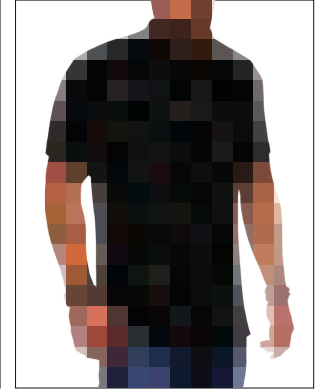

Black

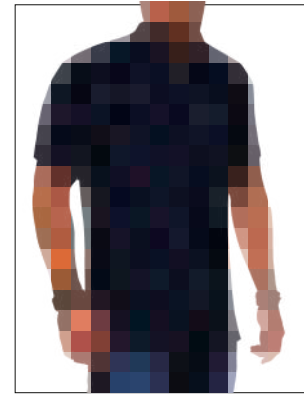

Navy

READY STOCK

Item: Shield | Content: 100% Polyester  
Measurement: Gulf | Sizes Available: S, M, L, XL, XXL, 3XL

VIROBLOCK ANTI VIRAL PROTECTION

Executive wear.  
Premium quality.  
No-fuss performance.  
Creaseless.

Print Technique:

- 1 Screen Printing
- 2 Heat Transfer
- 3 Embroidery

Preferred Print Location: Max Print Size:

Left Chest Area / Sleeve 80 x 50 mm

Care Instructions:



Packing:

51 x 36 x 41cm ; 50 pcs /carton ; gw/nw: 14/12kg / carton  
\* Packing details may have ± 10% variation based on size breakup

\* Printing Limitations prevent exact fabric and color representation.  
The shades in the lots may differ due to lot-to-lot variations.  
The difference is no more than internationally accepted norms of the garments trade.

مصنوع من قطن معزز للميكروبات مصمم بدقة، تم تصميمه جيدًا لمقاومة الفيروسات والبكتيريا التي تستخدم الألياف كسطح للتواجد. منتج HEIQ فيروبلوك متوافق مع كل من منتجات المبيدات الحيوية للإنتاج الأوروبي ، ومع القانون الاتحادي للمبيدات الحشرية ، ومبيدات الفطريات، ومبيدات الفواض في الولايات المتحدة.

“ستلوم درايف كول كين” علامة تجارية مسجلة لشركة ستانثوم هومز. المسود (حجم الجوز) المبرهن (البرهان). سيتم التعامل مع أي مطالبة لتقليد أو التفتيش بشكل قانوني.

هذا المنتج لا يضمن الوقاية من الأمراض المعدية أو تقليل أي مزايا من نقل العدوى المعدية.

Constructed from intelligently designed antimicrobial fabric, this wicking polo shirt SHIELDS against viruses and bacteria that use fabrics as hosting surfaces.

HEIQ Viroblock product is EU BPR and US FIFRA compliant.

\*Santhome & DrynCool are registered trademarks of Santhome Holdings Limited (SHL). Any infringement or duplication attempt will be dealt with legally.

\*This article does not claim to prevent infectious diseases, or make any public health claims.

تتميز بوناك الصلة (تحتفظ بجزء العنق) The silver ions are trapped in the textile matrix.

منع نمو البكتيريا والفيروسات؛ الفناء. تمنع نمو الفيروسات والبكتيريا. When bacteria or viruses are present, they are unable to replicate and therefore die.

لا يضمن عدم انتقال العدوى. بدون وجود المنتج، ستبقى البكتيريا والفيروسات تتكاثر وتنتشر. Without the presence of the product, bacteria and viruses will reproduce and spread further.

الدرع SHIELD من سانت-هومز SANTHOMES  
من سانت-هومز  
ميكروبيوك  
تحمية من الفيروسات  
VIROBLOCK  
ANTIVIRAL PROTECTION  
ANTIVIRAL ANTIBACTERIAL



Tagless label



# COVID-19 SAFETY KIT & ANTIMICROBIAL T-SHIRTS



Red

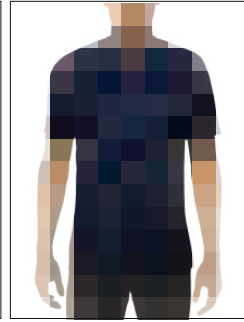

Ink Blue

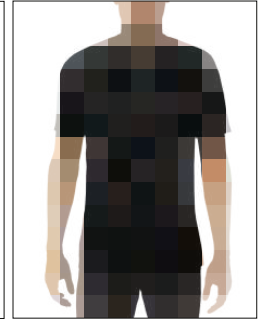

Black



Item: SALAMA | Content : 100% Polyester  
Measurement : Gulf | Sizes Available : S, M, L, XL, XXL, 3XL

### Print Technique :

- 1 Screen Printing
- 2 Heat Transfer
- 3 Embroidery

Preferred Print Location : Max Print Size:  
Left Chest Area / Sleeve 80 x 50 mm

### Packing:

 \* Packing details may have ± 10% variation based on size breakup

### Care Instructions:



\* Printing Limitations prevent exact fabric and color representation.  
The shades in the lots may differ due to lot-to-lot variations.  
The difference is no more than internationally accepted norms of the garments trade.

READY STOCK



## Brand Promotion Kit

Kit includes:

- 1 Salama AntiMicrobial T-Shirt for Men [1 pc]
- 2 Hans Larsen Heavy Brushed Cotton Cap with Mask Hook [1 pc]
- 3 Custom-made Non-Medical Face Mask [1 pc]
- 4 Carbon pattern click pen with Antibacterial silver ion technology [1 pc]
- 5 Neatly packed in a drawstring bag [1 pc]



HWSK 110 M



## Active Mind Kit

Kit includes:

- 1 45ml Hand sanitizer (DermoViva® brand by Dabur®) [1 pc]
- 2 Fruit infuser bottle - boost immunity with vitamins [1 pc]
- 3 Custom made Non-Medical Face Mask [1 pc]
- 4 Set of Skipping rope & Resistance Band
- 5 Neatly packed in a drawstring bag [1 pc]



HWSK 107 M

READY STOCK

## The New Normal Office Kits

Kit includes:

- 1 Santhome Secure **RESIL** AntiMicrobial Polo Shirt with DryNCoolTechnology [1 pc]
- 2 Santhome Protect UV-C Sterilization Box [1 pc]
- 3 45ml Hand sanitizer (DermoViva® brand by Dabur®) [1 pc]
- 4 Anti-Bacterial Pen [WIMP 261]
- 5 Notebook with FSC Paper and Anti-Bacterial RPET Cover [1 pc]
- 6 Neatly Packed in a gift box



HWSK 101 M



## VIP GIFTS & REWARDS



1

Kit includes:

- 1 Santhome Protect UV-C Sterilizing Box with Wireless charger **[1 pc]**
- 2 @Memorii True Wireless Earbuds with UV-C Disinfection **[1 pc]**
- 3 ABS Anti-Microbial Zero Contact Keychain **[1 pc]**
- 4 XD Design Protective Face Mask with 5 Filters and Pouch for 1000 hours usage **[1 pc]**
- 5 Neatly Packed in a gift box



2



3



4



5

HWSK 103 M

READY STOCK

## VIP GIFTS & REWARDS

Kit includes:

- 1 Santhome Protect Backpack with Anti-Bacterial Eco RPET fabric and UV-C Sterilization Pocket **[1 pc]**
- 2 Hans Larsen Double Walled Water Bottle with UV-C Sterilization **[1 pc]**
- 3 XD Design Protective Face Mask with 5 Filters and Pouch for 1000 hours usage **[1 pc]**



1



2



3

HWSK 104



## Inspiration Eco Set

Kit includes:

- 1 @Memorii Natural FSC Certified bamboo 3W speaker with **BIOMASTER** AntiMicrobial Technology [1 pc]
- 2 @Memorii Natural FSC Certified bamboo wireless 5000 mAh Powerbank with **BIOMASTER** AntiMicrobial Technology [1 pc]
- 3 @Memorii Natural FSC Certified bamboo 5W wireless charger with **BIOMASTER** AntiMicrobial Technology [1 pc]
- 4 A motivational letter from the CEO or President [1 pc]
- 5 Packed in an Eco-Friendly Jute Bag [1 pc]



HWSK 105

READY STOCK



## Executive Genuine Leather Sets

Kit includes:

- 1 Santhome Protect Genuine Leather Men's Wallet treated with **BIOMASTER** AntiMicrobial Technology [1 pc]
- 2 Santhome Protect Genuine Leather Men's Cardholder treated with **BIOMASTER** AntiMicrobial Technology [1 pc]
- 3 Giftology Anti-Bacterial Metal Pen with smooth rubber finish and special mirror engraving [1 pc]

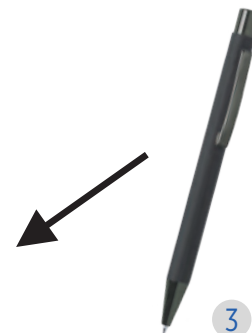
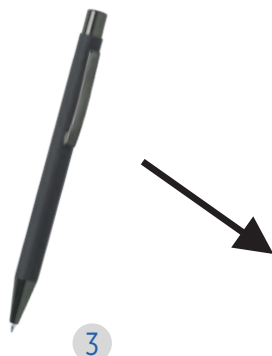

GSSN 497 - KLEVE  
Set of Anti-Microbial Leather Articles & Pen

Set Packaging

GSSN 498 - HAIGER  
Set of Anti-Microbial Leather Articles & Pen



# FIGHT-COVID BACKPACKS & POUCH

Giftology



Blue



Black



Grey



Exterior Fabric is Anti-Bacterial



MALACCA

BPGL 671 - Black BPGL 672 - Grey BPGL 673 - Blue

Giftology Everyday backpack with Antibacterial exterior fabric to ensure that your backpack is free from harmful disease - causing bacteria. Commute and travel with this backpack without worrying about accumulating bacteria on your backpack during multiple contact with foreign surfaces. This backpack features a 15" laptop compartment, a USB external charging port, easy to access 2 front compartments and a water bottle pocket on the outside.

Print Technique : SC

Preferred Print Location : Front

Max Print Size : 200 X 150 mm

Product size : 42 X 30 X 10 cm

Packing Details : 60 x 45 x 42 cm ; 25 pcs /carton ; gw/nw: 13/12 kg/ carton

READY STOCK

SANTHOME  
PROTECT



UV-C Kills 99.9% bacteria

2 different zippered compartments, for UV-C & for holding travel & daily accessories

Sterilise on - the - go

Use your own powerbank / power source or check with us for our range of powerbanks ( Pages 94 to 100 )

Non - Toxic; Without Mercury



ITSN 104 - HABRY

SANTHOME PROTECT Everyday use pouch that keeps your daily articles SAFE and HYGIENIC. This pouch has a special compartment with UV-C light that kills 99.9% bacteria on the item kept in the compartment. This UV-C compartment can help you with sterilizing your currency, passport, boarding pass, phone etc that are generally prone to multiple contact with bacterial surfaces by just connecting a cable provided on the back pocket to a power source such as laptop or powerbank. Another zipper compartment features- a zipper pocket for keys, currency, coins etc., pocket to hold multiple passports and has space for your everyday electronic accessories. Packed in a Santhome gift box.

Print Technique : SC, HT

Preferred Print Location : Front Bottom

Max Print Size : 75 X 70 mm

Product Size : 21.5 X 13 X 4.5 cm

Packing Details : 45.7x 31.5 x 48.4 cm ; 28 pcs / carton ; gw / nw : 13.2/14.2 kg / carton



THIS BAG CARES FOR BOTH THE ENVIRONMENT AND YOUR HYGIENE

### Features

- RPET Antimicrobial External fabric
- UV-C Sterilization pocket on the front
- Fits laptop upto 15.6"
- Integrated External USB Output
- Padded interior laptop, tablet and accessory pockets
- Back panel with elastic strap to slip over trolley handles

SANTHOME



External Fabric Created From 100% Post-Consumer Recycled Plastic



### HOW WE MAKE IT:

- COLLECT DISCARDED PET BOTTLES
- CUT INTO CHIPS
- MELTED INTO A FIBER
- SPUN INTO A YARN
- YARN USED TO CREATE OUR BAGS



READY STOCK

UV-C Sterilizing Pocket

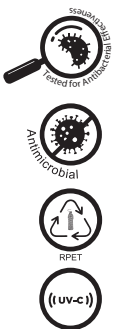

- External Fabric made from Recycled Post-consumer plastic
- UV-C Sterilizing pocket to Sanitize small articles as phone, wallet, currency etc On-the-go
- Outside material treated with Anti-Bacterial Technology
- Large capacity backpack with practical pockets

### BPSN 795 - CASTILE

SANTHOME PROTECT Make the daily commute a little bit easier and a lot more safe with this laptop backpack with UV Sterilizing pocket. The bag is made from durable Anti-Bacterial 1680D RPET polyester fabric with rich PU details and features a pocket on the front in which you put any article for 5 min and get it out disinfected with UV-C technology. The built-in USB A cable needs to be connected to the powerbank (not included) in order to power the UV-C system. In addition to the roomy main compartment, this backpack features a padded 15.6" laptop pocket and an additional zipper pocket to hold your other daily essentials. Other features of this backpack include an USB output, and a side water bottle pocket.

Print Technique : SC

Product size : 47 x 14 x 29 cm

Preferred Print Location : Front Top

Max Print Size : 100 x 40 mm

Packing Details : 65 x 52 x 35 cm ; 10 pcs /carton ; gw/nw: 9.5 kg / carton

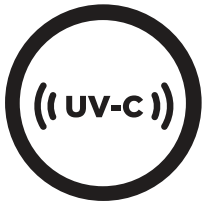

### WHAT IS UVC GERMICIDAL LIGHT?

UVC wavelengths are between 250 and 280 nanometers, making them germicidal – meaning they are capable of inactivating microorganisms, such as bacteria, viruses and protozoa.



### HOW DOES UVC LIGHT WORK ?

The high energy from short wavelength UVC light damages the DNA of bacteria and viruses thereby preventing replication and ability to infect.



### OUR UVC DISINFECTION PRODUCT RANGE

All our UVC products are mercury free and hence environmental friendly. Our products have been tested to be effective in disinfecting 99.9% bacteria such as E. Coli and Staphylococcus.

READY STOCK



UV-C Light Source

#### DWHL 254 - MONZA

Hans Larsen™ 500 ml Double Walled Vacuum water bottle with UV-C steriliser that kills up to 99.9% of the bacteria in the drink inside the bottle. You can choose to do a quick clean in 3 min sterilization or a complete clean 5 minute sterilization. For protection, the UV-C light automatically switches off once the lid leaves the bottle. With a 400 mAh battery, the UV-C light can work for 2.5 hours or 50 regular sterilizations. The bottle keeps a drink hot for 12 hours and cold 24 hours.

Print Technique : UV, SC, ENG Preferred Print Location : Front Max Print Size : (Flat)35 X 100 mm; (Round) 100 X 200 mm  
Product Size: 24.4 x ø6.4cm





READY STOCK

- > Kills upto 99.9% Bacteria
- > 90 Seconds Quick Clean or 5 Minutes Complete Clean
- > Built-in 5W Wireless Charger



ITSN 101 - TIGRE

SANTHOME MULTIFUNCTION UV-C STERILISER THAT KILLS UP TO 99.9% OF THE BACTERIA PLACED INSIDE THE DEVICE. SIMPLY PLACE OBJECTS LIKE EARBUDS, JEWELLERY, WATCHES AND FACEMASK INSIDE THE STERILISER TO STERILISE THEM USING UV-C TECHNOLOGY. YOU CAN CHOOSE TO DO A QUICK CLEAN IN 90 SECONDS OR A COMPLETE CLEAN IN 5 MINUTES. THE 2 UV-C LED LIGHT INSIDE IS NON-TOXIC AND MADE WITHOUT MERCURY UNLIKE MANY UNSAFE UV LAMPS IN THE MARKET. THE DESIGN WILL ALSO ENSURE THAT THE UV-C LED LIGHT WILL SWITCH OFF AUTOMATICALLY WHEN THE BOX IS OPENED SO THE USER WILL NOT BE EXPOSED TO THE UV-C LIGHT. THE LIGHTS HAVE A LIFECYCLE OF 10,000 HOURS. ON TOP OF THE STERILISER IS A 5W WIRELESS CHARGER TO CHARGE YOUR MOBILE DEVICE. INCLUDING 100 CM PVC FREE TPE TYPE C CABLE. INPUT: 5V/1.5A; OUTPUT: 5/1A - 5W.

Print Technique : UV, SC Preferred Print Location : Top Left Max Print Size : 60 X60 mm  
Product Size : 4.3 x 12.6 x 20.4 cm Packing Details : 57.5 x 36.5 x 31 cm ; 28 pcs / carton ; gw / nw : 11/11.8kg / carton



READY STOCK

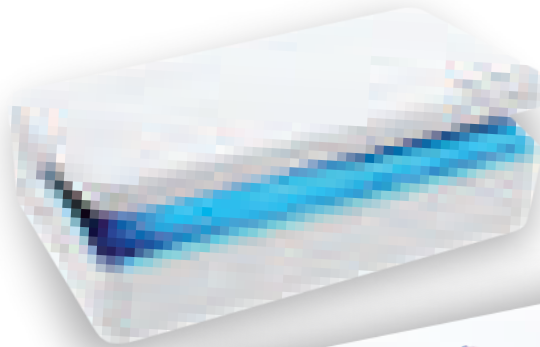

- > Kills upto 99.9% Bacteria
- > 90 Seconds Quick Clean or 5 Minutes Complete Clean



**ITSN 103 - HORKI**

SANTHOME  
PROTECT

UV-C steriliser that kills up to 99.9% of the bacteria placed inside the device. Simply place objects like earbuds, jewellery, watches and facemask inside the steriliser to sterilise them using UV-C technology. You can choose to do a quick clean in 90 seconds or a complete clean in 5 minutes. The 2 UV-C LED light inside is non-toxic and made without mercury unlike many unsafe UV lamps in the market. The design will also ensure that the UV-C led light will switch off automatically when the box is opened so the user will not be exposed to the UV-C light. The lights have a lifecycle of 10,000 hours.

Print Technique : UV, SC

Preferred Print Location : Top

Max Print Size : 60 x 40 mm

Product Size : 4.3 x 12.6 x 20.4 cm



READY STOCK



ITBH 101 - SKOLE

@MEMORii Let the music flow with these true wireless earbuds in a charging case. Equipped with UV sterilization, this TWS is cleaner and safer to use. Simply put the earbuds in the charging case and the UV will automatically sterilize the bacteria for 90 seconds. While the case is opened in the progress of sanitizing, the process will be stopped immediately to protect the user from harmful UV-C light. The earbuds have a 35 mAh battery and can be re-charged in the 400 mAh charging case. With auto pairing function so easy to pair to your mobile device. Playing time on medium volume about 2 hours. With BT 5.0 for optimal connection. Operating distance up to 10 metres. With pick up and mic.

Print Technique : SC

Preferred Print Location : Front Pocket

Max Print Size : 75 X 70 mm

Product Size : 5.25 X 4.9 X 2.9 cm



# TRUE WIRELESS STEREO EARBUDS (TWS)



### Features:

- RoHS** Confirms to Hazardous substances directive 2011/65/EC
- Confirms to Alkaline batteries safety directive EN 62133
- MSDS** Material safety data sheet available
- Confirms to PAHS content in Reach & ZEK 01-4-08
- SCCP** Free from short and medium-chain chlorinated paraffin

- Elegant designer TWS
- CE-ROHS, MSDS, SCCP free
- Natural bamboo
- up to 3 hours play time including 3 size eartips

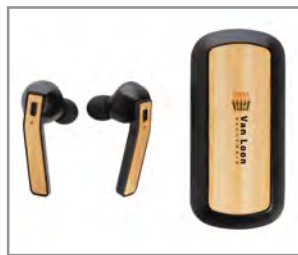

ITXD 742 - BEBRA

**XDDDESIGN** Let the music flow with these true wireless earbuds in charging case. The bamboo earbuds have a 35 mAh battery and can be re-charged in the 500 mAh charging case within 1 hour. With auto pairing function so easy to pair to your mobile device. Playing time on medium volume about 3 hours. With BT 5.0 for optimal connection. Operating distance up to 10 metres. With pick up and mic. Including 3 size silicone ear tips. Bamboo and ABS material.

Print Technique : UV, ENG  
Product Size : 2.9 x 3.8 x 8.1 cm

Preferred Print Location : Top of Box    Max Print Size : 40 X 10 mm  
Packing Details : 26.5 X 33.5 X 58.5 cm; 100 pcs / carton ; gw / nw : 8.8 kg / carton

READY STOCK



CERTIFIED BY INTERTEK  
Intertek - D26928-R2

### DEVICE LAYOUT

1. Charging pod left earphone slot
2. Charging status indicator light
3. Charging pod right earphone slot
4. Left earphone indicator
5. Touch button position of the right channel
6. Charging port of the charging case



- Uses Recycled Claim Standard (RSC) plastic, certified by Intertek
- Bluetooth TWS earbuds with 3 hour playtime + 22 hours backup playtime

TWS made from recycled plastic  
ITBH 852 - ALAVUS

**MEMORI** This highly useful wireless earbud is a proud possession - made from RSC-Certified recycled materials so that you use it guilt-free. The earbuds have a 40mAh built-in battery to provide 3 hours continuous playtime + 300mAh backup power in the case, with charging time less than an 1 hour. Uses latest Bluetooth 5.0 for an effective operating range of 10 meters.

Print Technique : UV  
Product Size : 6.2 X 4 x 2.8 cm

Preferred Print Location : Top    Max Print Size : 20 X 30 mm  
Packing Details : 34 x 20.5 x 24 cm ; 120 pcs / carton ; gw / nw : 7/8 kg / carton



PUCON  
WNAT 814 - Blue WNAT 816 - Aqua

Giftology Pucun is a smart activity tracker that keeps track of your daily activities & helps you stay fit & healthy. It counts your steps, calories and monitors your sleep. Functions also include Incoming call reminder, selfie remote and music play control. The band is lightweight and very comfortable to wear day and night. It records & presents your data effectively to help you achieve your fitness goals. Packed in a gift box.

Print Technique : UV, ENG Preferred Print Location : Strap Max Print Size : 25 x 8 mm  
Product Size : 25 x 2.3 x 1.3 cm Packing Details : 46 x 28.3 x 24 cm; 99 pcs/carton; gw/nw: 5.3 kg/carton

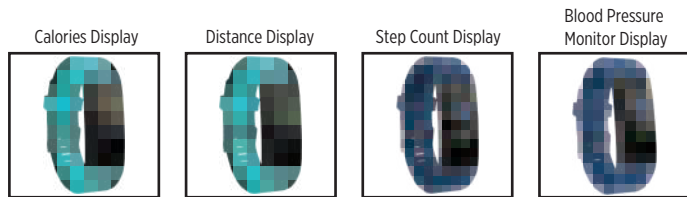

**Hardware Features :**

- Band : Material : Silicon  
Length: 255mm
- Screen : Size: 0.96inch  
Type: TFT  
Resolution: 80\*160
- Battery : Battery Capacity: 90mAh  
Standby Time: 10days  
Normal Use Time: 7days
- Weight : 82g
- Operating Mode : Single Touch
- Compatible OS : Android 4.3, IOS 8.0 or above

**Other Functions :**

- Do not disturb mode
- Information reminder
- Clock display
- Instagram Notification
- Facebook Notification
- Call Notification
- Twitter Notification



Scan Below QR code to watch product video



READY STOCK

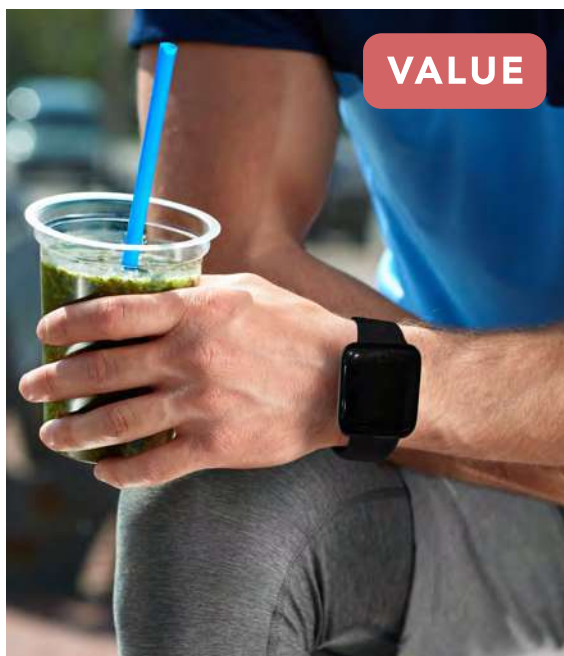

WANAKA  
WNAT 301 - Black WNAT 302 - Navy Blue WNAT 303 - Red

Giftology Wanaka is a activity tracker watch with 1.3" single point touch screen. Features include: Step count, calories, distance, alarm clock, sleep monitor, anti lost, remote photo, blood pressure monitor, oxygen monitor, notifications: SMS, Facebook, Skype, WhatsApp, Twitter etc. Compatible with Android 4.3 and IOS 8.0 and above. IPX7 waterproof. Battery time up to 80 hours on one charge depending on usage.

Print Technique : ENG, UV Preferred Print Location : Strap Max Print Size : 40x10 mm  
Product Size : 25 x 3.8 x 1.1 cm Packing Details : 45 X 27 X 33 cm; 100 pcs/carton; gw/nw: 5 kg/carton



- Call alerts
- Wakeup clock  
Set the time & it will wake you up
- Steps  
Records the number of steps taken everyday
- Distance  
Calculates the distance you walk everyday
- Sleep monitor  
Monitor your deep/light sleep
- Calories  
Displays Calories Burned. Keep a track of your fitness!
- SMS/SMS alert

- > Color Screen With Single Touch Control
- > Blood Pressure & Oxygen Monitor
- > IPX7 Waterproof
- > Value Deal !!



# ACTIVITY TRACKER & MAGNETIC WIRELESS CHARGER

**LUXURY**



- > Fitness Smart Watch With-Heart Rate Monitor
- > Full Touch Screen-Nordic Chipset
- > 50 metre waterproof
- > Good for swimming and snorkelling
- > 5D Corning Gorilla Glass



### Function Highlights

- |                                |                       |                      |                                   |                    |                       |
|--------------------------------|-----------------------|----------------------|-----------------------------------|--------------------|-----------------------|
| Female health care             | Heart rate monitoring | Sleep monitoring     | Music control                     | Multi-motion modes | Message reminder      |
| Calorie consumption monitoring | Long sitting reminder | Call reminder        | Target completion reminder        | Alarm clock        | Camera remote-control |
| Brightness self-regulation     | Seeking mobile phone  | Respiratory training | Step-counting monitoring function |                    |                       |

**WNAT 817** - Vaughan  
 Print Technique : Eng  
 Preferred Print Location : Strap  
 Max Print Size : 10 x 10 mm  
 Product Size : 25 x 3.5 x 0.9 cm  
 Packing Details : 57.5 X 31.5 X 30.5 cms;  
 100 pcs / carton; gw / nw : 7.4/8.1 kg / carton

**READY STOCK**



## MAGNETIC is the new trend!

Snap on this magnetic wireless charger to the back of your iPhone 12 to charge your device. The magnets are perfectly aligned for the correct charging position. This wireless charger is also compatible with all Qi devices (iPhone 8 and up and latest android devices). This ensures this can be used as a regular wireless charger for other phones as well.



- > 15W fast charging for Iphone 12
- > 15W means 3 times faster wireless charging
- > Bamboo - eco friendly
- > MAG/SAFE compatible



**ITWC 156** - DOMITZ

@MEMORii Domitz is a Magnetic wireless charger with a bamboo casing - 15W wireless capacity for super fast charging.

Print Technique : SC, UV, ENG  
 Product Size : 6 X 6 X 0.8 cm

Preferred Print Location : Top Max Print Size : 40 X 40 mm  
 Packing Details : 43.5 x 42.5 x 25.5 cm ; 200 pcs / carton ; gw / nw : 12.5/13.5 kgs / carton



- > Carry to Meetings, a Travel companion & a Desk pad modern accessory
- > Laptop & Mobile stand with Wireless Charger, with Notepads for quick notes
- > Mouse pad is an additional functionality
- > Elastic Band for secure closure

READY STOCK



**ITFO 291 - KAHLA**

SANTHOME A modern Folder / Portfolio that works superbly as a desk pad, workstation, wireless charger & mouse pad.

Print Technique : EMB, ENG, UV, SC, FO  
Product Size : 29 X 21 X 2.5 cm

Preferred Print Location : Front

Max Print Size : 170 X 260 mm

Packing Details : 53.5 x 46 x 33.3 cm ; 15 pcs /carton ; gw/nw: 13.9 kg / carton



# WIRELESS SPEAKER



READY STOCK



Scan Below QR code to watch product video



- > Powerful Sound Wireless Speaker with 10 hours playtime
- > 5W Wireless Charger
- > Digital Alarm Clock
- > 4000 mAh Built-in powerbank

### ITSP 204 - SOMOTO

Somoto is a multifunctional portable wireless charger with alarm clock, a powerful 5 W wireless speaker and a 4000 mAh built in powerbank. The speaker uses wireless BT 5.0 for smooth connection and has an operating distance up to 10 metres. With hands-free function and pick up. The 4.000 mAh battery allows you to play music for up to 10 hours or charge your mobile phone twice (depending on the size of your phone's battery) Input: 5V/2A. Output: 5V/1A. Wireless output: 5V/1A 5W.

Print Technique : SC, UV Preferred Print Location : Top Max Print Size : 30 x 50 mm  
Product Size : 10.6 x 8.5 x 8.7 cm Packing Details : 21.5 x 21.5 x 24 cm; 8 pcs/carton; gw/nw: 4.5/5.0kg/carton





READY STOCK



- > Eco Friendly RPET Material
- > 5 Watts Wireless Charger
- > With Mouse pad, Desk Stand
- > Elegant Fabric gives a Rich appearance
- > Folds completely, hence a Travel-friendly accessory

**ITWC 153 - GORI**

@MEMORI Stay organized in your office or while traveling with our portable desk accessory, which can be packed flat. It can also unfold for use and maintain its position with a magnet. When in use, it can hold mobile phones, pens, serve as a mouse pad and a wireless charger - all in one. Great desk gift with an elegant linen finish and made sustainably with recycled rPET.

Print Technique : SC, UV, ENG Preferred Print Location : Front & Back  
 Max Print Size : (Front) 70 x 30 mm (Back) 260 x 30 mm  
 Product Size : 22 X 28 cm  
 Packing Details : 48.5 X 33 X 33 cm ; 30 pcs / carton ; gw / nw : 11/10 kgs/ carton



- > Eco Friendly RPET Material
- > 10 Watts Wireless Charger
- > With Mouse pad, Desk Stand
- > Elegant Fabric gives a Rich appearance
- > Folds completely, hence a Travel-friendly accessory

**ITWC 154 - VANI**

@MEMORI Stay organized in your office or while traveling with our portable desk accessory, which can be packed flat. It can also unfold for use and maintain its position with a magnet. When in use, it can hold mobile phones, pens, serve as a mouse pad and a wireless charger - all in one. Great desk gift with an elegant linen finish and made sustainably with recycled rPET.

Print Technique : SC, UV, ENG Preferred Print Location : Front & Back  
 Max Print Size : (Front) 70 x 30 mm (Back) 260 x 30 mm  
 Product Size : 22 X 28 cm  
 Packing Details : 48.5 X 33 X 33 cm ; 30 pcs / carton ; gw / nw : 11/10 kgs/ carton



RECYCLED ABS AND RPET TRUE WIRELESS CHARGER & EARBUDS (TWS)



CERTIFIED BY INTERTEK  
Intertek - D26928-R2



ITWC 155 - HANKO

@MEMORI Wireless charger from recycled material. Micro USB input: DC5V.2A (max) W47-R Wireless charger Wireless output: 5W.

Print Technique : UV, SC, ENG

Preferred Print Location : Front

Max Print Size : 35 X 25 mm

Product Siz: ø 10 X 0.7 cm



READY STOCK



- > Treated with Biomaster Antimicrobial Technology from UK
- > FSC Certified Bamboo
- > Fashion 5W Mini Wireless Charger

ITWC 241 - POLIS

@MEMORI Charge your mobile devices without connecting a cable with this ECO 5W wireless charger made from FSC Certified Bamboo and ABS with soft touch finish. Just place your mobile phone on the pad and wait for the charging notification to appear. This product contains Biomaster antimicrobial technology that provides protection against the growth of harmful micro-organisms for the lifetime of the product. Input: 5V/2A. Wireless output: 5V/1A. Including micro USB cable.

Print Technique : UV, SC, ENG

Preferred Print Location : Front

Max Print Size : 35 X 25 mm

Product Size : 6 X 6 X 0.9 cm

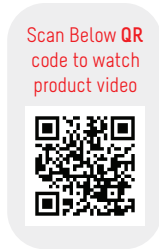

EFEN 220 - Couvin

eco-neutral Cardboard cube with lid. Folds out to reveal small sticky notes in 5 different colours (25 sheets per color), included 30 paper clips, 4 pen holder slots, business card slots, a mobile stand and most importantly, a wireless charger. The Wireless charger has a 5W output. A perfect tech desk accessory for the modern desk!!

Print Technique : UV, SC

Preferred Print Location : Front Max Print Size : 90 x 90 mm44 x 17mm

Product Size : 10.5 x 10 x 10.5 cm

Packing Details : 44.5 X 27 X 42.5 cm; 75 pcs/carton; gw/nw: 15 kg/carton



## AN INTELLIGENT MUG WARMER & PHONE WIRELESS CHARGER use at home or in the office.



READY STOCK



Reinforced Porcelain



Smart Safety Feature - **Foreign Object Detection**  
Wireless charger and heating coil remain shut when a foreign object is detected

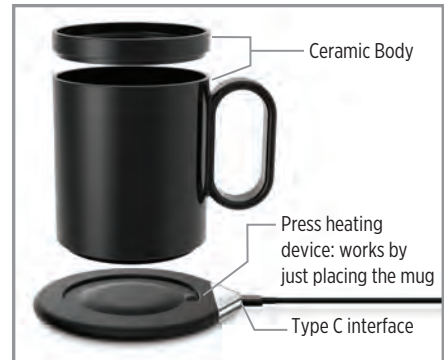

- > Material is safe-to-touch even with ON
- > Continuous 8 hours working
- > Mug 350ml capacity
- > Constant temperature 55°C
- > Supports Qi standard wireless charging of phones incl. Apple & Android upto 10W.



Intelligent Foreign object Recognition identifies metal items that are accidentally place in panel



Wireless / Heating Coaster is waterproof

CRIVITS  
ITHL 534 - WIRELESS CHARGER & CUP WARMER SET

Hans Larsen™ Works with compatible cup / mug only as effective contact points work in tandem with each other. This intelligent base recognises metal foreign objects placed accidentally, and stays shut. Panel is waterproof & safe to touch even when switched on. The radio bottom cooling sheet dissipates heat at high temperature & accumulates heat when temperature is low. Mode of heating - wireless induction. Wireless Coaster can be used as a normal Wireless Charger with mobile phones too!

Print Technique : SC, UV      Print Location : Plate & Front of Mug      Max Print Size : (Plate) 10 x 10 mm  
Product Size : ø8.5 x 10.5 cm      Packing Details : 59 X 41 X 35 cm; 24 pcs/carton; gw/nw: 19.5/18.5 kgs /carton



# WIRELESS CHARGERS

Place your phone as per your convenient angle of view



**VALUE**

Scan Below QR code to watch product video

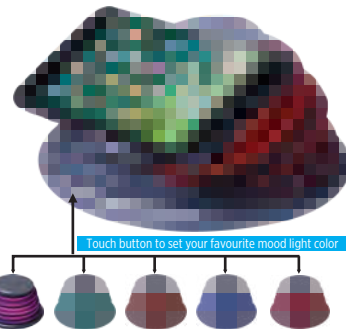

- > 10 WATT Fast Wireless Charger
- > Collapsible Silicon Design To Place Your Phone At Your Angle Of Convenience

- > Perfect For Home And Office Use
- > Six Different Mood Light Colors



ITWC 101 - SORRENTO

@MEMORII Sorrento is a 10 Watt fast charge desk wireless charger with color changing moodlight. The collapsible silicon design allows for the phone to be positioned and charged at various angles depending on the use. The single touch button on the front allows for 6 different colors to be displayed with each touch. This useful device is a perfect eye catcher for your office or home! Compatible with all Qi enabled devices like Android latest generation, iPhone 8, 8S and X. Input: 5V/2A. Wireless Output: Output: 9V/1.1 10W.

Print Technique : UV

Preferred Print Location : Front

Max Print Size : 40 x 50 mm

Product Size : 8.5 x ø14.5 cm

Packing Details : 32 X 30 X 32 cm ; 40 pcs / carton ; gw / nw : 9.4 kg / carton

READY STOCK



**VALUE**

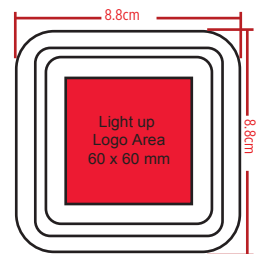

- > 5 WATT Wireless Charger
- > Light-Up Logo When Engraved

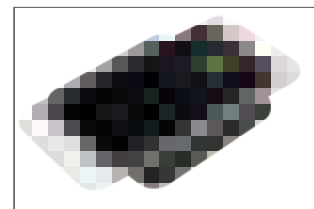

ITWC 104 - KOTOR

Giftology Charge your mobile devices without connecting a cable. Just place your mobile phone on the wireless charging pad and wait for the charging notification to appear. The charging pad allows you to decorate your logo on the pad; once connected the logo will light up giving your brand an optimal exposure. Compatible with all Qi enabled devices like Android latest generation, iPhone 8, 8S and X. Input: 5V/1.5A. Wireless Output: 5W

Print Technique : UV, SC, ENG

Preferred Print Location : Front

Max Print Size : Light-up Logo 60 x 60 mm

Product Size : 8.8 x 8.8 x 1.3 cm

Packing Details : 51.5 X 21.5 X 26 cm ; 100 pcs/carton ; gw/nw : 10.6 kg/carton

@MEMORII



- > 5W Wireless Charger
- > Large Light-Up Logo Area For Optimal Brand Exposure
- > 3 USB Outputs For Wired Charging
- > Perfect Desk Accessory



ITWC 205 - CERGY

@MEMORII Cergy is the perfect item for on your desk or table! The light up logo area on the front allows for a large logo space with great visibility making it a perfect gift. This trendy desk organizer allows you to keep your desk tidy and charge your phone without any wires. Including 100 cm micro USB cable to connect the charger to a power source. 5W wireless charging. Input DC 5V/ 1.5A. Output: 5V/800mA.

Print Technique : SC, ENG

Preferred Print Location : Front Max Print Size : 90 x 63 mm ( Light-Up logo)

Product Size : 25 x 10 x 1 cm

Packing Details : 29 x 26 x 22.5 cm ; 26 pcs / carton ; gw / nw : 4.9 kg / carton



COMMUNICATE YOUR BRAND MESSAGE EFFECTIVELY ON TEMPERED GLASS SURFACE

- > Excellent Branding Space On Scratch Proof Tempered Glass Surface
- > Wireless Output: 5W
- > Smooth Rubberised Surface



ITWC 204 - RENNES

@MEMORii Rennes is a 5W Round Wireless Charger with a front Scratch-Proof Tempered Glass surface that can be branded edge to edge for optimal brand exposure. The back of the wireless charger has a smooth rubberized finish for comfortable user experience. Micro USB Input- 5V/1A, Wireless Output: 5W.  
 Print Technique : UV, SC Preferred Print Location : Front Max Print Size : ø65 mm  
 Product Size : ø7.5 cm Packing Details : 21 x 21 x 25 cm ; 66 pcs /carton ; gw/nw: 4.9 kg / carton



CREATIVE  
QUALITY



READY STOCK

ITXD 817- ENCORE WIRELESS CHARGER

XD XCLUSIVE' State of the art design wireless charger with transparent designs to expose the A+ grade quality components, high quality charging coil and blue LED charging light. The charging pad supports 10W fast and safe charging to charge your phone twice as fast as most other wireless chargers in the market. Input: 5V/2A Wireless Output: 9V/1.110W. Including 150cm USB to Type C cable for fast charging.  
 Print Technique: SC, UV Preferred Print Location: Front, Down Max Print Size : 30 X 15 mm  
 Product Size : 1.1 x ø10 cm Packing Details : 16.3 x 26 x 63.5 cm ; 50 pcs /carton ; gw/nw: 6.5 kg / carton

VALUE

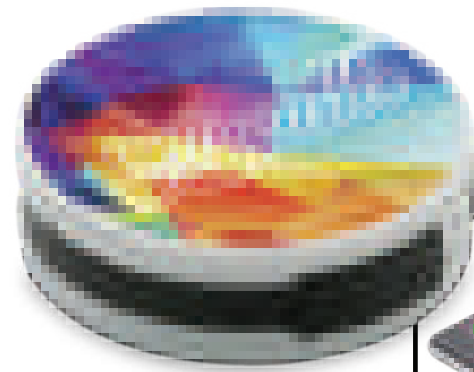

- > 5 WATT Wireless Charger With Integrated Cable
- > Hub With 2 USB Ports
- > Excellent Edge-To-Edge Branding Space



ITWC 105 - YSTAD

Giftology 5 WATT wireless charger with 2 output USB hub for wired charging. Integrated USB cable allows for the wireless charger to be connected to power source Input: 5V/2A. Wireless Output: 5V/1A, 5W.  
 Print Technique : UV, SC Print Location : Front Max Print Size : ø60 mm  
 Product Size : 6 x 6 x 1.6 cm Packing Details : 37.5 X 17 X 29 cm; 100 pcs/carton; gw/nw: 6.15 kg/carton



# WIRELESS CHARGERS

VALUE



- > 5 WATT Wireless Charger
- > Built-In Removable 3 in 1 Micro USB+ Type-C+Lightning Cable
- > Slim & Opens Up To Form A Stand
- > Excellent Branding Space !!

ITWC 206 - BEROVO

Giftology Berovo is a 5W wireless charger stand with built in 3 in 1 Type-C + Apple Lightning + Micro USB cable. Now you can watch your movies and charge your phone at the same time with the newest in charging technology, wireless charging. Packed in a gift box. Input-5V/1A, Output (Wired)- 5V/2A and Wireless - 5V/1A (5 Watt).

Print Technique : UV, SC Preferred Print Location : Front Max Print Size : 100 X 60 mm  
Product Size : 10 x 6 x 0.8 cm

VALUE

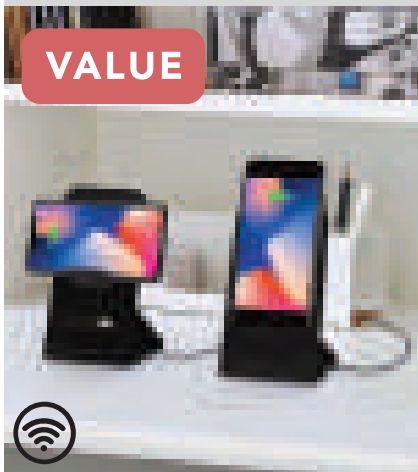

Scan Below QR code to watch product video



- > 5 WATT Wireless Charger
- > Supports Latest Android And Ios Devices (Iphone 8 And Up)
- > Charge Your Phone Either In The Landscape (Horizontal) Position Or Portrait (Vertical) Position
- > Foldable Flat For Easy Carry

ITWC 151 - RABAT

Giftology Rabat is a 5 Watt Wireless Charger that is perfect for your desk. The integrated cable allows for the wireless charger to be used anywhere. You can place your phone either in the Landscape (Horizontal) Position or Portrait (Vertical) Position on this charger and within seconds the charging notification will appear. Compatible with all Qi enabled devices like Android latest generation, iPhone 8, 8S and X.

Print Technique : UV, EMB, SC Preferred Print Location : Front Max Print Size : 20 x 50 mm  
Product Size : 32.5 x 9 x 0.7 cm Packing Details : 43 X 49.5 X 15 cm; 60 pcs/carton; gw/nw: 10.52 kg/carton

READY STOCK

Back Part



Scan Below QR code to watch product video



Heat Dissipation Design

Anti-Slip Feet



Adjustable holder to fit a phone big or small !!

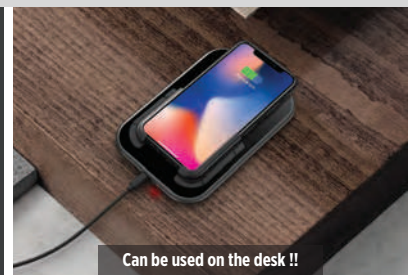

Can be used on the desk !!

- > 10WATT Fast Wireless Charger
- > Adjustable Holders To Fit Most Phones
- > Can Be Secured To The Wall Or Placed On The Table
- > Airvents Prevent The Charger From Getting Heated

ITWC 152 - MEKNES

Giftology Meknes is a unique wireless charger that can be used on the desk or can be mounted to the wall. It has a fast wireless charging output of 10 Watts. Also, the adjustable side holders allow for different sizes of phones to be accommodated. Air holes in the side keep the charger cool while charging. Rubber strips ensure stability. Compatible with all Qi enabled devices like Android latest generation, iPhone 8, 8S and X.

Print Technique : UV, SC Preferred Print Location : Front Max Print Size : 120 X 80 mm  
Product Size : 15.2 x 10.2 x 2.3 cm Packing Details : 42x 56 x 19.5 cm; 60 pcs/carton; gw/nw: 12.3 kg/carton



Treated with Biomaster Antimicrobial Technology from UK

FSC Certified Bamboo

Fashion 5000 mAh Wireless Powerbank



USB Output 1    Type-C Input    USB Output 2

Treated with Biomaster Antimicrobial Technology from UK

FSC Certified Bamboo

Fashion 8000 mAh Wireless Powerbank

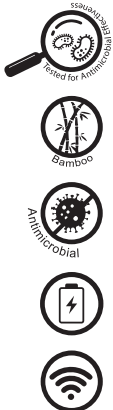
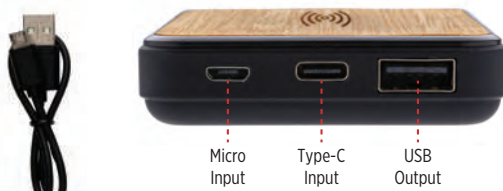

ITPB 836 - TUZLA

©MEMORI 5000 mAh heavy-duty powerbank (uses grade A battery) + 5W wireless charging, and made with FSC certified natural bamboo material and ABS for a great finish. Smart indicator shows you the remaining energy level. Uses advanced Biomaster anti-microbial technology that continuously protects against harmful micro-organisms for life. Input: Micro USB 5V/2A, Type-C 5V/2A. Output: USB 5V/2.4A. Wireless Output: 5W 5V/1A.

Print Technique : UV, SC, ENG  
Max Print Size : 40 X 50 mm

Preferred Print Location : Front  
Product Size : 1.5 X 6.5 X 10.1 cm

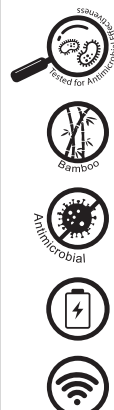

ITPB 837 - ASKAS

©MEMORI 8000 mAh heavy-duty powerbank + 5W wireless charger, made with FSC certified natural bamboo material and ABS for a great finish. Smart indicator shows you the remaining energy level. Uses advanced Biomaster anti-microbial technology that continuously protects against harmful micro-organisms for life. Inputs: Micro USB 5V/2A, type C 5V/2A. Output: USB 5V/2.4A. Wireless output: 5W 5V/1A

Print Technique : UV, SC, ENG  
Max Print Size : 60 X 50 mm

Preferred Print Location : Front  
Product Size : 2 X 8 X 15 cm

READY STOCK



# POWERBANKS



- Excellent Branding Space on Tempered Glass Surface
- Latest Type-C Input & Output
- Capacity : 10,000 mAh



### ITPB 823 - RODEZ

@MEMORI Rodez is a 10000mAh powerbank with a front Scratch-Proof Tempered Glass surface that can be branded edge to edge for optimal brand exposure. The back of the powerbank has a smooth rubberized finish for a comfortable user experience. Dual USB Input-5V/2A, Micro USB Input- 5V/2A, Type-C Input & Output- 5V/2A

Print Technique : UV, SC Preferred Print Location : Front  
 Max Print Size : 90 x 63 mm Product Size : 9 x 6.3 x 2.2 cm  
 Packing Details : 23 x 13 x 23.3 cm ; 21 pcs /carton ; gw/nw: 4.9 kg / carton



CREATIVE  
QUALITY

- Excellent Branding Space on Tempered Glass Surface
- Dual USB Output
- Capacity : 6000 mAh

COMMUNICATE YOUR BRAND MESSAGE EFFECTIVELY ON TEMPERED GLASS SURFACE



### ITPB 822 - CHOLET

@MEMORI Cholet is a 6000mAh powerbank with a front Scratch-Proof Tempered Glass surface that can be branded edge to edge for optimal brand exposure. The back of the powerbank has a smooth rubberized finish for comfortable user experience. Dual USB Output-5V/2A, Micro USB Input- 5V/2A.

Print Technique : UV, SC Preferred Print Location : Front  
 Max Print Size : 140 x 69 mm Product Size : 14 x 7 x 1 cm  
 Packing Details : 27 x 17 x 18 cm ; 23 pcs /carton ; gw/nw: 4.8 kg / carton

READY STOCK

QUALITY



### ITPB 825 - COMRAT

@MEMORI Keep your phone charged with this eco 5W wireless powerbank. The powerbank comes with 2 charging options: wireless 5W charging, and dual regular USB port 2A output for fast charging. The casing is made out of durable bamboo. Wireless charging compatible with all Qi enabled devices like Android latest generation, iPhone 8, 8S and X. Input: 5V/2A (Micro in), USB output: 5V/2A Type-c input: 5V/2A, Wireless output: 5W (5V/1A)

Print Technique : UV, SC, ENG Preferred Print Location : Front Max Print Size : 60 X 90 mm  
 Product Size : 14 X 7.2 X 1.45 cm Packing Details : 34.5 X 17 X 13.5 cm ; 28 pcs / carton ; gw / nw : 4.75 kg / carton



- Natural Bamboo Material
- LED Available Power Display
- 6000 mAh Power Bank; 5W Wireless Charger
- Dual USB Input ; Type-C & Micro USB Output

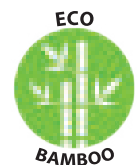





READY STOCK

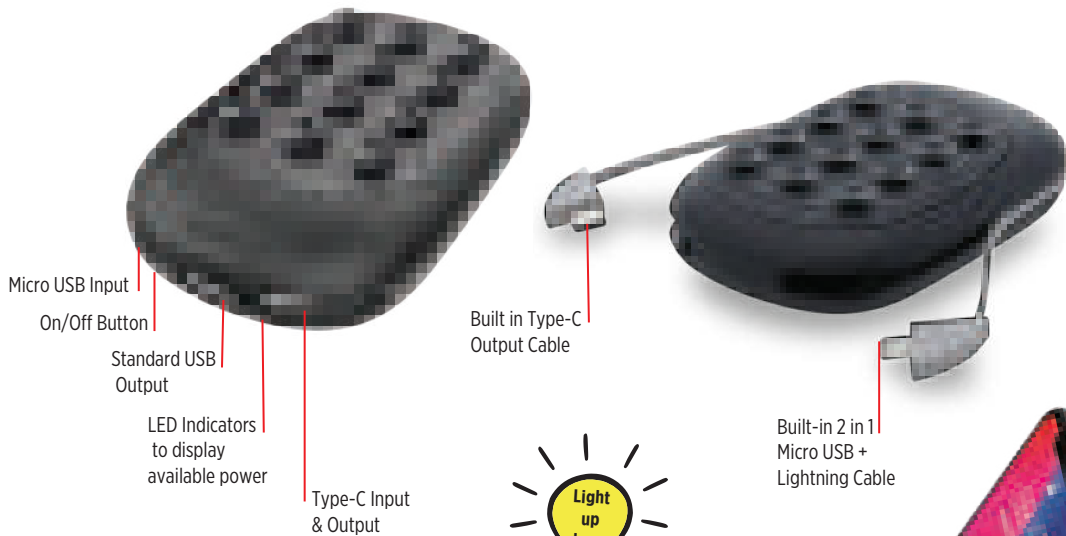

- > 10000 mAh Powerbank
- > Built-in Wireless Charger
- > Built-in Type-C + Micro USB + Lightning Cable
- > Light-up Logo For Optimal Brand Exposure
- > Compact Design & Suction Cups On Back To Securely Hold Your Phone



Scan Below QR code to watch product video



ITPB 813 - TARSUS

@MEMORII Tarsus is a 10000 mah wireless powerbank with light-up logo function for optimal brand exposure. The built-in Micro USB, Lightning and Type C cables ensure any digital device can be charged without scouting for the cable. Packed in a Gift box. Input & Output- 5V/2.1A, Wireless Output- 5V/1A 5W.

Print Technique : SC, ENG, UV

Preferred Print Location : Front

Product Size: 10.6 X 6.8 X 3 cm

Packing Details : 37.5 X 13 X 16.5 cms ; 18 pcs / carton ; gw / nw : 4.6 kg / carton



# WIRELESS CHARGING POWERBANKS



QUALITY



ITPB 801 - 8000mAh



ITPB 802 - 12000mAh

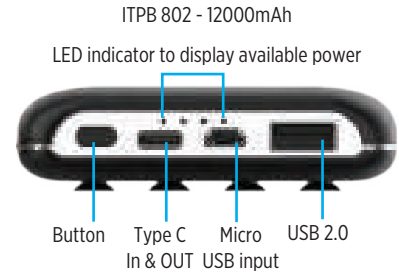
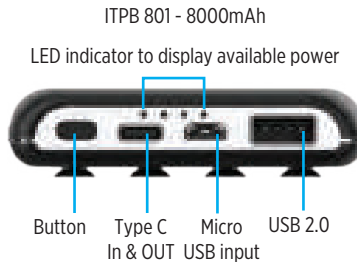

- Light-Up Logo When Engraved
- 8000 mAh And 12000 mAh Available
- 5 Watt Wireless Charger
- Suction Cups On Back
- Type-C Input & Output For All Modern Phones

READY STOCK



ITPB 801 - 8000mAh



ITPB 802 - 12000mAh

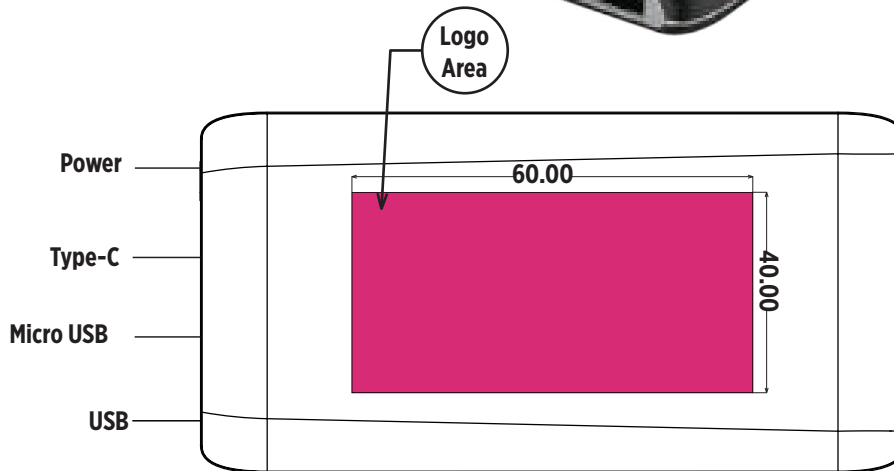

### ITPB 801 - NACKA

@MEMORii Nacka is a Light-Up logo powerbank that includes the latest technologies in charging: type C and wireless charging. The powerbank has a 8000 mAh lithium battery that can be charged both via micro USB and type-C port. The suction pad allows you to place your mobile on the device while charging wirelessly. Including battery level indicator. Compatible with all Qi enabled devices like Android latest generation, iPhone 8, 8S and X. Input: 2A. Output: 5V/2.1A. Wireless Output: 5V/1A 5W.

Print Technique : UV, SC, ENG Preferred Print Location : Front  
 Max Print Size : (LED Light-Up Logo) 40 x 60 mm Product Size : 14.1 X 1.6 x 7.2 cm  
 Packing Details : 21.5 x 19.5 x 20 cm ; 18 pcs /carton ; gw/nw: 5 kg / carton

### ITPB 802 - VISBY

@MEMORii Visby is a Light-Up logo powerbank that includes the latest technologies in charging: type C and wireless charging. The powerbank has a 12000 mAh lithium battery that can be charged both via micro USB and type C port. The suction pad allows you to place your mobile on the device while charging wirelessly. Including battery level indicator. Compatible with all Qi enabled devices like Android latest generation, iPhone 8, 8S and X. Input: 2A. Output: 5V/2.1A. Wireless Output: 5V/1A 5W.

Print Technique : UV, SC, ENG Preferred Print Location : Front  
 Max Print Size : (LED Light-Up Logo) 40 x 60 mm Product Size : 14.9 X 1.9 x 7.7 cm  
 Packing Details : 19.5 x 19.5 x 20 cm ; 16 pcs /carton ; gw/nw: 5 kg / carton

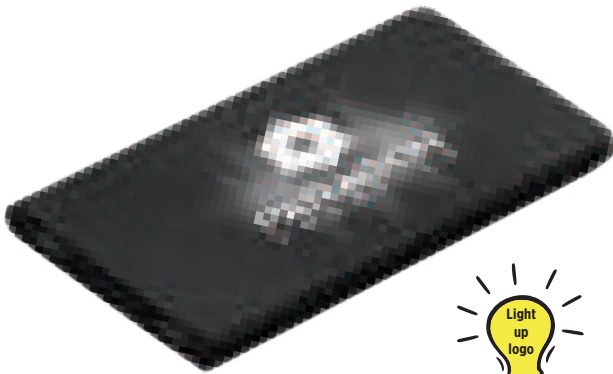

- > Big Light-Up Logo Space.
- > Light-Up logo When Engraved
- > 4000 mAh Powerbank Capacity
- > Ultra Slim Powerbank With Rubber Finish



ITPB 803 - DRYDEN

@MEMORii Dryden is a 4000 mAh ultraslim powerbank with smooth rubber finish. The logo lights up when connected thus providing optimal brand exposure. Input: 5V/1A and output 5V/2A, 5V/1A.

Print Technique : UV, SC, ENG Preferred Print Location : Front  
 Max Print Size : (Light-Up logo) 80 x 38 mm Product Size : 14 x 6.8 X 0.9 cm  
 Packing Details : 35 x 14 x 16 cm ; 32 pcs / carton ; gw / nw ; 4.3 kg / carton

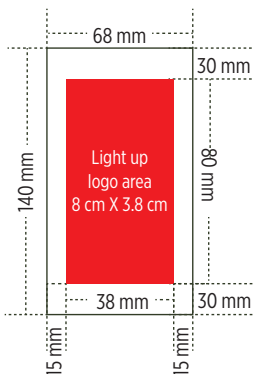

Light Up Your Brand !!

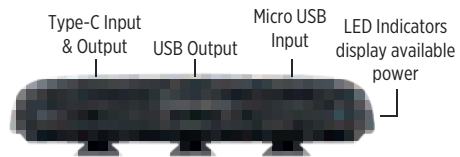

- > Large LED Panel To Light Up Logo When Engraved
- > 5000 mAh Powerbank
- > Type-C Output For All Modern Phones
- > Suction Cups On Back
- > Integrated Cable With Micro USB And Lightning Output
- > Fast Charge Input And Output

Suction Cups to hold your phone

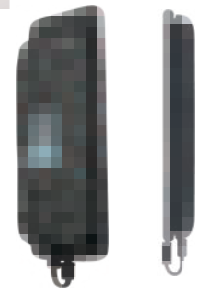

QUALITY

VALUE

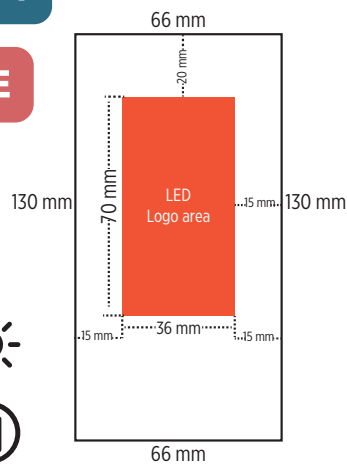

Scan Below QR code to watch product video



Integrated cable with 2 in 1 Lightning and micro USB output



ITPB 463 - SOPOT

@MEMORii Sopot powerbank has the option for an engraved logo on the front panel. When using the powerbank the logo will Light-Up, highlighting your brand in a great way. A set of 4 LED indicators display available power. The suction cups will firmly hold your device in place with the power bank which fits right in your palm or your pocket. Input : 5V/2A (Micro), 5V/3A (Type-C); Output : 5V/2A (Standard USB).  
 Print Technique : UV, SC, ENG Preferred Print Location : Front  
 Max Print Size : (LED Light-Up Logo) 70 x 37 mm Product Size : 13 x 6.6 x 1.25 cm  
 Packing Details : 35 X 13 X 21.5 cm ; 20 pcs / carton ; gw / nw : 4.9 kg / carton

READY STOCK



# POWER BANKS



Silver

Black

SQUIP

ITPB 460 - Black ITPB 462 - Silver

@MEMORII Squip is a 8000 mAh powerbank with USB 2.0 input and Type-C output. The integrated cable has both Micro USB and lightning input. A set of 4 LED indicators display available power. The suction cups will firmly hold your device in place with the power bank which fits right in your palm or your pocket. Input : 5V/2A (Micro), 5V/3A (Type-C); Output : 5V/2A (Standard USB).

Print Technique : UV

Preferred Print Location : Front

Max Print Size : 120 x 55 mm

Product Size : 13 x 6.6 x 1.25 cm

Packing Details : 35 X 13 X 21.5 cm ; 20 pcs / carton ; gw / nw : 4.9 kg / carton

- > 8000 mAh Powerbank
- > Type-C Output For All Modern Phones
- > Suction Cups On Back
- > Integrated Cable With Micro USB And Lightning Output
- > Fast Charge Input And Output

Integrated cable with 2 in 1 Lightning and micro USB output



Suction Cups to hold your phone



Scan Below QR code to watch product video



Type-C Input & Output

USB Output

Micro USB Input

LED Indicators display available power



READY STOCK

VALUE

QUALITY



9000 mAh

- TEMPERATURE PROTECTION
- SHORT CIRCUIT PROTECTION
- OVER VOLTAGE PROTECTION
- INPUT ANTI-PLUG PROTECTION
- OUTPUT OVER VOLTAGE PROTECTION
- OVER CHARGING DISCHARGING PROTECTION
- OVER CURRENT PROTECTION
- BATTERY PYC PROTECTION

ADD A FULL CHARGE OR MORE



ITPB 735 - 10POWER

@MEMORII 10 Power is a 9000mAh powerbank with dual USB output. The two ports can work at the same time. A set of four LED indicators display the available power. The international advanced power management technology provides overcharging protection, overcurrent protection, short-circuit protection etc. Output : 5V-2.4A (1 loading), 5V-3A (2 loading). Input 5V-2A.

Print Technique : UV, SC

Preferred Print Location : Front

Max Print Size : 125 x 63 mm

Product Size : 15.2 x 7.2 x 1.2 cm

Packing Details : 24.5 X 19 X 18.5 cm ; 16 pcs / carton ; gw / nw : 4.5 kg / carton



> 10000 mAh Powerbank Capacity

> Fast Charge 2.1A Output



ITPB 810 - VIBORG

@MEMORII Viborg is a 10000 mAh powerbank with a sturdy body & fast charging capacity. Input: 5V/2A; Output: 5V/1A, 5V/2.1A.

Print Technique : UV, SC

Preferred Print Location : Front

Max Print Size : 115 x 60 mm

Product Size : 13.2 x 6.8 x 1.9 cm

Packing Details : 21 x 19 x 23 cm ; 16 pcs / carton ; gw / nw : 4.90 kg / carton



Giftology



- 8000 mAh Powerbank
- Wireless input and output charging

**ITPB 812 - APOLDA**  
 Giftology Durable 8000 mAh powerbank for a great promotional campaign. Supports 5W wireless charging and comes with one USB ports to also allow charging by cable. When fully charged it will provide you with enough energy to re-charge your mobile phone up to four times. The power bank contains a long-lasting grade A 8000 mAh high-density lithium polymer battery. The power indicators will indicate the remaining energy level so you always know when to re-charge. Micro USB port-in: 5V/1.5A Output: 5V/2.1A. Wireless output 5W 5V/1A.  
 Print Technique : UV, SC Preferred Print Location : Front  
 Max Print Size : 40 x 30 mm Product Size : 13.5 x 7.3 x 1.8 cm  
 Packing Details : 21.5 x 20 X 19 cm; 20 pcs/carton; gw/nw: 4.89 kg/carton



Giftology

Micro input: DC 5V-2.1A  
 Type C input: DC 5V-2.1A  
 USB output: DC 5V-2.1A  
 USB output: DC 5V-2.1A

- 10000 mAh Powerbank
- Dual Type -C & Micro USB Input
- Dual USB Output
- Value Deal!!



**ITPB 824 - LAMIA**  
 Giftology Lamia is a 10000mAh powerbank with metal casing and A grade lithium polymer battery. The powerbank has integrated battery level indicators to show the remaining energy. Type-C Input: 5V/2.1A. Micro USB Input 5V/2.1A. Dual USB Output 5V/2A.  
 Print Technique : UV, SC, ENG Preferred Print Location : Front  
 Max Print Size : 120 x 62 mm Product Size : 13.8 x 6.7 x 1.6 cm  
 Packing Details : 25 x 25 X 39 cm; 26 pcs/carton; gw/nw: 8.3 kg/carton

READY STOCK

VALUE  
 QUALITY

@MEMORII

Scan Below QR code to watch product video

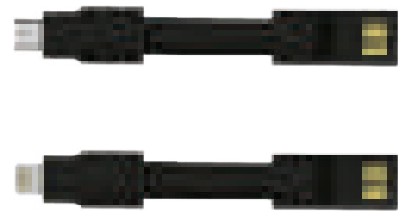

Integrated cable with 2 in 1 Lightning and micro USB output

- 5 WATT Wireless Charger ((☎))
- 5000 mAh Powerbank
- Type-C Input & Output For All Modern Phones
- Suction Cups On Back
- Integrated Cable With Micro USB And Lightning Output
- Fast Charge Input And Output



**WARSAW**  
**ITPB 464 - Black** **ITPB 465 - Silver**  
 @MEMORII Warsaw features a USB 2.0 input and Type-C output. The integrated cable has both Micro USB and lightning input. A set of 4 LED indicators display available power. The suction cups will firmly hold your device in place with the power bank which fits right in your palm or your pocket. Input : 5V/2A (Micro), 5V/3A (Type-C); Output : 5V/2A (Standard USB) 1A (Wireless 5 WATT Output).  
 Print Technique : UV Preferred Print Location : Front Max Print Size : 120 x 55 mm  
 Product Size : 13 x 6.6 x 1.25 cm Packing Details : 35 X 13 X 21.5 cm ; 20 pcs / carton ; gw / nw : 4.9 kg / carton

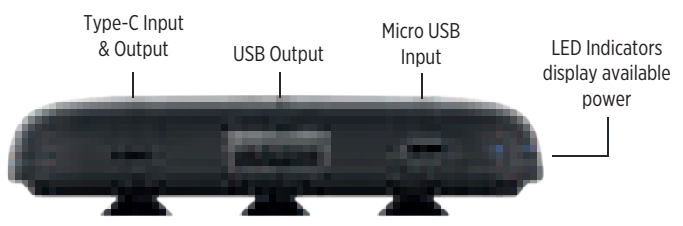



# POWER BANKS



When the input of Dobble is connected to power supply & output is connected to your phone and once the phone is fully charged, a unique chip automatically cuts off phone charging & starts charging your power bank

XDDDESIGN®

Scan Below QR code to watch product video



Green



Grey



- > 3000 mAh Powerbank
- > Samsung Battery
- > Integrated Connectors



DOBBLE

ITXD 504 - Grey ITXD 506 - Green

XDDDESIGN® Dobble is a two way charger power bank, covered with a microfiber mat. Dobble avoids running out of power by combining charging cables and a powerful 3000mAh Samsung battery in one. Daily use the cable to charge your phone and once full it will automatically charge the internal battery. Output 5V/0.6A, input 5V/1A. Registered design®

Print Technique : UV,SC

Preferred Print Location : Microfiber Mat

Max Print Size : 110 x 50 mm

Product Size : 4.5 x 9 x 3.9 cm

Packing Details : 38 x 20 x 26 cm ; 100 pcs /carton ; gw/nw : 11.6 kg / carton

READY STOCK

## VALUE



- > 4000 mAh Powerbank
- > Edge To Edge Printing Possible
- > With Micro Usb Cable Compartment
- > Notebook Look ; With Sticky Notes

Red

Blue



BUKIE

ITPB 791 - Red ITPB 792 - Blue

@MEMORII Bukie is a 4000 mAh powerbank that looks like a notebook and is therefore a perfect business accessory. It comes with sticky notes, a smartphone holder and also contains a cable to connect your smartphone. A nice and playful gift. Input 5V/1A; output 5V/1A.

Print Technique : SC, UV, ENG, EMB Preferred Print Location : Front

Max Print Size : 135 x 92 mm

Product Size : 14 x 9.5 x 1.7 cm

Packing Details : 34.5 X 25.5 X 14.5 cm ; 20 pcs / carton ; gw / nw : 4.8 kg / carton



- > 2200 mAh Powerbank
- > Light-Up Your Logo
- > Wirelessly Charge Powerbank
- > Excellent Branding Space
- > Two USB Port On Charging Base

Grey



Light up logo !!

Blue



PINSK

ITPB 793 - Grey ITPB 794 - Blue

@MEMORII Pinsk is a 2200 mAh powerbank that can be charged wirelessly on a docking station. Just place the powerbank on the docking station and the powerbank connects to the magnetic pins to start charging. The docking station has 2 USB outputs that can be used to charge your digital devices. The powerbank can also be charged with the micro USB cable. Input /output: 5V/1A.

Print Technique : SC, UV, DM Preferred Print Location : Front

Max Print Size: 15 x 70 mm

Print Technique : SC, UV Preferred Print Location : Charging Base

Max Print Size : Dia 37 mm Product Size : 9.7 x 3.5 x 2.2 cm

Packing Details : 32 X 27 X 12 cm ; 25 pcs / carton ; gw / nw : 4 kg / carton



**POWERBANK, SPEAKER CUM TRAVEL ADAPTER**

- > 3 Watt Bluetooth Speaker
- > Made From Fire Retardant Pc Materials
- > Included Rechargeable connectors for UK, EU, USA and AUS/NZ plugs



ITTA 161 - VALGA

@MEMORI Valga is a wall charger with 3000mah powerbank and 3 Watt bluetooth speaker. Consists of rechargeable connectors for UK, EU, USA and AUS/NZ plugs. Made from fire retardant PC materials. Packed in a gift box.  
 Print Technique : UV, SC Preferred Print Location : Front Bottom / Side  
 Max Print Size : (Bottom) 8x20mm (Side) 40x10mm Product Size : 83 x 72 x 45cm  
 Packing Details : 61.7 x 23.7 x 8.1 cms; 18pc/carton; gw/nw: 4.90 kg / carton

- > Treated with Biomaster Antimicrobial Technology from UK
- > FSC Certified Bamboo
- > Fashion 3W speaker with 4 hours playtime



ITSP 162 - KOBRYN

@MEMORI Natural FSC Certified bamboo 3W speaker with built-in 500 mAh lithium battery. With playing time up to 4 hours on one single charge and operating distance of 10m using BT5.0. This product contains Biomaster antimicrobial technology that provides protection against the growth of harmful micro-organisms for the lifetime of the product.  
 Print Technique : SC, ENG Preferred Print Location : Front Top  
 Max Print Size : 45 x 10 mm Product Size : 12 x 4 x 8 cm

READY STOCK

**VALUE**

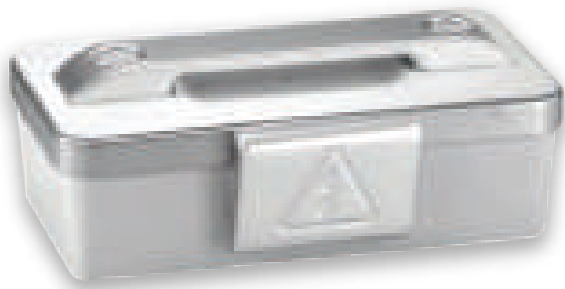

- > 3100 mAh Portable Power Bank
- > 4 Integrated Connectors Compatible With Most Devices



UD 748 - KEF

Portable Power Bank -Power storage device that comes with 4 adaptors (Apple products, micro USB, mini USB and female USB). Charges your devices on the go and is portable for travel use.  
 Print Technique : UV, SC Preferred Print Location : Top  
 Max Print Size : 45 x 15 mm Product Size : 9.5 x 5.5 x 3 cm  
 Packing Details : 34.x30.5 x 25 cm; 50 pcs/carton; gw/nw: 9.2 kg/carton

XDDESIGN®



- > 2500 mAh Solar Powerbank
- > Made From Eco-Friendly Materials
- > Perfect Desk Accessory

UD 787 - SUNFLOWER

XDDESIGN® Sunflower brings solar energy to your desk with a smile! The 2500mAh rechargeable lithium battery inside is powerful enough to easily charge your mobile phone or MP3 player. The solar charger has a USB output and mini-USB input. Including mini USB cable. Registered design®  
 Print Technique : SC,UV Preferred Print Location : Front  
 Max Print Size : 25 x 20 mm Product Size : 10 x 23 x 10 cm  
 Packing Details : 48.3 x 40.6 x 52 cm ; 24 pcs /carton ; gw/nw: 12.9 kg / carton



# WIRELESS / BLUETOOTH SPEAKERS



- Power : 3W
- 4400 mAh Powerbank
- Microphone For Handsfree Calling



BOOMSOND

ITSP 120 - Silver/white

@MEMORii BoomSound is a 3W bluetooth speaker with 4400mah power bank and a phone stand. It is sleek and easy to carry. It also features an aux-in cable which allows the speaker to be played from your audio device even when your speaker runs out of power! Packed in a gift box.

Print Technique : UV, SC Preferred Print Location : Back  
Max Print Size : 110 x 55 mm Product Size : 13.2 x 7.5 x 2.3 cm  
Packing Details : 30 x 24.8 x 10.5 cm ; 10 pcs /carton ; gw/nw: 3.5 kg / carton



Scan Below QR code to watch product video



- 3 Watt Wireless Speaker
- Light Up Logo Possibility For Optimal Brand Prominence
- With Microphone To Attend To Calls

ITSP 181 - MATERA

@MEMORii Matera is a 3 WATT Bluetooth speaker with an impressive 3 hours playtime on one single charge and operating distance of 10m. It is an ideal gift for promotions because of the possibility to have a Light-Up logo giving the brand its prominence and leaving a lasting impression of the brand on the user's mind. Including ambient changing light. With microphone to answer incoming calls.

Print Technique : UV Preferred Print Location : Front  
Max Print Size : (LED Light-Up Logo) 30 x 30 mm Product Size : ø7.3 X 4 cm  
Packing Details : 35.5 x 21.5 x 31 cm ; 60 pcs /carton ; gw/nw: 7.6 kg / carton

READY STOCK

## Giftology

VALUE

## Giftology

6 Watts

Silver



White



Play Modes:

- BT
- TF
- Aux Cable
- USB

ASTA

ITSP 107 -White ITSP 108-Silver

Giftology Asta soundbar with 2\*3W bluetooth speakers and 1200 mAh battery. Functions include Handsfree calling, 3.5mm Line in, USB/TF card play mode. Can also be used with the included audio cable. Packed in a nice gift box.

Print Technique : UV, SC Preferred Print Location : Front  
Max Print Size : 50 x 12 mm Product Size : 31.6 x 5.5 x 4 cm  
Packing Details : 35.5 x 38 x 15.5 cm ; 10 pcs /carton ; gw/nw: 5 kg / carton

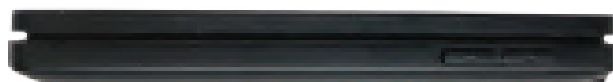

Black



White



BARRIE

ITSP 801 - White ITSP 802 - Black

Giftology Display your brand effectively with this 3 watt Wireless speaker that has a flat front to allow you to effectively communicate your brand message. With 350 mAh battery that allows up to 4 hours playing of your favourite music. Operating distance up to 10 meters. Includes micro cable to charge the speaker. Compatible with all mobile phones.

Print Technique : UV, SC Max Print Size : 100 x 51mm  
Product Size : 10 x 5.1 x 1.3cm Preferred Print Location : Front  
Packing Details : 35 X 23 X 26 cm ; 100 pcs / carton ; gw / nw : 7.3 kg / carton



# MULTIFUNCTIONAL SPEAKER / POWERBANK / USB FLASH DRIVES



**VALUE**



**Dancing Speaker !!**



**ITMK 108- PLEIKU**  
 Bluetooth Speaker with 3W Power . When music is played, the speaker sets in motion to give a dancing look.  
 Print Technique : UV, SC Preferred Print Location : Front  
 Max Print Size : 35 X 50 mm Product Size : 12 x 8 x 9 cm  
 Packing Details : 34 X 26 X 58 cm; 500pcs/carton; gw/nw: 16kg/carton



**ITMK 106 - JUNIK**  
 Compact Bluetooth docking speaker with outside surface especially designed for laser printing to illuminate the marked logo. Bicolor design with smooth finish and bluetooth 3.0 connection, offers 3W power, hands-free function, a micro SD card slot up to 32GB, FM radio function, auxiliary line input via 3.5mm jack connection and non-slip rubber mounts on the base. Compatible with iOS and Android, includes mini USB charging cable, 3.5mm auxiliary jack cable and comes in an attractive design box.  
 Print Technique : SC, ENG, UV Preferred Print Location : Center  
 Max Print Size : 25 X 20 mm (Light-up) Product Size : 5.1 x ø6.2 cm  
 Packing Details : 34 X 16 X 34 cm; 50 pcs / carton; gw / nw : 7.5 kg / carton

**XD COLLECTION**



- > 2500 mAh Powerbank
- > 8 GB USB 2.0 Flash Drive
- > Excellent Branding Space

Black White



**DUBBO**  
**ITXD 750 - Black ITXD 751 - White**  
 XD Thin 2500 mAh powerbank with detachable 8 GB USB 2.0 flash drive. ABS material. Output 1V/1A and input 5V/1A. Including micro USB cable. design®  
 Print Technique : UV, SC Preferred Print Location : Front  
 Max Print Size : 75 x 55 mm Product Size : 11.3 x 6 x 0.8 cm  
 Packing Details : 46.5 x 39 x 18.5 cm; 100 pcs /carton; gw/nw: 9.5 kg / carton

**XDDESIGN®**



- > Available in 4GB Flash Drive
- > Includes Touch Pen
- > Excellent Branding Space



**ITXD 815 - STYLO-4GB**  
 XDDESIGN® Stylo brings traditional writing and current technology together in one pen. Small notes or a quick sketch can be made with the ballpoint on paper or with the precision touch pen on your phone or tablet. On top of that all your data can be stored on the 4GB USB stick. Registered design®  
 Print Technique : UV, SC, ENG Preferred Print Location : Clip  
 Max Print Size : 25 x 8 mm Product Box Size : 21 x 4.6 x 2.6 cm  
 Packing Details : 0.037 cbm; 100 pcs /carton; gw/nw: 8 kg / carton

**READY STOCK**



# USB FLASH DRIVES

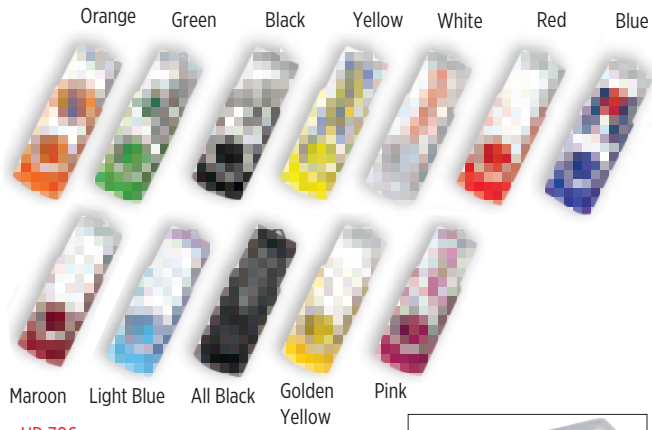

### UD 706

The Classic Budget USB Flash Drive  
Print Technique : UV, SC, ENG  
Preferred Print Location : Center  
Max Print Size : 22 x 12 mm  
Product Size : 2 x 5.5 x 1 cm



### ITFD 541 - Black ITFD 542 - White ITFD 543 - Silver ITFD 544 - Blue ITFD 545 - Red

Metal USB Flash Drive  
Print Technique : UV, SC, ENG  
Preferred Print Location : Front Center  
Max Print Size : 23 x 8 mm  
Product Size : 3.9 x 1.2 x 0.5 cm

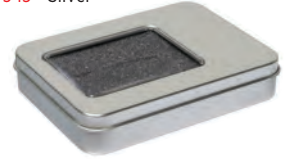

READY STOCK

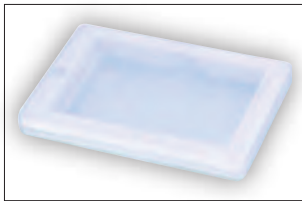
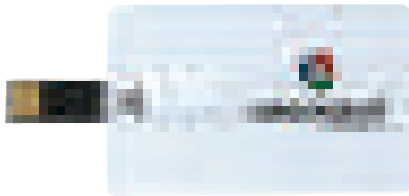

### UD 740

Plastic Credit Card Shape USB Flash Drive  
Print Technique : UV, SC  
Preferred Print Location : Center  
Max Print Size : 70 x 40 mm



### UD 753

Key Shape Metal USB Flash Drive  
Print Technique : UV, SC, ENG, DM  
Preferred Print Location : Center  
Max Print Size : 30 x 5 mm  
Product Size : 5.7 x 2.5 x 0.3 cm



### UD 952

Metal USB Flash Drive  
Print Technique : UV, SC, ENG, DM  
Preferred Print Location : Front Center  
Max Print Size : 25 x 11 mm  
Product Size : 4.7 x 1.2 x 0.4 cm



Black



Royal Blue



### UD 764

Wristband USB Flash Drive  
Print Technique : SC  
Preferred Print Location : On Band  
Max Print Size : 150 x 15 mm  
Product Size : 22 x 1.8 x 0.8 cm

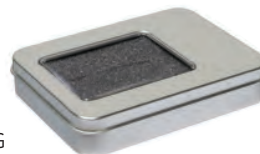
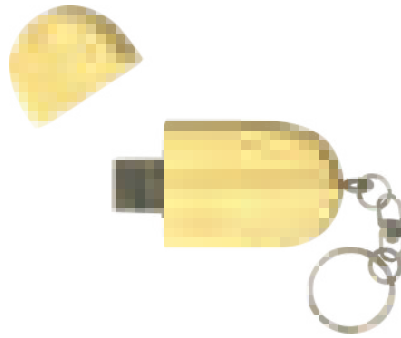

### ITFD 540

Bamboo USB Flash Drive  
Print Technique : SC, UV, ENG  
Preferred Print Location : Front  
Max Print Size : 30 x 18 mm  
Product Size : 6 x 3 cm



### ITFD 550

Wooden USB Flash Drive  
Print Technique : SC, UV, ENG  
Preferred Print Location : Front  
Max Print Size : 50 x 19 mm  
Product Size : 6.3 x 2.2 cm



SANTHOME

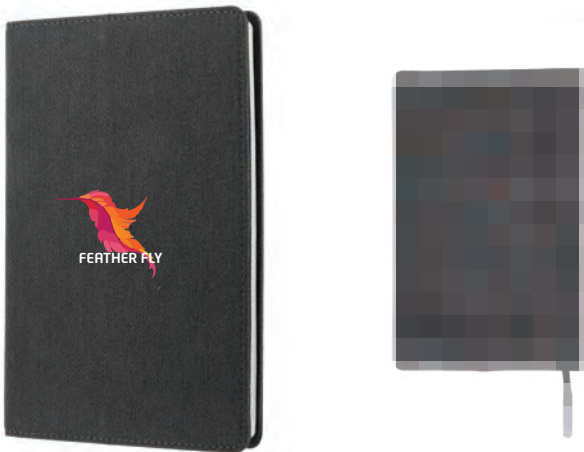

FEATHER FLY

- > Refillable A5 Notebook
- > 5W Wireless Charger Built in to the Notebook
- > 160 Pages ; 70 gsm



NBSN 905 – PESSAC

SANTHOME Pessac is a unique A5 refillable notebook with 5 Watt wireless charger. Made from premium interwoven fabric for smooth touch. Notebook consists of 80 sheets/160 pages each of 70 gsm. Input: 5V/1A; Wireless output: 5W.

Print Technique : SC Preferred Print Location : Front  
 Max Print Size : 115 x 180 mm Product Size : 21 x 13.5 x 1.4 cm  
 Packing Details : 42 X 33 X 25 cm; 40 pcs/carton; gw/nw: 14 kg/carton



Giftology

esasa

- > A5 Hard Cover Notebook
- > Taiwan - Made Sandisk 16GB USB Flash Drive
- > Ruled 160 Pages Each 70 gsm
- > Elastic Closure



READY STOCK

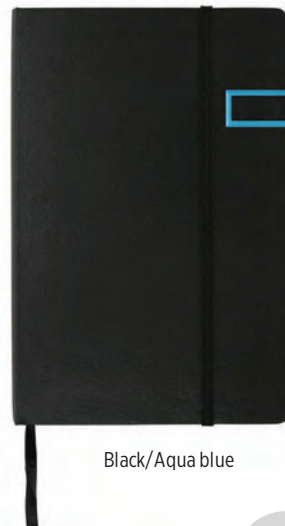

Black/Aqua blue



Black/Grey

A5

SENTA

NBGL 211 - Black/Grey NBGL 212 - Black/Aqua blue

Giftology Senta is an A5 notebook with 16GB Original Taiwan made Sandisk USB flashdrive. The notebook consists of 160 pages each 70 gsm.

Print Technique : UV, SC Preferred Print Location : Front  
 Max Print Size : 140 x 205 mm Product Size : 13 x 21 x 1.4 cm  
 Packing Details : 44 x 41 x 16 cm; 50 pcs/carton; gw/nw: 13.9 kg/carton



# PORTFOLIO POWERBANKS

## XD Technology

**QUALITY**

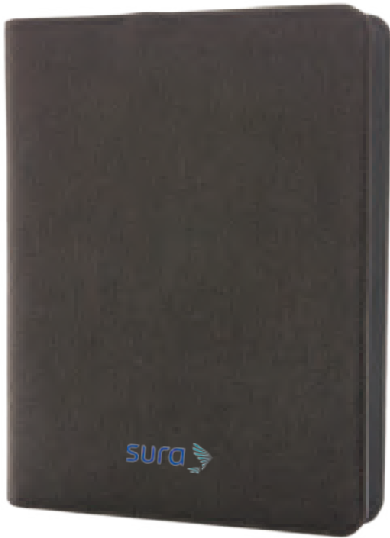

- > 3000 mAh Built-In Powerbank
- > A5 Ruled Notebook
- > Endless Usage, Refillable Notebook Sleeve
- > Unique Business gift

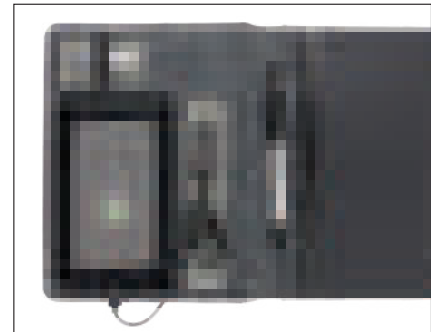

### ITXD 702 - POWERBOOK

**XD Technology** Write your daily notes and charge your phone at the same time! This fabric notebook contains 128 pages cream paper of 80g/m2 and a built in powerbank with 3000 mAh. Comes with handy see-through window phone pocket (15 x 8cm) which allows you to view and access your device anytime. Output: 5V/1A

Print Technique : SC Preferred Print Location : Front Max Print Size : 140 x 180 mm  
Product Size : 22.8 x 17.8 x 2.0 cm Packing Details : 38 X 35 X 25 cm ; 20 pcs / carton ; gw/nw : 11.52 kg / carton

**READY STOCK**

## Giftology

**VALUE**



- Phone / Tablet Stand
- Wireless Charging
- Card Slots

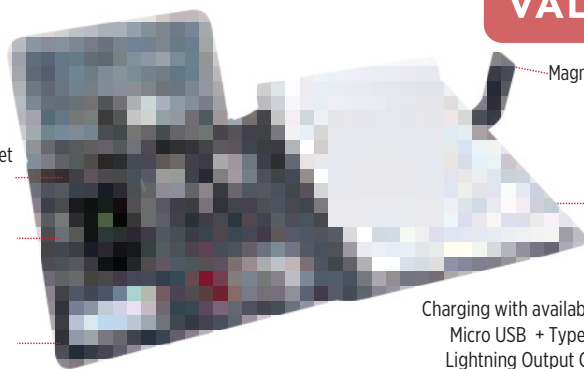

Magnetic Closure

A4 notepad

Charging with available 3 in 1 Micro USB + Type-C + Lightning Output Cable

A4



Power button with 4 LED Indicators



Scan Below QR code to watch product video

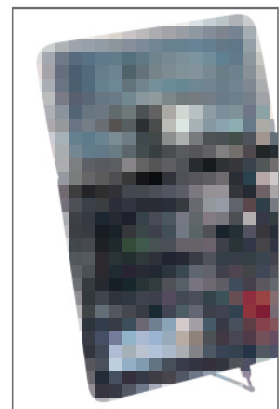

### ITGL 901 - VOLOS

**Giftology** Volos is an A4 Tech-Folder with 5W wireless charger & 4000mAh powerbank which can be used to charge your phone / tablet wirelessly or with cable. Just place your Qi compatible device on the wireless charging pad or connect your device to integrated Type-C or 2 in 1 cable with Lightning & micro USB ports to charge via Powerbank. In addition, Volos features an A4 refillable Notepad, a tablet/phone stand & 5 credit card slots. Input/Output : 5V/2A.

Print Technique : SC, ENG Preferred Print Location : Magnetic closure Max Print Size : Light-Up Logo 44 X 17 mm  
Product Size : 31 x 23 x 1.9 cm Packing Details : 65 x 27x 34 cm; 20 pcs/carton; gw/nw: 17 kg/carton



Scan Below QR code to watch product video



QUALITY

VALUE

- > 10000 mAh Powerbank
- > A5 Organizer
- > Integrated Lightning + Micro USB + Type-C Connectors



READY STOCK



Center flap to store mobile phone, cables, travel documents etc

Input charging USB cable  
Output charging Micro USB and Type C connectors  
Output charging for all latest iPhones

ITGL 902 - AIGIO

Giftology Aigio is an A5 notebook organizer with a built in 10000 mAh powerbank. It also has removable 120 pages each of 80 gsm. Integrated USB port for input charging along with Lightning, Micro USB & Type-C connectors capable of charging all available mobile phones & tablets. Aigio can fully charge an iphone or an android device atleast 2-3 times. An elastic band holds and secures everything. Input - 5V/2A; Output - 5V/2A.

Print Technique : SC, ENG, DM Preferred Print Location : Front Metal Plate Max Print Size : 20 x 30 mm  
Product Size : 23 X 18.8 X 2.3 cm Packing Details : 42 x 27 x 46 cm; 20 pcs/carton; gw/nw: 20 kg/carton



# POWER SERIES

CREATIVE

VALUE

- > 4400 mAh Wireless Powerbank
- > Refillable A5 Notebook
- > Smart Pockets To Keep Essentials

Scan Below QR code to watch product video

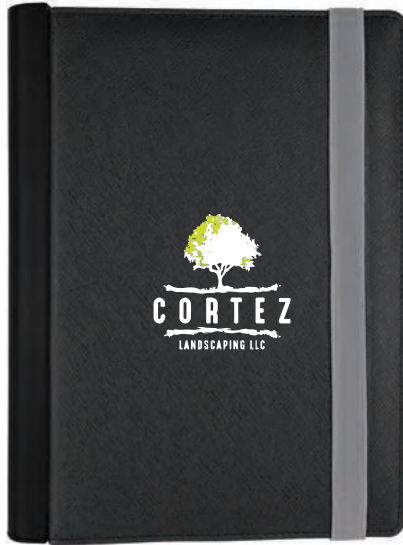

Wireless charging of digital devices



Wired charging of digital devices



ITGL 905- KESSEL

Giftology Write your daily notes and charge your phone at the same time! Kessel notebook contains 160 pages cream paper of 80g/m2, a built in powerbank with 4400 mAh capacity and a 5 Watt Wireless charger. Input: 5V/2A, Output (Wired): 5V/2A, Output (Wireless): 5 Watt. Packed in a gift box.

Print Technique : SC, ENG, UV

Preferred Print Location : Front

Max Print Size : 120 x 200 mm

Product Size : 24 x 18 x 2.5 cm

Packing Details : 43 X 28.5 X 37 cm ; 20 pcs /carton ; gw/nw: 15 kg / carton

READY STOCK

## QUALITY

For consumption in selected East & West African countries

Pierre Cardin  
PARIS

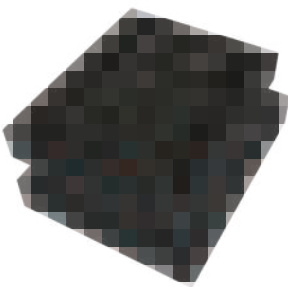

### FEATURES :

- > PIERRE CARDIN Folder with sliding handle for convenient carry
- > With modern PIERRE CARDIN pen
- > 8000mAh built-in powerbank
- > Integrated connectors to charge your digital devices
- > Integrated tablet holder
- > LED lights to display available power
- > PIERRE CARDIN paper pad

NANTES

ITPC 103 - Black ITPC 104 - Red/White

(Folder) Print Technique : SC, ENG

(Pen) Print Technique : UV, SC, ENG

Product Size : 28.7 x 22.5 x 4.5 cm

Preferred Print Location : Front

Preferred Print Location : Barrel

Packing Details : 56 X 26.5 X 32.5 cms ; 10 pcs / carton ; gw / nw : 14.1 kg / carton

Max Print Size : 50 x 30 mm

Max Print Size : 60 x 40 mm



For consumption in selected East & West African countries



**FEATURES :**

- PIERRE CARDIN Folder with PIERRE CARDIN pen
- Integrated 8GB USB flash drive
- 8000mAh built-in powerbank
- Integrated connectors to charge your digital devices
- Integrated tablet holder
- LED lights to display available power
- PIERRE CARDIN paper pad

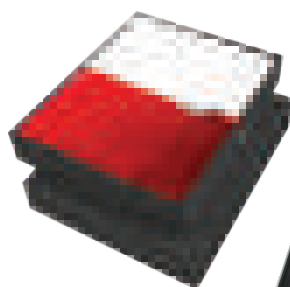

LOIRE

ITPC 102 - White/Red

(Folder) Print Technique : SC, ENG

(Pen) Print Technique : UV, SC, ENG

Product Size: 26 x 24 x 3 cm

Preferred Print Location : Front

Preferred Print Location : Barrel

Packing Details : 45 X 28.5 X 31.5 cms ; 10 pcs / carton ; gw / nw : 12.1 kg / carton

Max Print Size : 50 x 30 mm

Max Print Size : 60 x 40 mm

**QUALITY**

For consumption in selected East & West African countries

READY STOCK



**FEATURES :**

- Endless usage, refillable notebook sleeve
- 4000mAh built-in powerbank
- With modern PIERRE CARDIN pen and notebook
- See-through window phone pocket
- LED lights to display available power

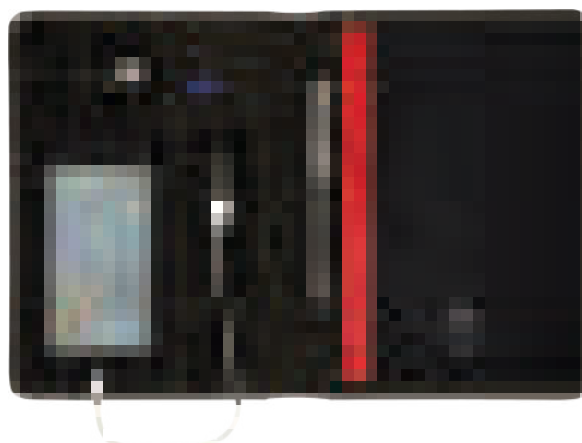

ITPC 105 - COLMAR

(Notebook) Print Technique : SC, ENG

(Pen) Print Technique : UV, SC, ENG

Product Size: 17.5 x 23.5 x 2.2 cm

Preferred Print Location : Front

Preferred Print Location : Barrel

Packing Details : 41 X 37.5 X 27 cms ; 18 pcs / carton ; gw / nw : 12.8 kg / carton

Max Print Size : 50 x 30 mm

Max Print Size : 60 x 40 mm



- Red Dot Design Award Winner
- Universal Tablet Holder
- Notepad Included
- Perfect Meeting Accessory !!

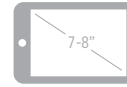
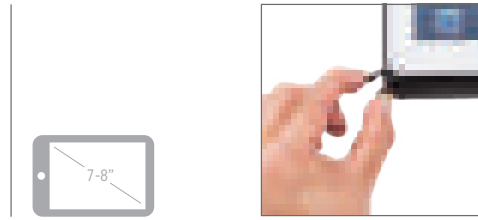

7-8"



9-10"



READY STOCK



FO 3325 - AXIS 9-10"

XDDDESIGN® Axis portfolio is made with recycled RPET material and has an integrated universal tablet holder, notepad and storage pockets. Makes for easy Organizing. This unique and patented system makes it possible to fit most 9-10" tablet. Registered design®

Print Technique : SC, HT Preferred Print Location : Front Left  
Max Print Size : 60 x 190 mm (<100 cm<sup>2</sup>) Product Size : 27.5 x 21 x 3 cm  
Packing Details : 36 x 33 x 31.3 cm ; 10 pcs /carton ; gw/nw: 6.75 kg / carton

Option of two sizes



FO 3326 - AXIS 7-8"

XDDDESIGN® Axis portfolio is made with recycled RPET material and has an integrated universal tablet holder, notepad and storage pockets. Organization has never been easier. This unique and patented system makes it possible to fit most 7-8" tablets. Registered design®

Print Technique : SC, HT Preferred Print Location : Front Left  
Max Print Size : 80 x 240 (<100 cm<sup>2</sup>) Product Size : 21.8 x 15.1 x 2 cm  
Packing Details : 36 x 34 x 25.60 cm ; 20 pcs /carton ; gw/nw: 8.31 kg / carton



XDDDESIGN®  
GENUINE LEATHER

7-8"



UI 1282 - KOMO 7-8"

XDDDESIGN® Komo Universal Portfolio is a stylish genuine leather portfolio with outer pockets and an integrated universal tablet holder that can be easily propped for presentations. The unique and patented system makes it possible to fit in most 7-8" tablets. Registered design®

Print Technique : SC,ENG Preferred Print Location : Front down Max Print Size : 120 x 40 mm  
Product Size : 21.8 x 14.4 x 2 cm Packing Details : 46 x 36 x 25 cm ; 18 pcs /carton ; gw/nw: 8.6 kg / carton





Contemporary Technology

READY STOCK

Scan Below QR code to watch product video



- Scalable Efficiency
- Draw / Write in Notebook
- Edit on Tablet / Mobile Phone
- E-mail Share with Colleagues /Friends
- Save as long as you like
- Access notes from anywhere
- Inbuilt Voice Recorder



OWMOL 101 - ELLIPSE SMART WRITING SET

The Smart Writing Set Ellipse is an instant-access kit containing the Pen+ Ellipse smart pen and a Large Ruled Paper Tablet with special Ncoded paper. Simply write on the pages of the Paper Tablet with the Pen+ Ellipse for instantly-digitized notes that can be edited, transcribed, organized and shared on your device of choice. The Pen+ Ellipse clips to the cover of the Paper Tablet, so you are always ready to jot down key points in a meeting, project brainstorming ideas, to-do lists, and whatever else fill the pages of your notebook. The Smart Writing Set Ellipse makes an instant and workable digital copy of every page bringing all the advantages of borderless digital creativity to your freehand notes, sketches, diagrams and doodles.

Product size : 26 x 26 x 3 cm



# AUTO TECH ACCESSORIES FOR SMART PHONES

Giftology



- > 5W Wireless Charger
- > Charge Hands-free And Without Cables
- > Gravity Induction Air Vent Mounting

Scan Below QR code to watch product video



ITWC 201 - ESTELI

Giftology Gravity induction 5 Watt wireless car charger that allows for a hands free safe car drive. The phone (up to 6") is held securely in place by the two holders on the side to keep the item stable when driving along with built-in LED indicator to indicate when the phone is charging. Input-Type C 5V/1A, Output-5V-1A/5Watts wireless.

Print Technique : UV, SC, ENG  
Product Size : 22.1 x 14.6 x 1.26 cm

Preferred Print Location : Plate  
Packing Details : 36.5 X22 X 40.5 cm; 24 pcs/carton; gw/nw: 4.9kg/carton

Max Print Size : 35 x 55 mm

READY STOCK

VALUE

## 5 in 1 Car Emergency Multitool



Seat belt cutter

Torch + Siren light



Car Charger



Glass breaker

2200mAh Powerbank



ITPB 405 - SHIELD

@MEMORII 6 in 1 Multifunctional car charger consisting of a car charger, 2200 mAh power bank, safety hammer, seat belt cutter, torch and emergency warning light. All the accessories required in emergency use are available in this compact device. Car charger input 12V-24V USB input 5V/1A USB Output 5V/1A

Print Technique : UV, SC  
Max Print Size : 25 x 13 mm

Preferred Print Location : Center  
Packing Details : 40 x 29 x 15 cm; 50 pcs /carton; gw/nw: 6.2 kg / carton

Product Size : 11.5 x 4 x 2.5 cm

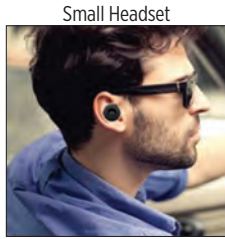

- > Safe Handsfree Experience
- > Bluetooth 4.0 For Smooth Connection
- > Charge And Call While Driving
- > Compatible With All Mobile Phones

ITCC 701 - FYCAR

**@MEMORII** Fycar is a unique design car charger with dual USB output and with integrated bluetooth headset that allows a safe hands-free experience whilst driving. The integrated earbud is charged when driving and is ultra-portable due to its small design (20 x 33 mm). The device uses the advanced bluetooth 4.0 connection which ensures a smooth connection and perfect sound quality. The magnetic top of the charger allows you to easily place the earbud back in the dock to charge it. The charger is suitable for all mobile phones. The earbud comes with additional ear tips in different sizes to fit all. Output 5V/1A ; 5V/2.1A

Print Technique : UV, SC, ENG Preferred Print Location : Front Max Print Size : 35 X 7 mm  
Product Size : 8.6 x ø 2 cm Packing Details : 37.5 x 30.5 x 17 cm ; 40 pcs/carton ; gw/nw ; 4.75 kg/carton



ITXD 740 - PENRITH

XD Car charger with Unique design & integrated wireless headset that allows a safe hands-free experience whilst driving. The integrated earbud is charged when driving and is ultra-portable due to its small design (20 x 33 mm). The magnetic top of the charger allows you to easily place the earbud back in the dock to charge it. The charger is suitable for all mobile phones. The earbud comes with additional ear tips in different sizes to get a good seal for all & can be used up to one hour on one single charge and can be fully re-charged in 1.5 hours. Output 5V/1A.

Print Technique : UV, SC, ENG Preferred Print Location : Front  
Max Print Size : 35 x 7 mm Product Size : 8 x ø2 cm  
Packing Details : 38.5 x 33.5 x 30 cm ; 80 pcs /carton ; gw/nw: 5.5 kg / carton



ITXD 741 - GRAFTON

XD Car charger with integrated wireless earbud using wireless BT 4.1 for perfect connection. The magnetic top of the charger allows you to easily place the earbud back in the dock to charge it. The charger is suitable for all mobile phones. The earbud comes with additional ear tips in different sizes to get a good seal. ABS material. Input 12-24V/output 2.1A. Registered design®

Print Technique : UV, SC, ENG Preferred Print Location : Front  
Max Print Size : 7 x 20 mm Product Size : 8 x 3 cm  
Packing Details : 55.0 x 35.0 x 21.0 cm ; 96 pcs /carton ; gw/nw: 8.6 kg / carton

READY STOCK



# AUDIO ACCESSORIES



**VALUE**

## WIRELESS SPORTS EARBUDS

Comfort, Ergonomic Design

Volume Buttons on earpod for easy control



Stereo headset

ITBH 781 - BEATEX

**@memori** Wireless sport earbuds play your favorite music with built in 100 mAh battery that allows you to use the gadget up to 5 hours. Bluetooth version 4.0. The App is compatible with IOS 9.0 and Android 4.4 and higher.

Print Technique : UV,SC Preferred Print Location : Right and Left Sides Max Print Size : 25 X 10 mm  
Product Size : 3.3 X 1.6 X 5.3 cm Packing Details : 38 x 23 x 62.3 cm ; 50 pcs / carton ; gw/nw: 11 kgs/ carton

READY STOCK



**VALUE**

- > Foam On Earpads For Comfort
- > 1.2m Long Aux Cable
- > Compact & Lightweight



ITBH 851- TORUN

**Giftology** Torun is a wired headphone with comfortable foam on the ear pad & 1.2m long aux cable length. The stylish head set is light weight & compact enough to carry or store easily .

Print Technique : UV, SC Preferred Print Location : Side Max Print Size : 30 x 30 mm  
Product Size : 14.5 x 16 x 7 cm Packing Details : 61 x 38.5 x 36 cm; 40 pcs/carton; gw/nw: 5.8 kg/carton

**Giftology**



Detach to find a USB cord to charge your bluetooth earphone

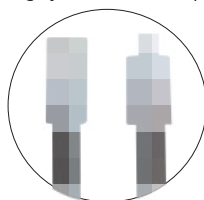

- > Wireless Bluetooth Earphones
- > Comes In A Portable Casing
- > Control Buttons On The Wire
- > Playtime : 2 Hrs
- > Value Deal !!

**VALUE**



ITBH 791 - RAPLAY

**Giftology** Raplay is a wireless earbud with quality bluetooth connection. Earbuds with microphone for handsfree calling. A frosted plastic case with a detachable USB Cable further adds to its amazing features.

Print Technique : UV, SC Preferred Print Location : Case Max Print Size : 55 x 20 mm  
Product Size : 10.5 x 3.4 x 2 cm Packing Details : 42 x 37 x 13.2 cm; 100 pcs/carton; gw/nw: 6 kg/carton

XDDESIGN®

**QUALITY**



Scan Below QR code to watch product video



MT 369 - JAM

XDDESIGN® In our current fast growing mobile world we want compact convenience. The Jam audio multitool delivers both needs with a smartphone/ iPod stand, headphone jack splitter, screen cleaner and cable wrap. All of these items are combined in this small, yet durable, audio tool to enhance your daily life. Registered design®  
 Print Technique : UV, SC Preferred Print Location : Front Max Print Size : 42 x 14 mm  
 Product Size : 8 x 2.2 x 1.8 cm Packing Details : 45.6 x 24.5 x 27 cm ; 200 pcs /carton ; gw/nw : 9 kg / carton

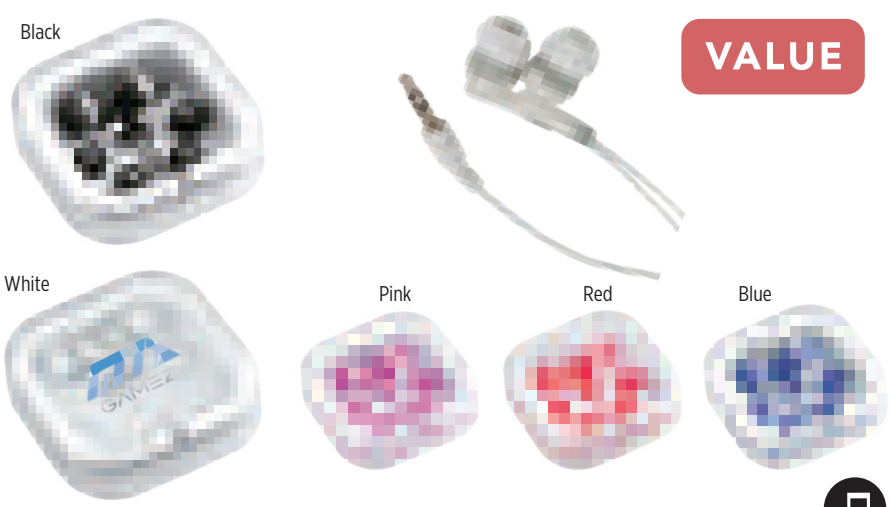

**VALUE**

READY STOCK

UTENA

ITMK 101 - Black ITMK 102 - White ITMK 103 - Blue ITMK 104 - Red ITMK 105 - Pink  
 Practical and comfortable earphones with a bicolored design, 3.5mm jack connection and matching color cable. Presented in an case and with spare pads.  
 Print Technique : UV, SC Preferred Print Location : Box Max Print Size : 40 X 40 mm  
 Product Size : 7 X 7 X 2 cm Packing Details : 32 X 43,5 X 46 cm ; 500 pcs / carton ; gw / nw : 15 kg / carton



- > Treated with Biomaster Antimicrobial Technology from UK
- > FSC Certified Bamboo
- > 3-in-1 PVC free Fashion Charging Cable

MTST 749 - ARANS

**MEMORI** Unique bamboo design 3-in-1 charging cable. The 15 cm cable is made from PVC free TPE material. USB Input and Type-C, Lightning and Micro USB Output. This product contains Biomaster antimicrobial technology that provides protection against the growth of harmful micro-organisms for the lifetime of the product. The bamboo used is FSC certified.  
 Print Technique : UV, SC, ENG Preferred Print Location : Front Max Print Size : 13 X 25 mm  
 Product Size : 17 X 2.2 X 1 cm



# MOBILE CHARGING CABLES

## Giftology



**3 in 1  
Micro USB  
Lightning  
Type - C  
Output**

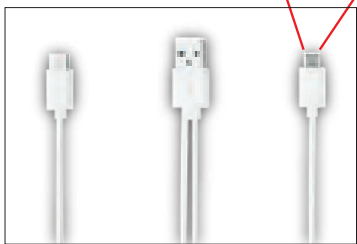

**MTST 702 - CABY**

Giftology Caby is a charging cable and a phone stand.

Print Technique : UV, SC Preferred Print Location : Case

Max Print Size : 55 x 55 mm Product Size : 7 x 7 x 1.8 cm

Packing Details : 50 x 39 x 17 cm; 200 pcs/carton; gw/nw: 9.5 kg/carton

## Giftology

> Stress-Relieving Fidget Spinner

> 3 In 1 Charging Cable

> Output : Lightning, Micro USB & Type-C

> Charges Device & Transfers Data

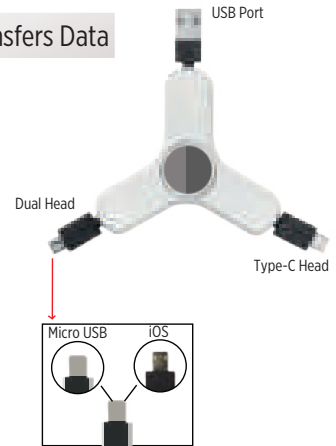

**MTST 701 - SPINCER**

Giftology Spincer is a playful fidget spinner & integrated charging cable that caters to almost all the smart devices. Spincer is a must-have accessory.

Print Technique : UV, SC, DOM Preferred Print Location : Center

Max Print Size : ø24 mm Product Size : 8.5 x 8.5 x 1.1 cm

Packing Details : 44 x 19.5 x 39 cm; 200 pcs/carton; gw/nw: 9.5 kg/carton

READY STOCK



Scan Below QR code to watch product video



## @MEMORII

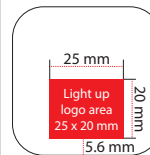

> Light-Up Logo When Engraved

> 750 mAh Emergency Powerbank for mobile phones with Micro USB Input

> Integrated 2 in 1 Lightning + Micro USB Cable

> Can Be Used For Charging And Data Transfer

Scan Below QR code to watch product video



**UD 795 - QUATRO**

XDDesign Quatro brings the 4 most common plugs into just one cable: Apple Lightning, Apple Dock, Micro USB and Mini USB. Now you can have them all together on a handy keychain so you'll never be without the right connector. Registered design®

Print Technique : SC, UV

Preferred Print Location : Front

Max Print Size : 25 x 25 mm

Product Size : 14.5 x 5 x 1 cm

Packing Details : 36 x 34 x 18 cm; 100 pcs/carton; gw/nw: 9.1 kg / carton

**ITPB 890 - Bray**

Print Technique : UV, SC, ENG Preferred Print Location : Front

Max Print Size : (Light-Up logo) 25 X 20 mm

Product Size : 5 x 5 x 1.5 cm

Packing Details : 26 x 30 x 32 cm; 240 pcs /carton;

gw/nw : 9.97 kg / carton



USB HUB + PHONE STAND

ITMK 122- BATAM

Desk phone holder with USB hub and light up logo and phone stand.  
 Print Technique : ENG Preferred Print Location : Front  
 Max Print Size : 50 X 10 mm Product Size : 7.6 X 3.4 X 6 cm  
 Packing Details : 33.5 X 38 X 35 cm ; 200 pcs / carton ; gw / nw : 10 kg / carton

XDDDESIGN®

USB HUB



ITXD 802 - FLAT HUB

XDDDESIGN® Flat Hub is a Hub with 3 USB 2.0 ports and one type C 2.0 port to charge devices efficiently and to transfer data. With integrated cable to attach it to the USB port of your computer flat hub caters to various devices to charge a device or to transfer data. Made out of aluminium and PP. Registered design®  
 Print Technique : UV, SC Preferred Print Location : Front  
 Max Print Size : 60 x 17 mm Product Size : 1.3 x 2.5 x 8.7 cm  
 Packing Details : 23 x 23 x 37 cm ; 200pcs /carton; gw/nw: 7.5 kg / carton

- > 3 USB 2.0 Ports With A Type-C Port
- > Charge Your Device Or Transfer Data
- > Integrated USB Cable

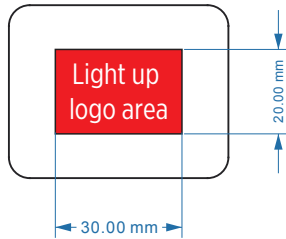

- > Light-Up Logo When Engraved
- > USB Hub with 4 USB 2.0 Outputs
- > Useful Desk Accessory!!

OPAVA

ITGL 791 - Black ITGL 793 - Blue

Giftology Opava is a USB hub with Micro USB input and 4 USB 2.0 outputs that extend the number of USB ports on your laptop or computer. This cable allows you to decorate the logo in a way that once connected it will light up for optimal brand exposure. Input : 5V/1A Output : 5V/1A.  
 Print Technique : UV, SC, ENG Preferred Print Location : Front  
 Max Print Size : Light up logo 30 x 20 mm Product Size : 5 X 4 x 1.10 cm  
 Packing Details : 75 X 33 X 16 cm; 400 pcs/carton; gw/nw: 19.6 kg/carton

Giftology



- > Mouse Pad
- > USB Hub
- > Excellent Branding Space

ITGL 815 - PITEA

Giftology Pitea is a multifunctional mouse pad with USB hub at the back. It has a Micro USB input and 3 USB 2.0 output. There is also a compartment to keep small items such as pins, eraser etc. (not included). Packed in a gift box.  
 Print Technique : UV, SC Preferred Print Location : Front  
 Max Print Size : 20 x 60 mm Product Size : 18 x 22 x 2 cm  
 Packing Details : 47 X 34.5 X 20.5 cm ; 50 pcs / carton ; gw / nw : 8.5 kg / carton

READY STOCK



# DESK TECH ACCESSORIES



### UD 735 - BREEZE

Expandable, USB powered laptop cooling fan that pushes a constant stream of cool air through your system, ensuring that it remains as cool as possible. Doubles as a Laptop Stand

Print Technique : UV, SC Preferred Print Location : Top Right Max Print Size : 30 x 20 mm  
Product Size : 22 x 9 x 2 cm Packing Details : 47.5 x 35.5 x 22 cm; 48 pcs/carton; gw/nw: 13.37 kg/carton

READY STOCK

## InnovativeAdapter IDAPT®



Comes with above 4 pin / tip system

### ED 447 - EZRA

IDAPT i2Pi is an innovative charging solution that eliminates cable clutter. IDAPT's patented interchangeable tip system allows you to safely charge almost any combination of portable devices quickly and easily. It is compatible with more than 5,000 electronic devices and combines style with simplified charging, perfect for today's mobile lifestyle.

Print Technique : SC Preferred Print Location : Front Bottom Center  
Print Size : 50 x 30 mm Product Size : 15.3 x 12.3 x 3.5 cm  
Packing Details : 58 x 39 x 33 cm; 24 pcs/carton; gw/nw: 14 kg/carton

### ED 448 A - DOCK

IDAPT i3P is an innovative charging solution that eliminates cable clutter. IDAPT's patented interchangeable tip system allows you to safely charge almost any combination of portable devices quickly and easily. It is compatible with more than 5,000 electronic devices and combines style with simplified charging, perfect for everyone's mobile lifestyle

Print Technique : SC Preferred Print Location : Front Bottom Right  
Max Print Size : 35 x 20 mm Product Size : 17x 13.5x 3.5 cm  
Packing Details : 58 x 39 x 33 cm; 24 pcs/carton; gw/nw: 14 kg/carton

IDAPT IS SUBJECT TO PATENTS AND REGISTERED TRADEMARKS.  
DEVICES ARE SHOWN FOR ILLUSTRATION PURPOSES ONLY AND ARE NOT INCLUDED.





ITPB 450 - POWERDO

Giftology This handy accessory features a 2200 mAh lithium ion Grade A non recycled battery, a USB output and a micro USB input with a cord included. It is compatible with most smartphones and has a telescopic handle with an activation button on the grip. No Bluetooth or remote needed, insert audio jack for power connection. Output: 5 Volts/1 Amp.

Max Print Size : 35 x 40 mm      Print Technique : SC, UV  
Preferred Print Location : Holder      Product Size : 24 x ø2.3 cm  
Packing Details : 37 X 21 X 28.5 cm; 50 pcs/carton; gw/nw: 10.5 kg/carton



360 degree free rotation  
Clip range: 57 - 80mm



Unique suction / Anti - slip bottom



ITSP 720 - KARON

Giftology Karon is a Bluetooth selfie stick with a 4000mAh power bank and 3 Watt speaker. The selfie stick is extendable up to 66 cm and has a 360 degree rotatable adjustment for your phone to take the perfect selfies. Its unique suction/anti slip bottom allows the selfie stick to stand without support. Input/output type: 5V / 2.1A

Max Print Size : 25 x 55 mm      Print Technique: UV, SC  
Preferred Print Location : Front      Product Size : 17.5 x ø5.10 cm  
Packing Details : 42.5X 35 X 26 cm; 40 pcs /carton; gw/nw: 14.7 kg/carton

READY STOCK

# BUDGET PROMOTIONAL TECH GADGETS

Giftology



Blue

White

BUMAB

ITTA 101- Blue ITTA 102 - White

Giftology Easy to use, portable and flexible USB fan. Can be used in the USB output of the computer but you can also create a mobile fan by inserting it in your power bank. Made out of high-grade silicone material.

Print Technique : UV Preferred Print Location : Front

Max Print Size : 20 x 8 mm Product Size : 14 x 8.5 x 1.4 cm

Packing Details : 56 x 36 x 29 cm; 357 pcs/carton; gw/nw: 14.2 kg/carton

Giftology

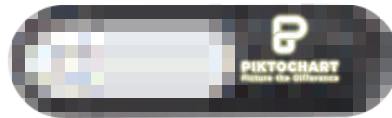
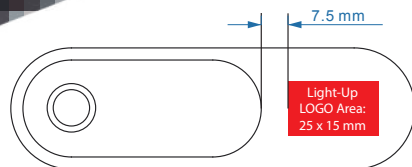

MTGL 402- KOLDING

Giftology Kolding is an ambient light that switches ON when it detects the presence of a person and switches OFF automatically when the person leaves the place. Strong magnets on the back allow Kolding to be firmly secured to metallic surfaces and 2-way tape allows Kolding to be secured to non-metallic surfaces. Light-Up logo possibility for optimal brand exposure.

Print Technique : UV, SC, ENG

Preferred Print Location : Front

Max Print Size : (Light-Up Logo) 25 x 15 mm Product Size : 11 x 3.5 x 1 cm

Packing Details : 24.5 x 18.5 x 23 cm; 100 pcs/carton; gw/nw: 4.2 kg/carton



DT 646 - LOMBL

Desktop Clock with Maze Game

Print Technique : UV, SC Preferred Print Location : Bottom

Max Print Size : 60 x 15 mm

Product Size : 8 x 10 x 4.3 cm

Packing Details : 38 x 28 x 35.7 cm

60 pcs /carton; gw/nw: 8 kg/carton

READY STOCK



- > Multipurpose Mobile Phone Holder
- > Secured & Strong Grip

**MTGL 301 - TORNIO**  
 @MEMORii Tornio is a multipurpose phone holder that can be used to secure your phone to the car air vent or your desktop/laptop. It provides secured grip to the phone on your hand and can be also used as a phone stand.  
 Print Technique : SC Preferred Print Location : Front  
 Max Print Size : 20 x 40 mm Product Size : 3 x 26 x 0.3 cm  
 Packing Details : 47 x 22.5 x 18.5 cm 150 pcs /carton; gw/nw: 6.5 kg/carton

Giftology



VR Glass, Vehicle Phone Stand & Earphone



**ITGL 104 - VIMINO**  
 Giftology Technology Set consisting of a VR glass for the ultimate virtual reality experience, a 360° rotating vehicle phone stand and an earphone. Packed in an elegant white pouch.  
 Print Technique : UV, SC Preferred Print Location : Pouch Top Center  
 Max Print Size : 70 x 150 mm Product Box Size : 22.5 x 15.5 x 4.5 cm  
 Packing Details : 49 x 34.5 x 51 cm; 40 pcs/carton; gw/nw: 13kg/carton

READY STOCK



- > 2200 mAh Powerbank
- > UV Coated Surface For Smooth Feel And Finish
- > Laser Pointer

Output Charging



Input Charging



**ITPB 420 - REY**  
 @MEMORii 2200 mAh powerbank in ABS casing with UV coating including laser pointer. Output 5V/1A, input 5V/800mAh.  
 Print Technique : SC,UV Preferred Print Location : Center Max Print Size : 45 x10 mm  
 Product Size : 9.5 x 3 x2 cm Packing Details : 49x 31 x 40.5 cm ; 80 pcs /carton ; gw/nw: 15.2 kg / carton



**XD Technology**



- > For Mobile Phones Up to 6"
- > Flat & Foldable
- > Adjustable Lenses

**ITXD 605 -THREDEE**

**XD Technology** Virtual reality glasses made out of ABS that can be folded flat to take anywhere you go. When unfolded your phone can be placed between two soft EVA cushions to keep the phone tight in the right position. Because of its clever design there is no need to take the phone out of the glasses to switch to another movie or game. Suitable for all mobile phones up to 6".

Print Technique : UV, SC Preferred Print Location : Front Max Print Size : 60 x 15 mm  
Product Size : 14.5 x 9 x 5.5 cm Packing Details : 51 x 33 x 34.5 cm ; 50 pcs/carton ; gw/nw : 9 kg/carton

READY STOCK

**@MEMORII**

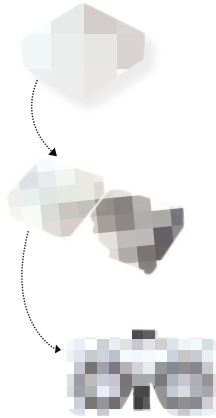

- > Works With Google Cardboard (Wgcc) Certified. This Certification Confirms That These Vr Glasses Works With Google Cardboard Apps & Games
- > Lenses Compatible With Google Card Board Ecosystem.
- > Super Compact When Folded And Comes In A Protective Slipcase
- > ios & Android Compatible

**ITVR 725 - POKKIT**

**@MEMORII** Pockit is a foldable VR glass with a carry case. It is WGCC Certified and compatible with all smartphones upto 6" . Its 34mm acrylic biconvex lens provides the ultimate VR experience !!

Print Technique : UV, SC Preferred Print Location : Front Max Print Size : 70 x 65 mm  
Product Size : 7.4 x 6.7 x 2 cm Packing Details : 53 x 30 x 39 cm ; 280 pcs/carton ; gw/nw ; 22 kg/carton

**XD Technology**



- > Shoot Your Own 3D Photographs And Movies
- > Suitable For Most Mobile Devices



**ITXD 701- Lens3D**

Universal 3D lens that is suitable for all common Android and iOS models. Simply place the clip on your mobile phone to make your own 3D photographs and movies. The lens is made out of ABS with PU pad to protect your phone.

Print Technique : UV, SC Preferred Print Location : Clip / Top Max Print Size : 45 x 15 mm  
Product Size : 3.8 x 6.7 x 2.5 cm Packing Details : 42 x 21 x 35 cm ; 100 pcs/carton ; gw/nw ; 4.5 kg/carton



Silver Black White



Webcam cover  
Protect  
Your  
Privacy !!



YOGYAKARTA

ITMK 111 -White ITMK 112 -Silver ITMK 113 -Black

Sliding cover for webcam camera to protect privacy.

Print Technique : UV, SC Preferred Print Location : Front

Max Print Size : 20 X 8 mm Product Size : 4.1 X 1.6 X 0.2 cm

Packing Details : 35 X 39.5 X 55.5 cm ; 10000pcs/carton ; gw/nw : 9.5 kg/carton



MEDAN

ITMK 109 - Red ITMK 110-Blue

Print Technique : UV, SC Preferred Print Location : Front

Max Print Size : 20 X 8 mm Product Size : 3.2 X 1.3 X 0.1 cm

Packing Details : 33 x 14 x 42.5 cm ; 10000 pcs/carton ; gw/nw : 4.5 kg/carton



Red Blue

READY STOCK



Take  
Great  
Pics !!



DEPOK

ITMK 125 - Black ITMK 126 - Silver

Original 4-in-1 universal lens system for smartphone. Without the need to exchange lenses, it offers macro, CPL, fisheye and wide-angle modes. With safety clamp.

Print Technique : SC Preferred Print Location : Front

Max Print Size : 30 X 10 mm Product Box Size : 9.1 X 2.8 X 6.8 cm

Packing Details : 58 X 36 X 62 cm ; 200 pcs / carton ; gw / nw : 15kg / carton



ITMK 124 - BOGOR

Set of 3 universal lenses for smartphone, adjustable to the camera by means of a clip. Aluminum and glass lenses, with fish eye, macro and wide angle effects. With microfibre cleaning cloth and presented in a velvet bag with self-closing laces. Set presented in an attractive design box.

Print Technique : SC Preferred Print Location : Clip

Max Print Size : 40 X 30 mm Product Size : 15 x 7 mm

Packing Details : 31.5 X 29 X 49 cm ; 100 pcs / carton ; gw / nw : 5kg / carton





Keyfetch the only online lost property service to connect owners and finders directly and anonymously, at a click.



*Socially Responsible Gift*



## Tag Anything!

Keys, Cards, Bags, Phones, Laptops...



## BENEFITS

- Allows customers / employees to protect their valuables and allows you to advertise your brand at the same time
- Promote your brand by putting your logo on millions of your customers everyday belongings, visible 24/7, 365 days a year.
- Be part of solving a real life problem
- Nurture your socially responsible corporate image.
- Works globally

## FEATURES

- Directly and anonymously connects owners and finders of lost items
- 100% anonymous patented messaging system
- Private label offering designed to put your logo on millions of everyday items



Keyfetch is the only service of its kind to have received an official accreditation from the UK Association of Chief Police Officers (ACPO) as part of the Secured by Design nationwide initiative.

[www.keyfetch.com](http://www.keyfetch.com)



# How It Works!

**1**

**3**

**2** Instant notification to the owner. "Click to Chat"

**4**

READY STOCK



**MSKF 101- Keyfetch**

**KEYFETCH** is a smart keychain that allows the owner of the keychain to find his/ her lost keychain by connecting the owner & the finder anonymously.

Print Technique.: UV, SC, ENG

Preferred Print Location: (Box) Front

Max Print Size: ø 32 mm

Product Size: ø3.2 cm

Packing Details : 30 x 28 x 18 cm ; 1000 pcs /carton ; gw/nw: 8.3 kg / carton



Scan Below QR code to watch Brand video

SAFE + SIMPLE + SWISS

### SKROSS® – Swiss innovation

SKROSS® invented and patented the first all-in-one world adapter with country slider system in 2002. The World Adapter Classic promptly became a worldwide bestseller. Exports to over 60 countries confirmed that high-quality, multifunctional travel adapters that are both safe and compact attract tremendous international interest. The company is the global market leader for high-quality travel adapters.

### Using international standards as the basis for product development

At SKROSS®, **safety** is always at the centre of the entire development and production process. The standards defined by the International Electrotechnical Commission (IEC) form the foundation for the development team to design innovative gadgets that give you access to power anywhere in the world. Extensive quality controls accompany every production phase, with final certification processes documenting each product's compliance with IEC standards.

### Simple charging – any time

With SKROSS®, staying fully charged is simple – anywhere around the world, on all continents. The patented country slider system ensures connection in over 150 countries. At the same time, SKROSS® products remain the most compact and easy to use on the market. That is what makes SKROSS® unique. And this has already impressed not just millions of travellers, but many judging panels as well. SKROSS® products have won numerous Red Dot Design Awards and Product of the Year accolades, recognising both their functionality as well as their design.

### SKROSS® – a global player from Switzerland

Today, SKROSS® operates in over 100 countries around the world, successfully positioning itself as the market leader in the field of high-quality travel accessories. Our products are available from duty-free shops in all major airports around the world, from the in-flight shops of all the leading airlines and from private retail outlets.





reddot design award winner



- Designed In Switzerland
- Suitable For All 2-pole (Unearthed) Devices
- Receptacles For: Euro, USA/Japan, Australia/China, UK
- Retractable Plugs : Euro, USA/Japan, Australia/China, UK
- Input Voltage : 100v – 250v ; Max. Load: 2.5a
- Power Rating : E.G. 100v – 250w / 250v – 625w
- Integrated Fuse : T2.5a

Compatibility Input

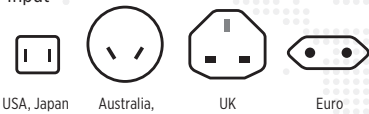

Output

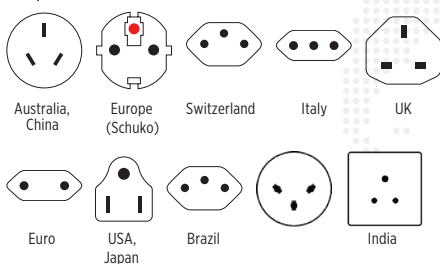

Scan Below QR code to watch product video



**TASK 102 - SKROSS WORLD ADAPTER MUV MICRO**

**SKROSS** The World Adapter MUV Micro from SKROSS is the most compact 2-pole travel adapter for travellers from all over the world. The patented country slider system guarantees simple and safe connection in over 150 countries on all continents – irrespective of the socket standard.

Product Size: 5.4 x 5 x 5.3 cms

Packing Details: 30 X 38 X 15 cm ; 50 pcs / carton ; gw / nw : 6.63 kg / carton

- Designed In Switzerland
- Suitable For Equipment With 2- & 3-Pole Plugs
- Input Voltage : 100 V – 250 V
- Max. Load : 6.3 A
- Power Rating : E.G. 100 V – 630 W / 250 V – 1575 W
- Integrated Fuse : T6.3 A
- USB Output : 5 V / 2400 Ma Shared

Compatibility Input

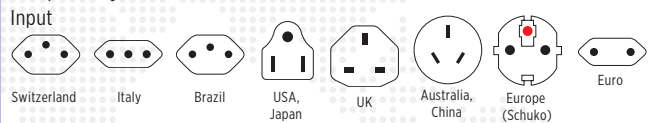

Output

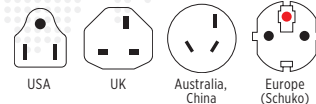

Scan Below QR code to watch product video



**TASK 104 - SKROSS PRO LIGHT USB WORLD**

**SKROSS** The PRO Light USB – World, the smallest 3-Pole world travel adapter with an integrated USB charger, ensures a simple and safe connection of 2- and 3-pole devices from and to more than 200 countries (thanks to the included World to Europe top). The available power of up to 1575 W makes it unique in its application even with powerful devices like laptops or hairdryers. Wherever the traveller comes from, the World Adapter PRO Light USB – World provides the safest solution of plugging in devices around the world. Furthermore the dual USB port provides sufficient energy to charge two USB devices easily, even if another device is connected via the adapter at the same time.

Product Size : 7 x 5.8 x 6.7 cms

Packing Details : 34.5 X 41 X 38.5 cm ; 50 pcs / carton ; gw / nw : 8.25 kg / carton

**READY STOCK**



READY STOCK



Scan Below QR code to watch product video



- > World Travel Adapter With 5000 mAh Powerbank
- > Includes US/EU/UK/AUS Plugs
- > High Density Li-Polymer Battery
- > Travel Adapter With 2 USB Outputs



**ITTA 210 - DERRY**

@MEMORII Derry is a Universal World Travel Adapter with a detachable 5000mAh Powerbank. The adapter has 2 USB outputs to charge 2 devices simultaneously & is compatible with over 150 countries with US/EU/UK/AUS plugs. Just push the knob of the plug you want to charge & your device will charge safely in almost any part of the world. Attached to the Universal travel adapter is a 5000mAh detachable Powerbank which is equipped with high density Li-Polymer battery that safely charges almost any of your electronic devices very quickly. Input /Output : 5V/2A.

Print Technique : UV Preferred Print Location : Front  
 Max Print Size : 70 X 40 mm Product Size : 9 x 5.5 x 5.5 cm  
 Packing Details : 61.7 x 23.7 x 8.1 cm ; 14pc /carton; gw/nw: 4.90 kg / carton

Scan Below QR code to watch product video



- > World Travel Adapter With 10W Fast Wireless Charger
- > Includes US/EU/UK/AUS Plugs
- > Overcharge Protection, Over Current Protection
- > Over Voltage Protection And Foreign Object Detection



**ITTA 211 - NEWRY**

@MEMORII Newry is a Universal World Travel Adapter with a 10W fast-charging Wireless charger. The adapter has 2 USB outputs to charge 2 devices simultaneously & is compatible with over 150 countries with US/EU/UK/AUS plugs. Just push the knob of the plug you want to charge & your device will charge safely in almost any part of the world. The accompanied 10W wireless charger enables you to charge your phone by just placing it on the charger. Experience fast-charging with 10W Wireless charger which has the capacity to charge an iPhone 8 in just 2.5 hrs. Compatible with all Qi enabled devices like Android latest generation, iPhone 8, 8S & X. Input /Output : 5V/2A.

Print Technique : UV Preferred Print Location : Front  
 Max Print Size : 70 X 40 mm Product Size : 8.7 x 5.4 x 5 cm  
 Packing Details : 35.9 x 23.7 x 14.2 cm ; 16pcs /carton; gw/nw: 4.90 kg / carton

Plugs for over 150 countries including US, UK, EU, AUS



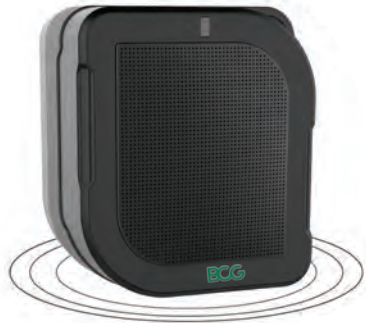

- > 3 Watt Bluetooth Speaker
- > Made From Fire Retardant Pc Materials
- > Included Rechargeable connectors for UK, EU, USA and AUS/NZ plugs

**ITTA 161 - VALGA**

@MEMORii Valga is a wall charger with 3000mah powerbank and 3 Watt bluetooth speaker. Consists of rechargeable connectors for UK, EU, USA and AUS/NZ plugs. Made from fire retardant PC materials. Packed in a gift box.

Print Technique : UV, SC Preferred Print Location : Front Bottom / Side Max Print Size : (Bottom) 8x20mm (Side) 40x10mm  
 Product Size : 83 x 72 x 45cms Packing Details : 61.7 x 23.7 x 8.1 cms; 18pc /carton; gw/nw: 4.90 kg / carton

READY STOCK

**SANTHOME**

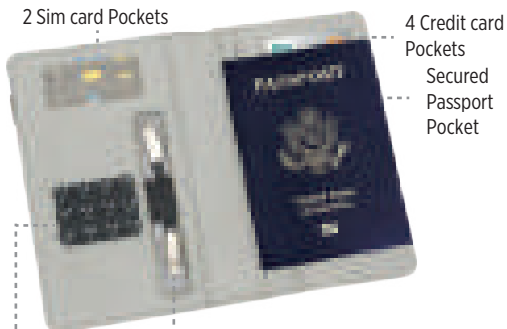

Suction Cups to hold your phone  
 Lightning and Micro USB Output

- > 4000 mAh Powerbank
- > 8 GB USB
- > Integrated Connectors



**ITTA 205 - KRIM**

SANTHOME Krim is a Passport holder with 4000mAh powerbank and 8 GB USB. The input charging of the powerbank is with an included cable that has a micro USB input and micro + lightning USB output. A display LCD screen shows the available power. Practical pockets on the inside and outside make it a convenient and useful travel accessory.

Print Technique : SC, ENG Preferred Print Location : Front  
 Product Box Size : 10.5 x 16.5 x 2 cm Max Print Size : 80 x 40mm  
 Packing Details : 51 x 39 x 20 cm ; 60 pcs /carton ; gw/nw: 14.4 kg / carton



- > Weight Mode : Kg/lb
- > Weight Range : 300 Gms - 40 Kgs
- > Tare Function And Data Lock
- > Overload Indicator

**ITTA 301 - FANO**

Giftology Digital luggage scale with max capacity of 40kg, division 100g, kg/lb mode, zero and tare function, low battery and overload function.

Print Technique : SC, UV Preferred Print Location : Front  
 Max Print Size : 20 x 15 mm Product Size : 11.7 X 3.9 X 2.70 cm  
 Packing Details : 31.5 x 25.5 x 27.5 cm; 60 pcs/carton; gw/nw: 4.6 kg/carton



## TRAVEL ACCESSORIES



SANTHOME

- > Set Consisting Of Neck Pillow & Eye Mask
- > Foldable Design For Easy & Compact Carry
- > Comfort Lifestyle Product



TASN 101- ZABARI

SANTHOME Prevent neck, shoulder and head complaints with this microbead neck pillow. The U-shape of this super soft neck pillow guarantees optimal support for your neck, shoulders and head during long or short trips. Also included is an eye mask for a good sleep. Neck Pillow & Eye Mask fold inside a compact, easy to carry pouch.

Print Technique : SC, UV Preferred Print Location : Pouch Max Print Size : 70 x 90 mm  
Product Size : 15 x ø16 cm Packing Details : 34 x 46 x 45 cm ; 24 pcs /carton ; gw/nw: 8.9 kg / carton

READY STOCK



SWISS PEAK®



Designed by:



Ryan McSorley  
Ireland

TA 120 - ALPINE

SWISS PEAK® 1680D zippered travel wallet with metal Swiss Peak logo on the front. All pockets required for a comfortable and practical journey are present there. Furthermore integrated cord allows easy hanging of the wallet around your neck. Registered Design®

Print Technique : SC, ENG Preferred Print Location : Center Max Print Size : 60 x 60mm  
Product Size : 14.5 x 16.5 x 3 cm Packing Details : 35 x 30.5 x 41 cm ; 50 pcs /carton ; gw/nw: 13.5 kg / carton



  
Pierre Cardin  
PARIS

### FEATURES :

- > PIERRE CARDIN luggage tag
- > silver PIERRE CARDIN logo
- > long lasting leather strap

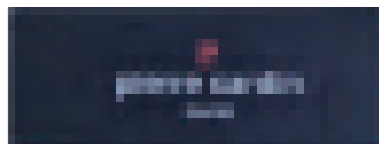

TAPC 785 - BOULONGE

Print Technique : UV, ENG Preferred Print Location : Back Max Print Size : 15 X 30 mm  
Product Size : 3.6 X 9.5 X 0.5 cm Packing Details : 71.5 X 20 X 18 cm ; 164 pcs / carton ; gw / nw : 9.6 kg / carton



- UV-C Kills 99.9% bacteria
- 2 different zippered compartments, for UV-C & for holding travel & daily accessories
- Sterilise on - the - go
- Use your own powerbank / power source or check with us for our range of powerbanks ( Pages 94 to 100 )
- Non - Toxic; Without Mercury

READY STOCK



**ITSN 104 - HABRY**

SANTHOME  
PROTECT  
Everyday use pouch that keeps your daily articles SAFE and HYGIENIC. This pouch has a special compartment with UV-C light that kills 99.9% bacteria on the item kept in the compartment. This UV-C compartment can help you with sterilizing your currency, passport, boarding pass, phone etc that are generally prone to multiple contact with bacterial surfaces by just connecting a cable provided on the back pocket to a power source such as laptop or powerbank. Another zipper compartment features- a zipper pocket for keys, currency, coins etc., pocket to hold multiple passports and has space for your everyday electronic accessories. Packed in a Santhome gift box.

Print Technique : SC, HT  
Product Size : 21.5 X 13 X 4.5 cm

Preferred Print Location : Front Bottom

Max Print Size : 75 X 70 mm

Packing Details : 45.7x 31.5 x 48.4 cm ; 28 pcs / carton ; gw / nw : 13.2/14.2 kg / carton



READY STOCK



RFID BLOCKING



- RFID Safe
- Lightweight & Ultrathin Material
- Passport Holder + Wallet Set



GSXD 101 - QUEBEC SET

XD<sup>X</sup>CLUSIVE® This set consists of lightweight and secure RFID safe bi-fold wallet and passport holder. The RFID-blocking material protects against identity theft & electronic pick pocketing. Registered design®

(Passport Holder) Print Technique : SC, EMB, ENG  
(Wallet ) Print Technique : SC, EMB, ENG  
Product Box Size : 22 X 2 X 16.8 cm

Preferred Print Location : Front      Max Print Size : 70 x 60 mm  
Preferred Print Location : Front      Max Print Size : 80x 40 mm  
Packing Details : 41 x 36 x 14cm ; 80pcs /carton; gw/nw: 4.2 kg / carton



- > RFID Safe
- > Ultrathin & Lightweight Material

- > RFID Safe
- > Ultrathin & Lightweight Material

READY STOCK



**TAXD 101 - QUEBEC PASSPORT HOLDER**

XDXCLUSIVE® This ultra-thin, lightweight and secure RFID safe passport holder is a unique design for travelling. The RFID-blocking material protects against identity theft and electronic pickpocketing. 3 easy access card slots can hold up to 6 cards. Registered design®

Print Technique : SC, EMB, ENG Preferred Print Location : Front  
 Product Size : 14.5 x 10 x 0.4 cm Max Print Size : 70 x 40 mm  
 Packing Details : 41 x 36 x 14cm ; 80 pcs /carton ; gw/nw: 4.2 kg / carton

**MAXD 101 - QUEBEC WALLET**

XDXCLUSIVE® This ultra-thin, lightweight and secure RFID safe bi-fold wallet has a unique design that suits everyone. The RFID-blocking material protects against identity theft and electronic pickpocketing. 4 easy access card slots can hold up to 10 cards. Registered design®

Print Technique : SC, EMB, ENG Preferred Print Location : Front  
 Product Size : 11.6 x 8.5 x 0.6 cm Max Print Size : 80 x 40 mm  
 Packing Details : 48 x 36 x 17 cm ; 80 pcs /carton ; gw/nw: 5.72 kg / carton



# TRAVEL ACCESSORIES

**XDDDESIGN®**  
GENUINE LEATHER



Boarding Pass Pocket



Mobile Phone Pocket



Passport+ Credit card+ Currency Pockets



6311 - KOMO Travel Wallet

XDDDESIGN® The Komo leather travel wallet raises your travel experiences to the next level. The combination of leather and stylish fabric makes the item luxurious and durable. The inside provides space for all necessities and the zipper closure provides extra safety, making your boarding experience a breeze. Registered design®

Print Technique : ENG, SC, EMB Preferred Print Location : Front  
Max Print Size : 90 x 120 mm Product Size : 10.5 x 23 x 2.0 cm  
Packing Details : 42 x 27 x 25.5 cm ; 15 pcs /carton ; gw/nw: 5.7 kg / carton

**XDDDESIGN®**  
GENUINE LEATHER



Boarding Pass Pocket



Mobile Phone Pocket



Passport Pocket



6312 - KOMO Passport Holder

XDDDESIGN® The Komo leather passport holder raises your travel experiences to the next level. The combination of leather and stylish fabric makes the item luxurious and durable. The inside provides space for all necessities making your boarding experience a breeze. Registered design®

Print Technique : SC, EMB Preferred Print Location : Front  
Max Print Size : 120 x 80 mm Product Size : 11 x 15 x 2 cm  
Packing Details : 56 x 30.5 x 25.5 cm ; 35 pcs /carton ; gw/nw: 9.3 kg / carton

READY STOCK

## Giftology



Packed in a Cotton Pouch



- > Genuine Leather
- > Toiletries Pouch / Wash bag for organizing your travel
- > Zipper Pockets in front, at the back & on top
- > Spacious interior

LAGL 019 - GUBEN

Giftology Each leather wash bag in an elegant natural cotton drawstring pouch.

Print Technique : FO, EMB, SC Preferred Print Location : Front Max Print Size : 40 X 50 mm  
Product size : 25 X 10 X 13 cm





- > High end - Sustainable Travel accessory
- > Made from GRS-Certified Recycled Fabric
- > This Bag saved 10 litres of water
- > This Bag is made by recycling 4 plastic bottles

**-10L**    
**4**

HPSN 551 - TRIKOMO

SANTHOME CHANGE Wash Bag / Toiletries Pouch - made with high-end durable 1680D recycled rPET (certified by GRS) and stylish leather components. Get your essentials organized while supporting Water.org to provide safe water to people in need with each purchase. Each bag saves 10L of water and reuses 4 plastic bottles

Print Technique : SC Preferred Print Location : Front Max Print Size : 110 x 50 mm  
Product size : 23 X 14 X 10.5 cm

**SAY NO TO GREENWASHING**

*Tell the true story of sustainability with genuine recycled rPET*

Certified by





**GIFTS THAT GIVE BACK**

- 785 million people - 1 in 9 - lack access to safe water. We are supporting Water.org to change this.
- For each CHANGE bag sold, 3% of sales is donated by brand owners to Water.org to save lives with safe water and sanitation.



READY STOCK

**-9L**    
**4**

- > High end - Sustainable Travel accessory
- > Made from GRS-Certified Recycled Fabric
- > This Bag saved 9 litres of water
- > This Bag is made by recycling 4 plastic bottles



HPSN 552 - POMOS

SANTHOME CHANGE Technology Accessories Kit - made with high-end durable 1680D recycled rPET (certified by GRS) and stylish leather components. Organizes all tech accessories (like cables, chargers, power banks, adapters, etc.). Great for office or travel. Each bag saves 9L of water and reuses 4 plastic bottles, while supporting Water.org to provide safe water to people in need with each purchase.

Print Technique : SC Preferred Print Location : Front Max Print Size : 120 x 100 mm  
Product size : 27 X 16 X 7 cm



# PREMIUM CABIN TROLLEY & TRAVEL GARMENT BAG

## SANTHOME

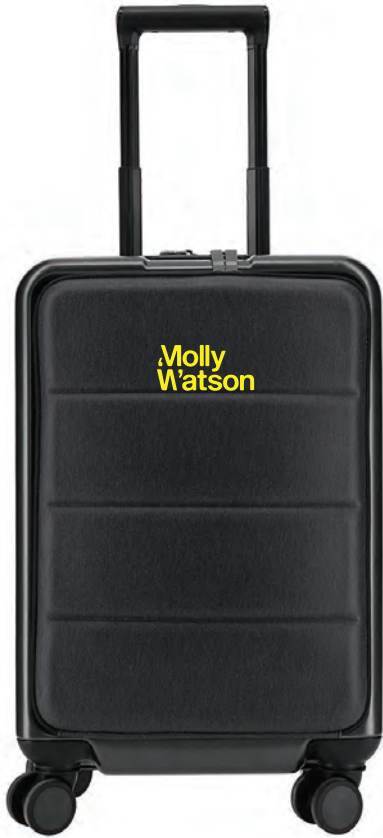

TSA Lock For Compartments



Quick Access Front Pocket



Scan Below QR code to watch product video



- > 20" Cabin Trolley With 17" Laptop Compartment
- > External USB Charging Port
- > Twin TSA Lock For Both Main Compartment & Front Pocket
- > Quick Access Front Pocket
- > Sturdy Double Spin Wheels

READY STOCK

### TBSN 104- CASHEL

SANTHOME Cashel is a 20" Overnighter trolley bag with Iron Trolley System, Double Spin wheels, Dual TSA lock (one for main compartment and second for the front pocket), USB external charging port on the outside and a laptop compartment. Now go on your business trips in style and comfort with this lavish looking trolley bag.

Print Technique : SC

Preferred Print Location : Front flap

Max Print Size : 100 X 40 mm

Product Size : 55 X 35 X 23.50 cm

Packing Details : 57.5 x 37 x 23 cm ; 1 pcs /carton ; gw/nw: 3.66 kg / carton



by Conino Lamborghini



### MARTONE -98185

Conino Lamborghini An easier way to arrive fresh and pressed. Lightweight and fully stocked with multiple organizational features, this garment bag uses a locking hanger clamp system that keeps clothes wrinkle free and is built with handles that fasten together for even easier carrier.

Print Technique : SC, HT

Preferred Print Location : Front

Max Print Size: 100 x 30 mm

Product Size : 52 x 38 x 16 cm

Packing Details : 57.2 x 40.3 x 57.8 cm ; 6 pcs /carton ; gw/nw: 12.8 kg / carton



- > 17" Laptop Compartment
- > Well Balanced 4 Wheel Trolley System
- > Perfect For Overnight Business Trips

**TBSN 103 - LAPOVO**

**SANTHOME** All your documents will pack securely in this business trolley. Papers and laptop(upto 17") can be neatly placed in one of the compartments, some of which can be locked. Also a perfect trolley for short business trips. With 4 wheel trolley system for stability on your way.

Print Technique : SC, HT  
Product Size : 44 x 43 x 23 cm

Preferred Print Location : Front flap  
Max Print Size : 30 x 100 mm  
Packing Details : 60 X 44 X 43.5 cm ; 3 pcs / carton ; gw / nw : 9.4 kg / carton

**READY STOCK**



Santhome Zipper Pullers



**TBSN 101 - CARYONN**

**SANTHOME** 17", 4 wheel Trolley bag made from high quality and durable, dual tone cationic fabric. The luggage is designed to fit in most airlines overhead compartments. Foam center garment panels gently blanket clothes to minimize wrinkling. Compact, rugged and exceptionally manoeuvrable, this trolley has multiple exterior pockets to keep boarding passes, magazines and a water bottle close at hand. Four 360° spinner wheels and a three-stage aluminum handle let you glide through the airport and down the aisle without a hitch.

Print Technique : SC, HT  
Product Size : 43 x 36 x 20 cm

Preferred Print Location : Front Top  
Max Print Size : 100 x 30 mm  
Packing Details : 72 x 43 x 40.5 cm ; 3 pcs / carton ; gw / nw : 11 kg / carton



**IMPACT**

AWARE™ RPET WEEKEND  
DUFFLE BAG

**XDDESIGN®**

**SAY NO TO GREENWASHING**

*Tell the true story of sustainability with genuine recycled rPET and cotton with validated claims.*

Certified by Global Recycled Standard

**GIFTS THAT GIVE BACK**

785 million people - 1 in 9 - lack access to safe water. We are supporting Water.org to change this.

For each IMPACT bag sold, **2% of sales is donated** by the Xindao B.V. (Netherlands) to Water.org to save lives with safe water and sanitation.



**READY STOCK**

- 2% of proceeds of each product committed to Water.org
- This bag is made of 45 recycled bottles
- Made with AWARE™ tracer
- This bag saved 27 liters of water

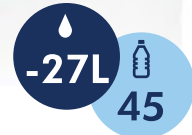

**DBAW 457 - DUFFLE BAG**

**XDDESIGN®** No greenwashing, but telling a true story about sustainability! This Impact collection is made with AWARE™ tracer. With AWARE™, the use of genuine recycled fabric materials and water reduction impact claims are guaranteed, by using the AWARE disruptive physical tracer and blockchain technology. Save water and use genuine recycled fabrics. If you choose this item you save 27 litres of water and 45 plastic bottles have been reused. With the focus on water, 2% of proceeds of each Impact product sold is donated to Water.org. The AWARE™ weekend duffle impresses with its modern and simple look. Its clean design makes the duffle ideal for travel. The roomy main compartment offers plenty of space for your essentials. Two mesh pockets make your smaller items easy to find. The front zipper pockets have 2 sleeve pockets and 2 pen loops. Interior and exterior 100% recycled polyester with AWARE™ tracer. PVC free.

Print Technique : SC

Preferred Print Location : Front

Max Print Size : 250 x 35 mm

Product Size : 32 x 22 x 55 cm

Packing Details : 43 X 36 X 59 cms ; 15 pcs / carton ; gw / nw : 11.5 kg / carton



- > Made from Recycled PET fabric certified by Global Recycled Standards
- > 3% of sales proceeds of each product is committed to Water.org
- > High-end Sustainable
- > This bag saved 43 liters of water
- > This bag is made by recycling 17 plastic bottles

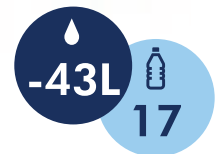

**GO directly to office from gym -  
Go directly to gym from office**

**AN EXECUTIVE  
Duffel Bag**

**SAY NO TO GREENWASHING**

*Tell the true story of sustainability with genuine recycled rPET*

**Certified by**



**GIFTS THAT GIVE BACK**

785 million people - 1 in 9 - lack access to safe water. We are supporting Water.org to change this.

For each CHANGE bag sold, 3% of sales is donated by brand owners to Water.org to save lives with safe water and sanitation.



**READY STOCK**



**DBSN 661 - PEGEIA**

SANTHOME CHANGE Duffel / Weekender / Gym Bag made from high-end durable 1680D recycled rPET (certified by GRS) and stylish leather components. Includes special shoe compartment. Each bag saves 43L of water and reuses 17 plastic bottles, while supporting Water.org to provide safe water to people in need with each purchase.

Print Technique : SC, HT

Preferred Print Location : Pocket

Max Print Size : 100 X 200 mm

Product size : 54 x 26 x 25 cm



- > Made from Recycled PET fabric certified by Global Recycled Standards
- > 3% of sales proceeds of each product is committed to Water.org
- > This bag saved 35 liters of water
- > This Bag is made by recycling 14 plastic bottles
- > Expandable zipper adds additional storage
- > Back trolley strap to attach backpack to trolley bag

READY STOCK



**SAY NO TO GREENWASHING**

*Tell the true story of sustainability with genuine recycled rPET*

Certified by



**GIFTS THAT GIVE BACK**

- 💧 785 million people - 1 in 9 - lack access to safe water. We are supporting Water.org to change this.
- 💧 For each CHANGE bag sold, **3% of sales is donated** by the brand owner to Water.org to save lives with safe water and sanitation.



Takes in a lot of stuff



Trolley Strap for attaching to trolley bag

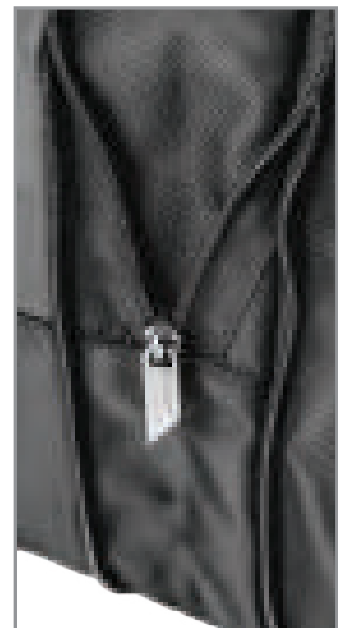

Expandable Zipper

**BPSN 796 - MARGO**

**SANTHOME** CHANGE Laptop Backpack made from high-end durable 1680 recycled rPET (certified by GRS) and stylish leather components. Elegant executive design. Extra zipper provided expandable storage space. Each bag saves 35L of water and reuses 14 plastic bottles, while supporting Water.org to provide safe water to people in need with each purchase.

Print Technique : SC

Preferred Print Location : Front Top & Bottom

Max Print Size : 100 X 130 mm

Product size : 44 x 30 x 13 cm (Expanded) 44 x 30 x 17 cm

Packing Details : 69 x 60 x 49 cm ; 6 pcs /carton ; gw/nw: 10.9 kg/ carton



READY STOCK

- > 2% of proceeds of each product donated to Water.org
- > This bag is made of 33 recycled bottles
- > Made with AWARE™ tracer
- > This bag saved 19 liters of water

-19L 33

**SAY NO TO GREENWASHING**

**Tell the true story of sustainability with genuine recycled rPET and cotton with validated claims.**

Certified by

**GIFTS THAT GIVE BACK**

- 💧 785 million people - 1 in 9 - lack access to safe water. We are supporting Water.org to change this.
- 💧 For each IMPACT bag sold, 2% of sales is donated by the Xindao B.V. (Netherlands) to Water.org to save lives with safe water and sanitation.

**IMPACT**

BGAW 458 - Black    BGAW 459 - Anthracite    BGAW 460 - Navy Blue

**XD COLLECTION** No greenwashing, but telling a true story about sustainability! This Impact collection is made with AWARE™ tracer. With AWARE™, the use of genuine recycled fabric materials and water reduction impact claims are guaranteed, by using the AWARE disruptive physical tracer and blockchain technology. Save water and use genuine recycled fabrics. If you choose this item you save 19 litres of water and 33 plastic bottles have been reused. With the focus on water, 2% of proceeds of each Impact product sold has been donated to Water.org. The streamlined AWARE™ 15.6" laptop backpack includes a laptop sleeve in the main compartment and an inside sleeve pocket with 2 pen loops. A separate front zipper pocket can hold your small daily essentials. Interior and exterior 100% recycled polyester with AWARE™ tracer . PVC free.

Print Technique : SC                      Preferred Print Location : Front                      Max Print Size: 180 X 40 mm  
 Product Size : 44.5 X 12 X 30.5 cm                      Packing Details : 49.5 X 38.5 X 48.5 cm ; 12 pcs / carton ; gw / nw : 5.5 kg / carton



READY STOCK



- > Key hanger
- > 15.6" Laptop compartment
- > Quick access pocket
- > Smart Sleeve
- > Material: 100% Polyester
- > Warranty: Limited 2 year global warranty



BPSAM 473 - LERMA

Sams<sup>o</sup>nite TECH-ICT takes inspiration from the world of technological gadgets and apparel in order to deliver a high-tech and lightweight design with smart organization and features to the value conscious customer. The line incorporates core functionality in a sleek exterior made of polyester mix, together with a contrasting color details.

Print Technique : SC

Preferred Print Location : Front

Max Print Size : 150 X 150 mm





# THE BOBBY SLING BAG

Made from (rPET)  
Recycled PET Bottles



Made from genuine recycled fabric  
All IMPACT claims verified using AWARE disruptive physical tracer & Blockchain technology

## IMPACT

THIS BAG IS MADE OF 20 RECYCLED WATER BOTTLES

THIS BAG SAVED 12L WATER

785 million people — 1 in 9 — lack access to safe water

We are supporting Water.org to change this.

For each product sold we have donated 2% of proceeds to support Water.org to change lives with safe water.

Xindao B.V.  
The Netherlands

For more info visit:  
[www.theimpactcollection.org](http://www.theimpactcollection.org)



READY STOCK



BGXD 691 - BOBBY SLING

**XDDESIGN** Safe, comfortable and smart, the Bobby Sling was designed for the city travellers. Feel protected with the famous Bobby anti-theft features like hidden zippers, no front access, RFID protected pocket and cut resistant material, also a 3 point safe buckle will make sure that your daily essentials are always along your body. Additional features like water-resistant material and integrated USB charging port makes this crossbody backpack the most convenient option for your everyday journey. Made from R-pet materials and AWARE™ tracer. With AWARE™, the use of genuine recycled fabric materials and water reduction impact claims are guaranteed, by using the AWARE disruptive physical tracer and blockchain technology. Each Bobby Sling saves 12 litres of water and reuses 20 plastic bottles. Registered design®

Print Technique: SC Preferred Print Location : Front Max Print Size : 120 X 120 mm  
Product size : 32.5 x 9 x 21 cm Packing Details : 38 x 51 x 53.5 cm ; 8 pcs /carton ; gw/nw: 7.5 kg/ carton

# REDUCING THE USE OF WATER

BY USING TRACEABLE AND CERTIFIED RECYCLED MATERIALS WE  
SAVE HUGE AMOUNTS OF WATER

## EACH XD DESIGN SUSTAINABLE BACKPACK:

### REUSE

AN AVERAGE OF

# 31

### WATER BOTTLES



### SAVED

AN AVERAGE OF

# 18

### LITRES OF WATER

Bobby + Recycled PET  
= **BOBBY HERO**  
Anti - Theft Backpack  
(The ORIGINAL just got better)





Red



Black



Green



Grey



Navy Blue

Made from (rPET)  
Recycled PET Bottles

Scan Below QR  
code to watch  
product video



Light Blue

- Each bag is made of 27 plastic bottles
- Each bag saves 16 liters of water
- Made with AWARE™ tracer

READY STOCK



BOBBY HERO

BGXD 625 - Black    BGXD 626 - Grey    BGXD 627 - Navy Blue    BGXD 628 - Red    BGXD 629 - Green    BGXD 630 - Light Blue

XDDESIGN® The Bobby Hero line is our new generation of anti-theft backpacks. This new model will help you to move safely, carefree and organised. Key features such as cut-proof protection, hidden zipper closures & pockets will keep your belongings safe during your commutes. Bobby is also the most convenient backpack with features such as an integrated USB charging port, water-repellent fabric, illuminating safety strips and a luggage strap. On the inside there are padded compartments for a 15.6" laptop, tablet up to 12.9" and all your other belongings. Made from R-pet materials and AWARE™ tracer. With AWARE™, the use of genuine recycled fabric materials and water reduction impact claims are guaranteed, by using the AWARE disruptive physical tracer and blockchain technology. Each Bobby Hero regular saves 16 litres of water and reuses 27 plastic bottles. Registered design®

Print Technique : SC

Preferred Print Location : Front

Max Print Size : 150 X 150 mm

Product size : 45 x 16 x 29 cm

Packing Details : 69 x 60 x 49 cm ; 6 pcs /carton ; gw/nw: 10.9 kg/ carton



Scan Below QR code to watch product video



READY STOCK

# Bobby Bizz XDDDESIGN®

THE BEST BUSINESS BRIEFCASE + BACKPACK



INTEGRATED ZINC ALLOY LOCK IN THE RIGHT STRAP



QUICKLY LOCK YOUR BAG TO ANY FIXED OBJECT WITH THE INTEGRATED ZINC ALLOY LOCK



DISCREET POCKETS FOR EASY ACCESS



# Bobby Bizz

THE BEST BUSINESS BRIEFCASE + BACKPACK

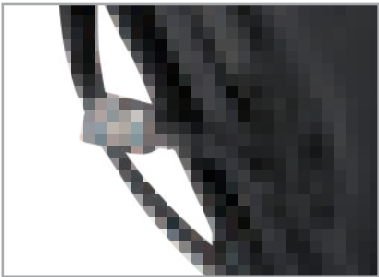
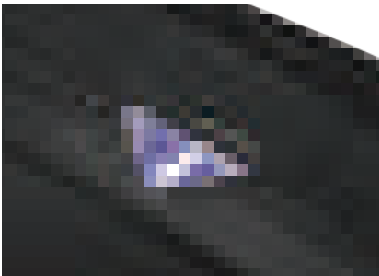

READY STOCK

PADDED INTERIOR  
LAPTOP, TABLET &  
ACCESSORY POCKETS

BACK PANEL WITH ELASTIC  
STRAP DESIGNED TO SLIP OVER  
TROLLEY HANDLES

INTEGRATED USB  
CHARGING PORT

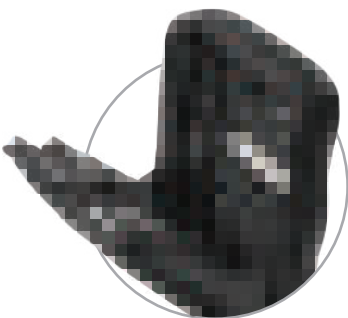

**BGXD 750 - BOBBY BIZZ**

XDDESIGN Bobby Bizz is the best Business Backpack + Briefcase. It is an Anti-theft backpack with a number of edge cutting features that makes you love this bag. It is one of the most funded projects on Kickstarter.

Product Size: 31 x 44.5 x 10 cm    Packing Details : 68 X 44 X 47 cm ; 6 pcs / carton ; gw / nw : 10.96 kg / carton



# SMART ORIGINAL ANTI-THEFT BACKPACK - BOBBY AND BOBBY XL

# XDDDESIGN®

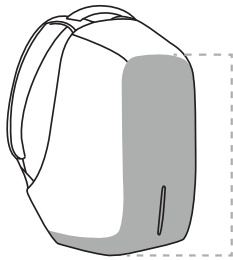

**The front and bottom of the backpack are made from recycled PU material.**

Don't worry about rain or water accidents, just one wipe with a cloth and your bag will look brand new.



### Anti-theft

Its genius lies in the zipper that is fully hidden at the back of the bag. No thief will be able to find the opening of the bag and thus a way to your belongings.



### Weight balance

The Bobby Anti-theft Backpack is designed in such a way as to distribute weight down and back, relieving downward pressure on your shoulders up to 25%.



### Cut proof

Designed with cut-proof PP protection board, the Bobby Anti-theft Backpack ensures your belongings remain safe.



### Night safety

The illuminant bars on the back and sides of the bag provide 360 reflector visibility up to 100m, ensuring your safety at night.

## 4 KEY FEATURES

Anti-theft, Cut-proof, Weight balance & night safety.

## Additional features



external USB charging port



discreet pockets for easy access



Scan Below QR code to watch product video



READY STOCK



CONCEALED BACK ZIPPERED POCKET FOR KEEPING VALUABLES SAFE



PADDED INTERIOR LAPTOP, TABLET & ACCESSORY POCKETS



BACK PANEL WITH ELASTIC STRAP DESIGNED TO SLIP OVER TROLLEY HANDLES



INTEGRATED USB CHARGING PORT

## Bobby



Black

## Bobby XL



Black



### BGXD 603 - BOBBY

XDDDESIGN® Every day 400,000 pick pocket incidents occur worldwide. Never worry about this happening to you with this Bobby anti-theft backpack! It's made out of high quality polyester and has reflective prints for your night safety. On the outside it has many hidden pockets for easy commuting. While on the inside there are padded compartments for a 15.6" laptop, tablet up to 10" and all your other belongings. Registered design®

Print Technique : SC, HT Preferred Print Location : Front  
Max Print Size : 180 x 240 mm Product Size : 44 x 28 x 13 cm  
Packing Details : 45 x 73 x 48.5 cm ; 6 pcs /carton ; gw/nw: 8.5 kg / carton

### BGXD 609 - BOBBY XL BACKPACK

XDDDESIGN® Every day 400,000 pick pocket incidents occur worldwide. Never worry about this happening to you with this Bobby anti-theft backpack! It's made out of high quality polyester and has reflective prints for your night safety. On the outside it has many hidden pockets for easy commuting. While on the inside there are padded compartments for a 17" laptop, tablet up to 12.9" and all your other belongings. Registered design®

Print Technique : SC, HT Preferred Print Location : Front  
Max Print Size : 80 x 40 mm Product Size : 47 x 13 x 31.5 cm  
Packing Details : 51.5 x 58.5 x 75 cm ; 6 pcs /carton ; gw/nw: 8 kg / carton



# BOBBY TECH

- > Solar Powerbank
- > Integrated Wireless Charger
- > Patented Fid Lock System
- > From The Popular Bobby
- > Anti-Theft Backpack Series



READY STOCK



**BGXD 621**

**XDDESIGN®** Bobby Tech is the ultimate backpack for gadget lovers; combining safety, comfort and the latest technology into great features. The integrated solar panel will ensure that you can charge your devices directly from solar power and never run out of power. An integrated wireless charging module makes sure you can charge your mobile device without the hassle of any cables. Bobby Tech has adjustable internal dividers which allow you to divide your backpack in many different ways. The patented fid lock system on the shoulder strap gives you quick and easy access to your phone or bottle/coffee cup. And of course the original Bobby features as hidden zippers, RFID protected pockets and cut proof PP board protection are still there. Registered design®

Print Technique : SC, HT  
Product size : 41 X 27.3 X 16.5 cm

Preferred Print Location : Side  
Packing Details : 68 x 44 x 47 cm ; 6 pcs /carton ; gw/nw: 7.5/8.5 kg / carton

Max Print Size : 80 x 90 mm



XDDDESIGN®  
**BOBBY URBAN**  
Anti-theft Backpack  
with Anti-cut Material



Scan Below QR  
code to watch  
product video



READY STOCK



ANTI CUT MATERIAL MADE FROM ULTRA-HIGH MOLECULAR WEIGHT POLYETHYLENE FABRIC + FIBRE GLASS POLYESTER



STEEL REINFORCED NUMBER LOCK MAKES IT IMPOSSIBLE TO OPEN OR CUT THROUGH THE BAG WHEN LOCKED TO A FIXED OBJECT

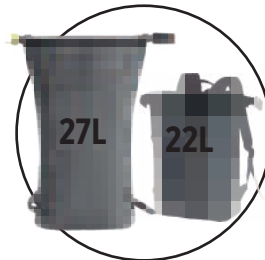

27L CAPACITY WHEN FULLY PACKED. SMALLEST CAPACITY WHEN FOLDED IS AROUND 22L

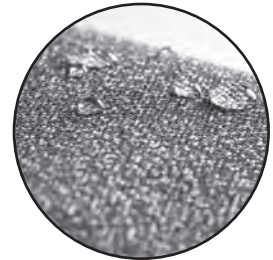

BOBBY URBAN IS WATER REPELLENT MAKING IT A RUGGED COMPANION INSIDE AND OUTSIDE THE CITY



STORE YOUR CARD IN A POCKET THAT PREVENTS RFID THEFT. IT IS IMPOSSIBLE FOR ANYONE TO ACCESS THE DATA ON YOUR CARD VIA RFID



NEED EVEN MORE CAPACITY? SIMPLY FIX THE NET AT THE FRONT OF THE BACKPACK TO SECURE YOUR FOOTBALL OR BASKETBALL



BACK PANEL WITH ELASTIC STRAP DESIGNED TO SLIP OVER TROLLEY HANDLES



HIDDEN POCKETS ON THE SHOULDER STRAP AND BACK OF THE BAG

**BGXD 605 - BOBBY URBAN**

XDDDESIGN® The Bobby Urban anti-theft cut-proof backpack is your safest travel companion yet. It's made of high quality anti-cut fabric and the main compartment can be completely locked with the steel reinforced combination lock. This function can also be used to lock the bag around a fixed object. There are hidden pockets on the backside and in the shoulder strap for cards, with RFID protection. The bag comes with a side water bottle pocket and detachable elastic net for your sports equipment. While on the inside there are padded compartments for a 15.6" laptop, tablet up to 12.9" and mesh pockets for your other belongings. Registered design®  
Print Technique : SC Preferred Print Location : Front Max Print Size : 80 x 40 mm  
Product Size: 32 x 47-64 x 15 cm Packing Details : 52 X 45 X 48 cms ; 6 pcs / carton ; gw / nw : 9.83 kg / carton





# Bobby Elle

## Anti - Theft Backpack

### Bobby for Her !!



Grey



READY STOCK



Light Blue

- > Anti-Theft
- > Cut Proof
- > Weight Balance



BOBBY ELLE

BGXD 613 - Grey    BGXD 616 - Light Blue

XDDESIGN® The Bobby Elle is not just a fashionable backpack, it also protects you from getting pickpocketed. With hidden zippers there is no way of getting into the backpack while carrying it. However strategically placed hidden pockets on the back of the backpack will give you as user easy access to smaller items when needed. The front of the backpack is protected with a PP board inside which will prevent thieves from cutting through the backpack and reflective strips on the front will ensure your night safety. This backpack will make sure your belongings will stay safe while keeping it fashionable. Registered design®

Print Technique : SC, HT

Preferred Print Location : Front

Max Print Size : 80 x 40 mm

Product Size : 30.5 x 23 x 11 cm

Packing Details : 36 x 57 x 58 cm ; 8 pcs /carton ; gw/nw: 10.01 kg / carton



Blue



Grey



Black



Exterior Fabric is Anti-Bacterial

READY STOCK

MALACCA

BPGL 671 - Black BPGL 672 - Grey BPGL 673 - Blue

Giftology Everyday backpack with Antibacterial exterior fabric to ensure that your backpack is free from harmful disease - causing bacteria. Commute and travel with this backpack without worrying about accumulating bacteria on your backpack during multiple contact with foreign surfaces. This backpack features a 15" laptop compartment, a USB external charging port, easy to access 2 front compartments and a water bottle pocket on the outside.

Print Technique : SC Preferred Print Location : Front Max Print Size : 200 X 150 mm  
Product size : 42 X 30 X 10 cm Packing Details : 60 x 45 x 42 cm ; 25 pcs /carton ; gw/nw: 13/12 kg/ carton



Blue



Grey



BARUTH

BPGL 674 - Black BPGL 675 - Grey BPGL 676 - Blue

Useful Backpack made out of GRS certified RPET material; Elegant design; User-friendly features  
Print Technique : SC, HT Preferred Print Location : Front Max Print Size : 200 x 150 mm  
Product size : 42 X 31 X 16 cm Packing Details : 46 x 35 x 47 cm ; 10 pcs /carton ; gw/nw: 12/13 kg / carton



**THIS BAG CARES FOR BOTH THE ENVIRONMENT AND YOUR HYGIENE**

**Features**

- RPET Antimicrobial External fabric
- UV-C Sterilization pocket on the front
- Fits laptop upto 15.6"
- Integrated External USB Output
- Padded interior laptop, tablet and accessory pockets
- Back panel with elastic strap to slip over trolley handles

**SANTHOME**



External Fabric Created From 100% Post-Consumer Recycled Plastic



**READY STOCK**

UV-C Sterilizing Pocket

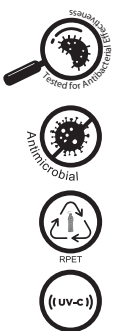

- External Fabric made from Recycled Post-consumer plastic
- UV-C Sterilizing pocket to Sanitize small articles as phone, wallet, currency etc On-the-go
- Outside material treated with Anti-Bacterial Technology
- Large capacity backpack with practical pockets

**BPSN 795 - CASTILE**

**SANTHOME PROTECT** Make the daily commute a little bit easier and a lot more safe with this laptop backpack with UV Sterilizing pocket. The bag is made from durable Anti-Bacterial 1680D RPET polyester fabric with rich PU details and features a pocket on the front in which you put any article for 5 min and get it out disinfected with UV-C technology. The built-in USB A cable needs to be connected to the powerbank (not included) in order to power the UV-C system. In addition to the roomy main compartment, this backpack features a padded 15.6" laptop pocket and an additional zipper pocket to hold your other daily essentials. Other features of this backpack include an USB output, and a side water bottle pocket.

Print Technique : SC  
Product size : 47 x 14 x 29 cm

Preferred Print Location : Front Top      Max Print Size : 100 x 40 mm  
Packing Details : 65 x 52 x 35 cm ; 10 pcs /carton ; gw/nw: 9.5 kg / carton



MOLESKINE



READY STOCK



NOMAD

BGMOL 103 - Black BGMOL 104 - Sapphire Blue

**MOLESKINE®** The Moleskine Nomad backpacks are designed to lightly encase everything you need to stay connected and creative on the move. Designed to feel weightless and very spacious, the Nomad bag is perfect to carry anything from documents and notebooks to pens, pencils, USB cables, headphones and all the things you need. Never leave home without missing anything and travel around the city with ease.

Print Technique : SC

Preferred Print Location : Flap

Max Print Size : 180 x 80 mm

Product size : 29.2 x 41.3 x 17.8cm

Packing Details : 32.5 X 20 X 45 cms ; 1 pcs / carton ; gw / nw : 1.85 kg / carton



READY STOCK



The ID Backpack has a range of features, including:

- Webbing to keep bag securely attached to luggage handles
- Designed to fit a range of devices and fits up to 15" laptops
- Front pocket with zip for easy access
- Internal side pocket for storing essential items
- Made of water-resistant nylon and tough coated canvas



BGMOL 101 - Black BGMOL 102 - Slate Grey

MOLESKINE® This smart, functional bag is made of sporty materials and has an intuitive fit. The ID Collection of bags are practical, comfortable and protective, and are able to adapt to your needs on the move from morning to night.

Print Technique : SC

Preferred Print Location : Flap

Max Print Size : 200 x 80 mm

Product size : 29.1 x 12.1 x 40.1 cm

Packing Details : 57.5 X 37 X 44 cm ; 4 pcs/carton ; gw/nw: 6.2 kg / carton



**External Features:**

- Webbing to keep the bag securely attached to luggage handles
- Front pocket with zipper for easy access
- Made of water-repellent nylon and durable coated canvas Zipper with Moleskine logo



READY STOCK



MBMOL 101 - Black MBMOL 102 - Slate Grey

**MOLESKINE®** An essential part of your urban nomadic kit: a practical, smart bag to carry your unique contents and tools as you move around the city. Bag can go everywhere with you, to work or around town. Essential equipment for the urban nomad. Follow your own track. Write your own story

Print Technique : SC

Preferred Print Location : Flap

Max Print Size : 250 x 80 mm

Product size : 39.1 X 13.1 X 28.1 cm

Packing Details : 57 X 43 X 34 cm ; 4 pcs/carton ; gw/nw: 6.2 kg / carton



READY STOCK



- > 17" Laptop Backpack
- > Tablet Compartment
- > Structured Design For Easy Use
- > Integrated External USB Port



BPSN 791 - ROSARIO

**SANTHOME** Rosario is an attractive backpack that looks professional, stylish, and comfortable to wear all-day long. It has one main compartment and pockets on the front & back to keep your essentials. An external USB allows you to charge your phone outside while keeping the power bank (not included) inside. Pocket on the shoulder strap allows you to your daily- use quick access cards for convenient use. Reflective tapes on the front and the back makes sure the bag is visible even in the dark. Packed in individual box.

Print Technique : SC Preferred Print Location : Front & Side  
Max Print Size : 110 x 80 mm Product Size : 47 x 32 x 15 cm  
Packing Details : 87 x 35 x 49 cm ; 5 pcs / carton ; gw / nw ; 13 kg / carton



- > 17" Laptop Backpack
- > Tablet Compartment
- > Structured Design For Easy Use
- > Integrated External USB port



BPSN 792 - POSADAS

**SANTHOME** Posadas is an attractive backpack that looks professional, stylish, and comfortable to wear all-day long. It has one main compartment and pockets on the back to keep your essentials. An external USB allows you to charge your phone outside while keeping the power bank (not included) inside. Pocket on the shoulder strap allow you to your daily use quick access cards for convenient use. Packed in individual box.

Print Technique : SC Preferred Print Location : Front & Side  
Max Print Size : 110 x 80 mm Product Size : 47 x 32 x 15 cm  
Packing Details : 87 x 35 x 49 cm ; 5 pcs / carton ; gw / nw ; 13 kg / carton





- Moulded Front Case That Provides Excellent Branding Possibility
- 15" Laptop Compartment
- 180 Degree Opening Large Compartment
- Quick Access Compartment On Front
- Trolley Strap On Back



READY STOCK

**BPSN 900- DRANCY**

SANTHOME Drancy is a moulded backpack with a 15" laptop compartment, a large main compartment to keep all your important stuff and a quick access front compartment to keep other gear. Back strap allows for the bag to be securely attached to a trolley.

Print Technique : SC

Preferred Print Location : Front

Max Print Size : 100 x 100 mm

Product Size: 46 X 31 X 17 cm

Packing Details : 50 x 50 X 32 cm ; 6 pcs /carton ; gw/nw: 6kg / carton



Blue



Black



READY STOCK

- > 15.6" Polyester Laptop Backpack
- > Tablet Compartment
- > Pockets On Shoulder Straps For Easy Use
- > Integrated External USB Port
- > Luggage Strap attaches to any trolley



- > 15.4" Laptop Compartment
- > Excellent Branding Possibilities
- > Two Main Compartments
- > High Quality Flat Grained PU Material



LUIJAN

BPSN 793 - Black    BPSN 794 - Blue

SANTHOME 2 main compartments, 2 side pockets, easy access compartment on the front & a quick access on the shoulder strap helps you store all your essentials in an organized manner.

Print Technique : SC    Preferred Print Location : Front  
Max Print Size : 170 x 110 mm    Product Size : 30 x 14.5 x 42 cm  
Packing Details : 50 x 37 x 54 cm; 10 pcs / carton ; gw / nw ; 8kg / carton

BPSN 921 - VINBAC

SANTHOME Vinbac is a laptop backpack for the stylish modern man. It is made from artificial leather and is lightweight and comfortable. It has a 15.4" laptop compartment. The double padded shoulder straps ensure comfortable carrying.

Print Technique : SC, ENG, UV, SC    Preferred Print Location : Front Pocket  
Max Print Size : 32 X 25 mm    Product Size : 30.5 X 15.5 X 43 cm  
Packing Details : 47 x 54 x 66 cm ; 6pcs /carton ; gw/nw: 7.5 kg / carton



Blue



Black



SHOBAC

BPSN 915 - Blue BPSN 916 - Black

**SANTHOME** Shobac is a 18"laptop backpack for the modern man who wants to work hard during the day and perform sports or go the gym in his leisure time. This backpack has 2 main compartments, a side mesh pocket, an air mesh back and high quality jaquard lining. Be active, Be smart!

Print Technique : SC, ENG Preferred Print Location : Front Flap Max Print Size : 140 x 50 mm  
 Product Size: 45 x 30 x 14.5 cm Packing Details : 49x 38 x 58 cm ; 10 pcs / carton ; gw / nw ; 13 kg / carton

READY STOCK



- > Big Capacity 18" Backpack
- > Integrated External USB Port
- > Back Padded For Comfort

BPSN 918 - ELEBAC

**SANTHOME** Elebac is a 18.5"laptop backpack made from 100% high quality nylon material and with two main compartments. The external charging USB allows your digital devices to be charged outside while your power bank sits inside the bag. The bag has high quality jaquard lining inside. For added comfort, the back panel is padded. There are comfortable and adjustable shoulder straps as well as a convenient top carry handle.

Print Technique : SC Preferred Print Location : Front Flap Max Print Size : 200 x 60 mm  
 Product Size: 47 x 30 x 14.5 cm Packing Details : 50 x 38 x 61 cm ; 10 pcs / carton ; gw / nw ; 8kg / carton



# PROMOTIONAL BACKPACKS & SCHOOL BAGS



Red

White

Black

- > 600D Day Bag
- > Perfect For Outdoor Excursions
- > Quick Access Pocket On Front
- > Light Weight

### ROTORUA

BPMK 114 - White BPMK 115 - Black BPMK 116 - Red

Day bag perfect for outdoor excursions. Made from 600D material, this light weight backpack lets you keep your tools safe in the front pocket and main compartment. Accessories in grey and padded back.

Print Technique : SC, HT Preferred Print Location : Front

Max Print Size : 90 x 90 mm Product Size : 23 x 40 x 12 cm

Packing Details : 50 X 50 X 28 cm ; 50 pcs/carton ; gw/nw: 6 kg / carton



Red

Black

Navy Blue

### SELFOSS

BPGL 801 - Black BPGL 802 - Red BPGL 803 - Navy Blue

Giftology Great value promotional backpack made from 600 D polyester. Consisting of Zipper main compartment, front compartment and adjustable shoulder straps.

Print Technique : SC, HT Preferred Print Location : Front

Max Print Size : 90 x 160 mm Product Size : 41 x 29 x 12.5 cm

Packing Details : 43 x 31 x 21 cm ; 25pc/carton ; gw/nw: 7.5 kg/carton

READY STOCK



### BPMK 119 - DUNEDIN

Rectangular backpack made of resistant 600D polyester with elegant black finish. With back padding and shoulder straps, Including a padded inside compartment for laptops up to 15 inches, plus a built-in headphones output.

Print Technique: SC, HT Print Location: Front

Max Print Size: 140 x 60 mm Product Size: 28 x 40 x 8 cm

Packing Details : 50 x 37 x 44 cm ; 11 kg Pcs: 30/ carton

### Giftology



### BPGL 780 - KADIE

Giftology Kadie is a basic backpack with one main compartment and two compartments on the front to keep small and easy to access items. Its padded back and shoulder straps makes it very comfortable to use.

Print Technique: SC, HT Print Location: Front Pocket

Max Print Size : 120 x 180 mm

Product Size : 42 x 29 x 16 cm

Packing Details : 47x 36 x 45 cm ; 30 pc/carton ;

gw/nw: 14 kg/carton

### Giftology



> One Main Compartment And Additional Compartment On Front

### BPGL 813 - KLOTEN

Giftology Basic 600D polyester backpack with zippered main & front compartment and adjustable shoulder straps

Print Technique : SC, HT Print Location : Front Top

Max Print Size : 150 X 90mm Product Size : 40 x 30 x 13.5cm

Packing Details : 45 x 35 x 43cm ; 40 pcs/carton ;

gw/nw: 12.5 kg/carton



Scan Below QR code to watch product video



Scan Below QR code to watch product video



READY STOCK



**BPSN 922- SINDAL**

SANTHOME Sindal is a daily use backpack with Three-Dimensional Tailoring and made from water-resistant and wear resistant premium fabric. The main compartment can store upto 15.4 inch laptop and 11 inch tablet and is designed with full open zipper to increase the practicability of storage. External USB output allows for your phone to be charged outside even when your powerbank is placed inside the bag. Mesh back pads and shoulder straps provide comfort and breathability.

Print Technique : SC Preferred Print Location : Front  
 Max Print Size : 120 X 150 mm Product Size : 45.5 x 14.5 x 30 cm  
 Packing Details : 68 X 35 X 50 cm ; 10pcs / carton ; gw / nw : 9.3 kg / carton



**MBSN 807- RONDE**

SANTHOME Ronde is a daily use messenger bag with Three-Dimensional Tailoring and made from water-resistant and wear resistant premium fabric. The main compartment can store upto 15.6 inch laptop and 11 inch tablet is designed with full open zipper to increase the practicability of storage. External USB output allows for your phone to be charged outside even when your powerbank is placed inside the bag. Mesh back pads and shoulder straps provide comfort and breathability.

Print Technique : SC Preferred Print Location : Front  
 Max Print Size : 150 x 150 mm Product Size : 40 x 11 x 31 cm  
 Packing Details : 57 X 35 X 44 cm ; 10pcs / carton ; gw / nw : 7.6 kg / carton

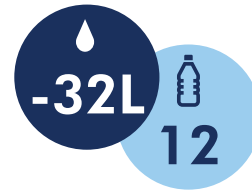

READY STOCK

- > Made from Recycled PET fabric certified by Global Recycled Standards
- > 3% of sales proceeds of each product is committed to Water.org
- > This bag saved 32 liters of water
- > Back trolley strap to attach backpack to trolley bag
- > This Bag is made by recycling 12 plastic bottles



**SAY NO TO GREENWASHING**

*Tell the true story of sustainability with genuine recycled rPET*

Certified by



**GIFTS THAT GIVE BACK**

💧 785 million people - 1 in 9 - lack access to safe water. We are supporting Water.org to change this.

💧 For each CHANGE bag sold, **3% of sales is donated** by brand owners to Water.org to save lives with safe water and sanitation.



MBSN 972 - OIKOS

SANTHOME CHANGE Laptop Office Bag made from high-end durable 1680D recycled rPET (certified by GRS) and stylish leather components. Convenience pockets in the front for quick access of mobile phones, documents, etc. Each bag saves 32L of water, reuses 12 plastic bottles and makes an impact by supporting Water.org to provide safe water to people in need with each purchase.

Print Technique : SC

Preferred Print Location : Front

Max Print Size : 170 X 200 mm

Product size : 38 x 28 x 7 cm

Packing Details : 69 x 60 x 49 cm ; 6 pcs /carton ; gw/nw: 10.9 kg/ carton



**SAY NO TO GREENWASHING**

*Tell the true story of sustainability with genuine recycled rPET and cotton with validated claims.*

Certified by Global Recycled Standard

**GIFTS THAT GIVE BACK**

- 785 million people - 1 in 9 - lack access to safe water. We are supporting Water.org to change this.
- For each IMPACT bag sold, **2% of sales is donated** by the Xindao B.V. (Netherlands) to Water.org to save lives with safe water and sanitation.



**READY STOCK**

- > 2% of proceeds of each product donated to Water.org
- > This bag is made of 26 recycled bottles
- > Made with AWARE™ tracer
- > This bag saved 15 liters of water

MBAW 461 - Black MBAW 462 - Navy Blue

**XD COLLECTION** No greenwashing, but telling a true story about sustainability! This Impact collection is made with AWARE™ tracer. With AWARE™, the use of genuine recycled fabric materials and water reduction impact claims are guaranteed, by using the AWARE disruptive physical tracer and blockchain technology. Save water and use genuine recycled fabrics. If you choose this item you save 15 litres of water and 26 plastic bottles have been reused. With the focus on water, 2% of proceeds of each Impact product sold is donated to Water.org. Casually professional and organised, the Impact 15.6" laptop bag is made for the modern professional with an eye for value and the environment. It features a classic design with front accent stitching, multiple storage pockets, two top handles, and an adjustable, detachable shoulder strap. The outer fabric and inner lining consist of 100% recycled polyester with AWARE™ tracer. PVC free.

Print Technique : SC Preferred Print Location : Front Max Print Size : 180 x 30 mm  
Product Size : 28 x 6 x 39.5 cm Packing Details : 49.5 X 38.5 X 48.5 cms ; 12 pcs / carton ; gw / nw : 5.5 kg / carton

## CROSS - The Iconic Brand

The iconic writing instruments brand established in the United States in 1846. Famed as the brand used by American Presidents, Cross Leather Accessories have been extremely successful and the award-winning leather accessories collection is currently being retailed in over 40 countries across the globe. Over a short span, the leather accessories under CROSS's banner has managed to gather a lot of fame with two consecutive wins in Germany this year at the Red Dot Design Awards and ILM Offenbach Awards. CROSS products form an excellent gifting option.

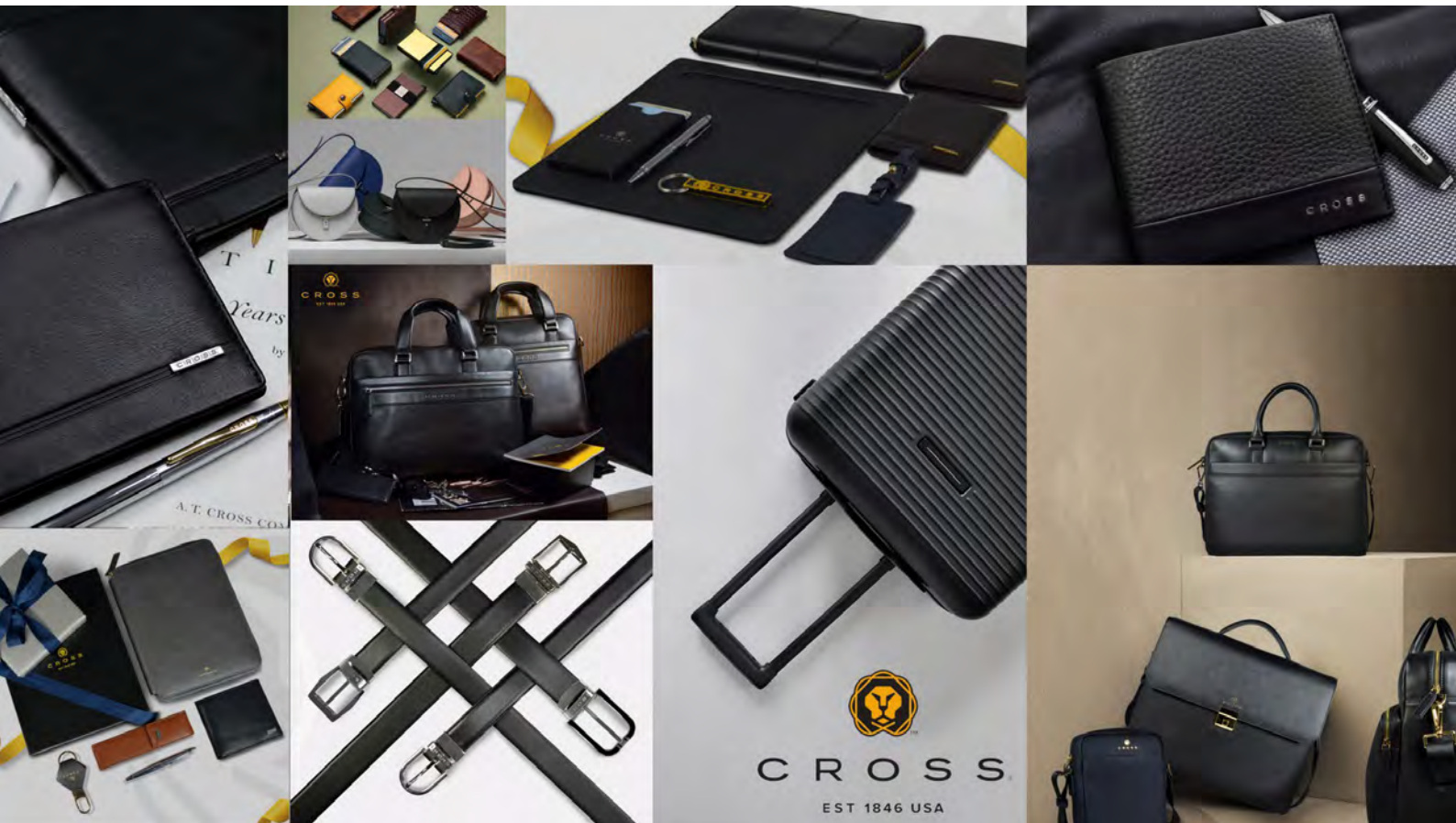





READY STOCK



DOMINIQUE

BPCRS 888 - CROSS Backpack

This CROSS Backpack is made up of durable and premium quality Nylon that gives it strength and durable for long term use. Its Ergonomic design, well padded adjustable shoulder straps ensure ease of carrying. This Backpack which is also good for travelling and has a capacity of 20 litres. It fits laptop upto 15.5" of most Brands. This Backpack has decent capacity to store essentials with one main compartment and one front pocket. It is thoughtfully designed to be used and serves the need of a professional office backpack, college bag, student backpack, school bag and is suitable for all; i.e , adults, teens, boys, girls, both men and women can use it for their day to day activities.

Print Technique : SC, HT

Preferred Print Location : Front Bottom

Max Print Size: 100 X 200 mm

Product Size: 42 x 30 x 12 cm



# CROSS LAPTOP BAG WITH TROLLEY STRAP



Brown



Black



Navy Blue

READY STOCK

- > Office Laptop Bag from Premium Vegan Leather
- > Trolley strap attaches to trolley bag for ease of travel
- > Shoulder strap-on the go

JASPER

MBCRS 882 - Black   MBCRS 883 - Brown   MBCRS 884 - Navy Blue

This is a 15" CROSS Briefcase that is made up of durable and Premium quality Vegan Leather which is designed to fit 15" laptops of most brands. It is Lightweight and comfortable to carry with adjustable shoulder strap. This Briefcase has decent capacity to store essentials with inside zipper pockets to put your valuable items along with 2 more utility pockets. It also has Zipper closure for handy access. It is perfect for business, travelling, meeting & shopping.

Print Technique : UV   Preferred Print Location : Front Bottom   Max Print Size : 40X 70 mm  
Product Size : 40 x 30 x 7 cm



Black



Brown

READY STOCK

- > Office Laptop Bag from Premium Vegan Leather
- >> Elegant Design
- >>> Shoulder strap-on the go



FRANCISCO

MBCRS 881 - Black MBCRS 887 - Brown

Francisco is a 15" CROSS laptop briefcase made from a durable and rich quality Vegan leather with durable polydrill lining. It comes with a removable & adjustable shoulder strap. The bag has classy distressed vintage inspired look which never goes out of style.

Print Technique : UV Preferred Print Location : Front Bottom Max Print Size : 35 X 60 mm

Product Size : 40 x 30 x 7 cm



# MESSENGER LAPTOP BAGS

## SANTHOME



Black

- > 15.4" Laptop Compartment
- > Tablet Compartment
- > Stylish Handle And Fittings



MENBAC

MBSN 806 - Black

SANTHOME Menbac is a classy office bag for men. It has an inner compartment for laptops upto 15.4" and two pockets on front and one on back to keep articles that require easy access. Its trendy design gives the user the style needed to create the perfect first impression in an important meeting.

Print Technique : SC, ENG

Preferred Print Location : Front Pocket

Max Print Size : 150 X 250 mm

Product Size : 40.5 X 4.5X 30 cm

Packing Details : 46 x 46 x 45 cm ; 5 pcs / carton ; gw/nw ; 5.8 kg/carton

READY STOCK



- > 15.6" Laptop Messenger Bag
- > Light-Weight, Waterproof Material
- > Multiple Convenience Pockets



MBXD 101- MADRID MESSENGER BAG

**XDCLUSIVE™** This 15.6" laptop bag offers comfortable style and safe storage for your laptop and tablet. With pockets to organize all of your tech gadgets and personal accessories. RFID safe sleeve for your wallet and passport. Connect your powerbank easily to the integrated USB charging port and charge your phone or tablet whilst on the go. PVC free. Registered design®

Print Technique : SC

Preferred Print Location : Front

Max Print Size : 150X 30 mm

Product Size : 32 x 9 x 43 cm

Packing Details : 47 x 38 x 67 cm ; 15 pcs/carton; 9 kg/carton

MBSN 801 - YOTEX

SANTHOME Yotex messenger laptop bag made from high quality, lightweight and waterproof Nylon material. It has a padded pocket for your 15.6" laptop. The magnetic strip allows for easy and secured closure of bag.

Print Technique : SC

Preferred Print Location : Front Pocket

Max Print Size : 180 x 150 mm

Product Size : 30 x 40 x 8 cm

Packing Details : 43.5 x 35 x 48 cm ; 10 pcs / carton ; gw/nw : 11 kg / carton



BEST IN CLASS BY **SANTHOME**



**Features to note:**

- Create your work station anywhere
- Water-proof exterior coating
- Adjustable screen height up to 19 cm
- Shock resistant case to protect your laptop
- Admirable interior fabrics
- Quick-stash charger pocket
- Eye-level video conferencing
- Ergonomic Design

**READY STOCK**



**MBSN 810 - EVRY**

**XDDDESIGN** Want to simply work on the go without hassle and have fast and easy pack up? Evry puts an end to the nasty neck pain laptops create and provides an incredible function that lets you view your laptop at your desired angle of view.

Print Technique : UV, ENG

Preferred Print Location : Plate

Max Print Size : 40 x 25 mm

Product size : 43 X 32 X 12 cm

Packing Details : 62 x 32 x 45 cm ; 5 pcs /carton ; gw/nw: 8.35 / 10 kg / carton



# OFFICE BAGS & CONFERENCE BAGS

## SANTHOME



Grey

Black

### GAYITI

MBSN 141 - Black MBSN 142 - Grey

**SANTHOME** Gayiti is a smart office bag with 15.6" laptop compartment and made from high grade PU leather. A large inner compartment is organized very effectively to provide enough space to hold your documents, books, laptop and other bulky items

Print Technique : SC, ENG, EMB Preferred Print Location : Top  
Max Print Size : 300 x 60 mm Product Size : 42 x 30 x 12.5 cm  
Packing Details : 47 x 35 x 44 cm; 10 pcs/carton; gw/nw: 15.9 kg/carton



Grey

Black

### TRITU

MBSN 143 - Black MBSN 144 - Grey

**SANTHOME** Tritu is an office bag that offers maximum protection using strong materials and a padded pocket for your laptop. It has two main compartments which offers enough space to carry all you need to your office. Two pockets on the front and one on the back provide additional storage space.

Print Technique : SC, ENG, EMB Preferred Print Location : Top  
Max Print Size : 300 x 50 mm Product Size : 42 x 30 x 12.5 cm  
Packing Details : 47 x 35 x 44 cm; 10 pcs/carton; gw/nw: 17.5 kg/carton

## Giftology



Navy Blue

Black

### KRIENS > Lightweight & Durable Messenger Bag

MBGL 205 - Black MBGL 206 - Navy Blue  
Print Technique : SC, HT Preferred Print Location : Front  
Max Print Size : 270 x 240 mm Product Size : 37 x 30 x 11.5 cm  
Packing Details : 45 x 35 x 38 cm; 30 pcs/carton; gw/nw: 13 kg/carton

## Giftology



### > 15" Laptop bag with leather zipper pullers

MBGL 201 - XINTIN

**Giftology** Xintin is an essential messenger bag with one main compartment having a laptop pocket and one compartment on the front to store small and easy to access items. It is made from a combination of 2 materials. It also consists of leather zipper pullers.

Print Technique : SC, HT Preferred Print Location : Front  
Max Print Size : 240 x 100 mm Product Size : 40 x 28 x 9 cm  
Packing Details : 47 X 35 X 48 cm; 20 pcs/carton; gw/nw: 8 kg/carton



Red



Grey



Black



Blue

### VENTA

DBMK 101 - Black DBMK 102 - Blue DBMK 103 - Grey DBMK 104 - Red  
Document bag with zipper closure in soft 600D polyester finish in bright tones. With reinforced carrying handles in matching color, zipper and matching color side holders.

Print Technique : SC, HT Preferred Print Location : Front Pocket  
Max Print Size : 265 X 200 mm Product Size : 36.5 X 29 X 6 cm  
Packing Details : 31 X 35 X 44 cm; 100 pcs / carton ; gw / nw : 13 kg / carton

READY STOCK



Giftology

Giftology

Navy/Grey



Black/Grey



- > 600D Polyester Duffle Bag
- > Lightweight & Durable

LYSS

TBGL 101 - Black/Grey TBGL 102 - Navy/Grey

Giftology Lyss is a 600D polyester duffle bag which offers a lot of space for you to fill in all your items to carry for your trip. On the outside, it features 2 net pockets on the sides which gives you easy access to your belongings along with a pocket on the front of the bag. This value bag is sure to fulfil your advertising motive.

Print Technique : SC, HT Preferred Print Location : Front Pocket  
Max Print Size : 150 x 130 mm Product Size : 52 x ø25 cm  
Packing Details : 55 x 43 x 35 cm; 30pcs/carton; gw/nw: 13 kg/carton



BPGL 805 - LANDSKRONA

Giftology Landskrona is a useful cooler bag with adjustable shoulder strap made from fashionable 2 tone material. It has a pocket on the front and the inside is well protected to keep your food fresh for a longer time.

Print Technique : SC, HT Preferred Print Location : Front  
Max Print Size : 110 x 70 mm Product Size : 20 x 15 x 15 cm  
Packing Details : 65 x 36 x 42 cm; 80 pcs/carton; gw/nw: 15 kg/carton

READY STOCK

SANTHOME

Capacity: 6800 ml



- > Food Safe Material
- > Party Bag With Party Container & Tray
- > Easy To Carry
- > Aluminium Foil & Insulation Insideto Keep Cool / Hot

SN 5101 - PICFUD

Print Technique : SC Preferred Print Location : Top  
Max Print Size : 300 x 200 mm Product Size : 27 x 42 x 12 cm  
Packing Details : 46 x 30 x 53 cm; 4 pcs /carton; gw/nw : 4.5 kg / carton



BPMK 101 - TRAKAI

Non-Woven/ Aluminium Multi purpose cooler bag in brightly colored non-woven, with zipperclosure and front pocket. With practical carrying handle in matching color.

Print Technique : SC Preferred Print Location : Bag Center  
Max Print Size : 140 X 100 mm Product Size : 27 X 31 X 15 cm  
Packing Details : 56 X 35.5 X 63 cm; 100 pcs / carton ; gw / nw : 9.5 kg / carton



## DRAWSTRING BAGS

### Giftology



White



Black



Navy Blue

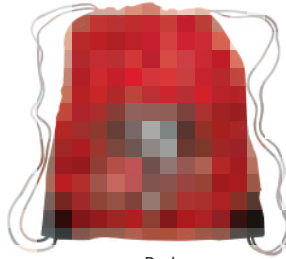

Red

#### DRASTIN

**BPDS 801** - White **BPDS 802** - Navy Blue **BPDS 803** - Red **BPDS 804** - Black  
Giftology Drastin is a 210D polyester drawstring bag with one main large compartment. The drawstring design is for shoulder or backpack carrying. The large imprint space makes this a very affordable giveaway with great brand visibility.

Print Technique : SC, HT      Print Location : Front  
Max Print Size : 230 x 320 mm      Product Size : 44 x 33 cm  
Packing Details : 38 x 52 x 40 cm ; 500 pcs/carton ; gw/nw: 20 kg/carton



#### BPMK 108 - PAPATOETOE

Drawstring backpack in 210T soft polyester, in shiny silver color with thick, black self closing strings and reinforced corners.

Print Technique : SC      Preferred Print Location : Front  
Max Print Size : 300 x 360 mm      Product Size: 34 x 42 cm  
Packing Details : 42 X 42 X 50 cm ; 9.5 kg Pcs: 200/ carton

READY STOCK



Orange



Green



Yellow



Light blue



Pink

#### WAITEMATA

**BPMK 103**- Orange **BPMK 104**- Light blue **BPMK 105**- Pink **BPMK 106**- Green **BPMK 107**- Yellow

Drawstring backpack in soft polyester 210T in cheerful and wide range of colors. With black self closing strings, corners with metal eyelets and PU leather reinforcement in matching color.

Print Technique : SC, HT      Preferred Print Location : Front      Max Print Size : 230 x 320 mm  
Product Size: 44 x 33 cm      Packing Details : 23 X 50 X 45 cm ; 300 pcs /carton ; gw/nw: 11 kg / carton

### LIVE YOUR DREAM !!!







INCREASED FOCUS ON  
**REDUCING  
THE USE OF  
PLASTIC**

According to United Nations Environment Programme Each year, more than 8 million tonnes of plastic ends up in the oceans, wreaking havoc on marine wildlife, fisheries and tourism, and costing at least \$8 billion in damage to marine ecosystems. Up to 80 per cent of all litter in our oceans is made of plastic.

“waste is one the greatest environmental challenges facing the world, which is why protecting the marine environment is central to our agenda The Financial Times, 2018”



KOSZEJ

CTEN 103 - Grey CTEN 104 - Blue

Draw String Bag in Herringbone Weave

Print Technique : SC, HT Preferred Print Location : Front and Back Max Print Size : 300 x 400 mm

Product Size : 36 X 46 cm Packing Details : 46 x 46 x 38cm; 100 pcs/carton; gw/nw: 12.53 kg/carton



Blue

eco-neutral



Grey

READY STOCK



Natural

eco-neutral



BPMK 110 - PAPAKURA

Drawstring backpack in 100% cotton fabric with soft finish in natural color. With matching color self closing strings. 110gsm cotton.

Print Technique : SC, HT Preferred Print Location : Front, Back

Max Print Size : 300 x 350 mm Product Size : 37 x 41 cm

Packing Details : 33 X 44 X 45 cm ; 14.5 kg Pcs: 250/ carton



White

CT 401 - ZITUTE

eco-neutral Cotton Draw String Bags

Print Technique : SC, HT Preferred Print Location : Front & Back

Max Print Size : 330 x 300mm Product Size : 34 x 42cm

Packing Details : 46 x 46 x 48cm; 200 pcs/carton; gw/nw: 20.90 kg/carton



# NON WOVEN SHOPPING BAGS

*Eco friendly / cost effective / ideal for exhibitions*



Black



Royal Blue



White



Navy Blue



Cream



Red

**NW 001 V - NONWOA SOLID**

Print Technique : SC, HT

Preferred Print Location : Front & Back

Max Print Size : 260 x 300 mm

Product Size : 38 x 30 x 10 cm

Packing Details : 68 x 42 x 37.5 cm; 250 pcs/carton; gw/nw: 11.3 kg/carton



White/R.Blue



White/Grey



White/Black



White/Green



White/Navy



White/Orange



White/Red



White/Maroon

**NW 001 V - NONWOA EDGE**

Print Technique : SC, HT

Preferred Print Location : Front & Back

Max Print Size : 260 x 300 mm

Product Size : 38 x 30 x 10 cm

Packing Details : 68 x 42 x 37.5 cm; 250 pcs/carton; gw/nw: 11.3 kg/carton



White



Black

**NW 001 H - LUKAOK**

Print Technique : SC, HT

Preferred Print Location : Front & Back

Max Print Size : 390 x 250 mm

Product Size : 33 x 43 x 12 cm

Packing Details : 74 x 47 x 37.5 cm; 250 pcs/carton; gw/nw: 14 kg/carton



READY STOCK



eco friendly / cost effective / all purpose bags



White



Natural



JT 101 - SISMAC

Print Technique : SC, HT Preferred Print Location : Front & Back  
Max Print Size : 250 x 300 mm Product Size : 38 x 30 x 12 cm  
Packing Details : 56 x 56 x 38 cm ; 100 pcs /carton ; gw/nw: 21.40 kg / carton

➤ Front Pocket for convenience;  
Option of 3 Colors



Natural



Black



Blue

MONCLOVA

JTEN 432 - Natural JTEN 433 - Black JTEN 434 - Blue

Jute Bag with Front Pocket  
Print Technique : SC, HT Preferred Print Location : Front & Back  
Max Print Size : 380 x 230 mm Product Size : 44.5 x 35.5 x 11.5 cm



Natural



White



JT 201 - KRISKIT

Print Technique : SC, HT Preferred Print Location : Front & Back  
Max Print Size : 380 x 270 mm Product Size : 33 x 43 x 15 cm  
Packing Details : 56 x 56 x 38 cm ; 80 pcs /carton ; gw/nw: 20.4 kg / carton



CTEN 101 - BAJA

Cotton Shopping Bag with Jute Gusset  
Print Technique : SC, HT Preferred Print Location : Front  
Max Print Size : 280 x 230 mm Product Size : 30 x 37 x 12.5 cm  
Packing Details : 34 x 42 x 40 cm ; 100 pcs /carton ; gw/nw: 8 kg /carton



READY STOCK



# ECO COTTON BAGS

White



White



eco-neutral



Natural



Natural



READY STOCK



**CT 001 - STRUM**

Print T : SC, HT      Print L : Front & Back  
Max Print Size : 320 x 340 mm      Product Size : 42 x 38cm  
Packing Details : 46 x 46 x 48 cm ;  
250 pcs/carton; gw/nw: 19.50 kg/carton



**CT 101 - TSIO**

Print T : SC, HT      Print L : Front & Back  
Max Print Size : 260 x 300 mm      Product Size : 38 x 32 x 12cm  
Packing Details : 46 x 46 x 48 cm ;  
150 pcs/carton; gw/nw: 20 kg/carton



**CT 501 - CAPTRU**

eco-neutral Cotton wallet with Foldable shopping bag  
Print T : SC, HT      Print L : Pouch & Bag  
Max Print Size : (Bag) 270 x 290 mm  
(Pouch) 80 x 50 mm  
Product Size : 12 x 11 x 3.5 cm (Pouch) 32 x 33 (Bag)  
Packing Details : 46 x 46 x 48 cm ;  
225 pcs/carton; gw/nw: 18.375 kg/carton



Green



Blue



**CT 301 - SUSINOC**

Cotton Toiletry Pouch  
Print T : SC, HT      Print L : Front  
Max Print Size : 190 x 70 mm  
Product Size : 23 x 13 x 5cm  
Packing Details : 56 x 56 x 38 cm ;  
100 pcs/carton gw/nw: 20.8 kg/carton



**CT 601 - TRUIO**

Cotton Tablet Case  
Print T : SC  
Print L : Front  
Max Print Size : 230 x 110 mm  
Product Size : 29 x 22 x 5 cm



**BREA**

**BPMK 128 - Blue    BPMK 130 - Green**

Bag made from 100% cotton material and in combination of body of natural color and handles in a varied range of bright tones. With 70cm long handles and stitched finishing. Takes up to 7kg of weight. 105 gsm.  
Print Technique : SC, HT      Preferred Print Location : Front  
Max Print Size : 330 x 350 mm      Product Size : 37 x 41 cm  
Packing Details : 45 x 40 x 30 cm ;  
250pcs / carton ; gw / nw : 12 kg / carton

# ECO/RECYCLED PET (RPET) BAGS/HAPPY BAGS



*eco friendly / cost effective / all purpose bags*



Heart



Smile



Sunglass



Wink

ARTESIA

BPMK 122 - Heart BPMK 123 -Sunglass BPMK 124 - Wink BPMK 125 -Smile

Folding bag with fun emoji designs in eye-catching yellow color. Made of soft 190T polyester, with matching color drawstring and adjustment accessory.

Print Technique : SC, HT

Preferred Print Location : Front

Max Print Size : 265 x 200 mm

Product Size: 40 x 38 cm

Packing Details : 20x 45 x55 cm ; 400 / carton ; gw / nw : 10 kg / carton



White / green



White



RPET 001 - ANOKIS

Recycled RPET Bag

Print Technique : SC

Preferred Print Location : Front & Back

Max Print Size : 260 x 300 mm

Product Size : 38 x 30 x 12 cm

Packing Details : 34 x 42 x 40 cm ; 100 pcs/carton ; gw/nw : 8 kg /carton



BPMK 127 - BRAWLEY

Bag made from 100% organic cotton material with natural color finish. With reinforced short handles of 35cm in green color, gussets and stitched finishing. Takes up to 9kg weight. 145gsm.

Print Technique : SC, HT

Preferred Print Location : Front

Max Print Size : 360 x 340 mm

Product Size : 40 x 40 x 10 cm

Packing Details : 38 x 44 x 54 cm ; 200 pcs / carton ; gw / nw : 17 kg / carton

READY STOCK



# GRS-CERTIFIED RECYCLED COTTON BAGS

# eco-neutral



## DO YOU KNOW THE WATER FOOTPRINT OF COTTON?

It takes **20,000 Liters of water** to produce 1 kg of cotton fiber.

Source: WWF

Continue reading →

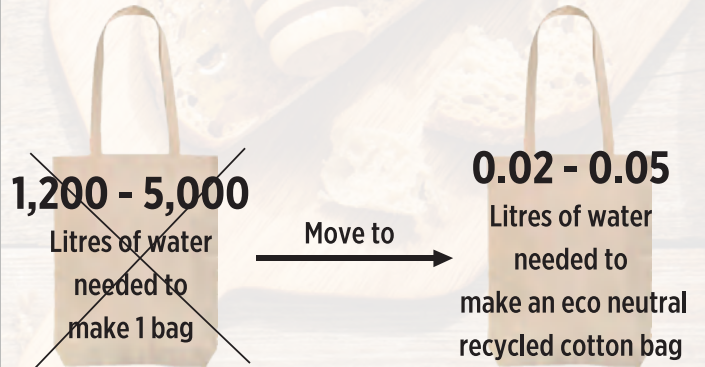

## Please choose responsibly!

READY STOCK

300 GSM Sturdy Fabric



This Bag Saved

**-4,000 Litres**  
Water



CTEN 425 - BORKUM

Eco neutral GRS-Certified Recycled Cotton Beach Bag in Natural color - Least / almost NIL Impact on environment

Print Technique : SC

Max Print Size : 330 x 420 mm

Preferred Print Location : Front

Product Size : 40 x 47 x 17 cm



This Bag Saved

**-1,200 Litres**  
Water

140 GSM Light & Durable



Natural



Blue



Black



ABLAR

CTEN 421 - Natural

CTEN 422 - Black

CTEN 423 - Blue

Eco neutral GRS-Certified Recycled Cotton Tote bag 140 gsm

Print Technique : SC

Max Print Size : 350 x 320 mm

Preferred Print Location : Front

Product Size : 42 x 36 cm

This Bag Saved

**-10,000 Litres**  
Water



300 GSM Sturdy Fabric



DBEN 430 - PUEBLA

Eco neutral GRS-Certified Recycled Cotton Duffel Bag in Natural color - Least / almost NIL Impact on environment

Print Technique : SC

Max Print Size : 180 x 160 mm

Preferred Print Location : Front Pocket

Product Size : 49 x ø26 cm

- Outside Zipper pocket for quick access & safety
- Easy to wash-&-Clean

This Bag Saved

300 GSM Sturdy Fabric

**-4,000 Litres**  
Water

Natural

Black



DARGUN

CTEN 427 - Natural

CTEN 428 - Black

Eco neutral GRS-Certified Recycled Cotton Tote Bag with Bottom Gusset 300 GSM

Print Technique : SC

Max Print Size : 300 x 320 mm

Preferred Print Location : Front

Product Size : 42 x 38 x 10 cm

# Recycled PET Fabric Process

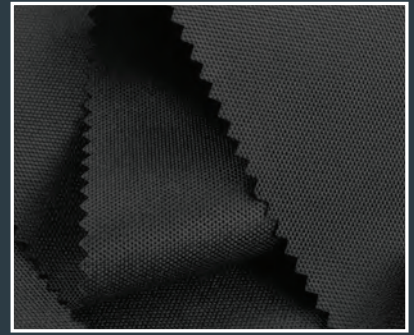
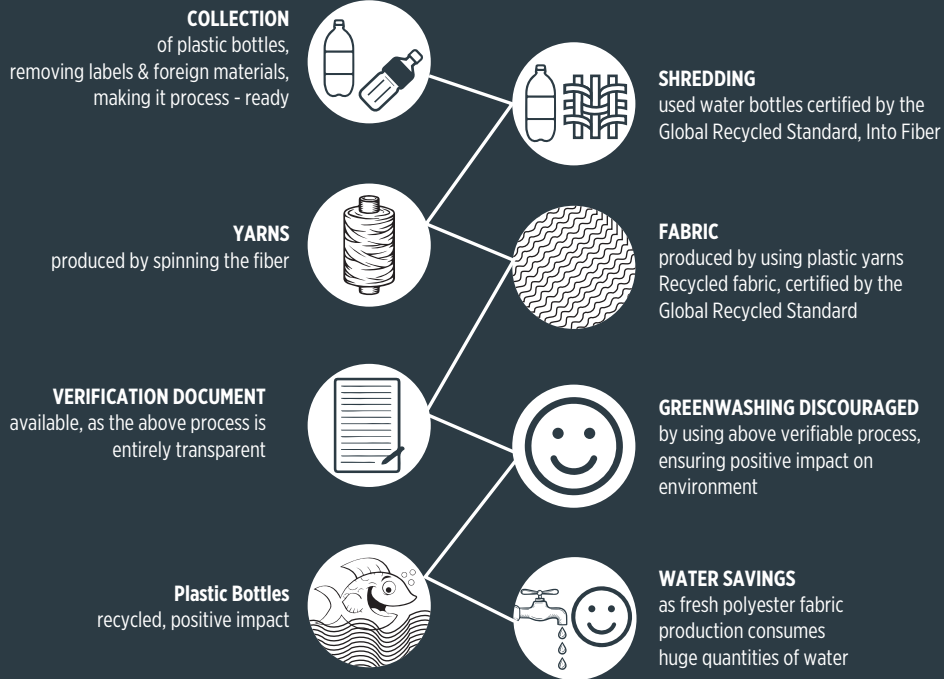

Recycled PET Fabric

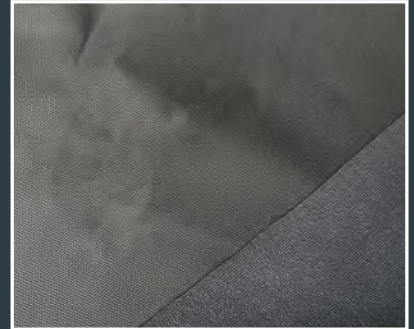

**We Stock Recycled PET fabric & can supply Bags / Pouches made from GRS certified RPET fabrics in our U.A.E. factory**



## Benefits of producing Recycled PET fabric over normal fabric:

- Saves Energy
- Reduce pollution (CO<sub>2</sub> emissions)
- Fabric is sturdy - can produce Backpacks, Pouches, Laptop bags, Cooler bags.





# CUSTOM MADE MISCELLANEOUS ITEMS

## Islamic Gifts



Navy Blue

Grey

**PMT 001 - MATIER**  
Product Size : 38 x 29 x 3.5 cm

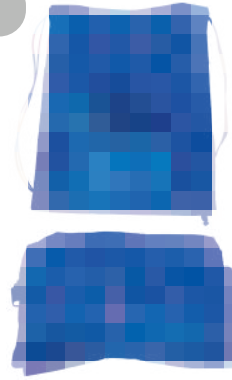

Prayer Mat

Foldable Bag

Sleeper Bag

**Foldable Haj - Umrah Set**



Car kit A



Tool kit pouch A  
(No accessories included)

CUSTOM MADE



Bean bag

## File Cases & Folders

FC 002



FC 001



**WC 001**  
(Indian)

**Spare wheel cover**  
Available in Indian & Korean rexines

**WC 002**  
(Korean)



Travel kit





HAND CARRY FOOD DELIVERY BAG

BIKE RIDER  
FOOD DELIVERY BACKPACK



CUSTOM MADE

Pizza Delivery Bag



PORTABLE LUNCH BAG



# CUSTOM MADE BACK-TO-SCHOOL ITEMS



CUSTOM MADE





**SB 201**  
Duffel bag with shoe compartment



**CBB 001**  
Cross Body Bag



**SB 001A**  
Sling Bag



**SB 001**

CUSTOM MADE

**Documents Bags**



**EX 001**  
Material: 600D



**LT 001**  
Laptop Sleeve 15"

**Laptop Backpack**



**LP 1010**  
Executive Laptop Backpack



# CUSTOM MADE BAGS



## Cooler Bags



**CB 701 A**  
Foldable string bag  
+ Cooler bag



**CB 003 A**



**CB 004 A**



**CB 001 A**



**CB 502 A**

## Duffle Bag



**DF 002 A**

## Cosmetics Pouch / Gift Pouch



**CP 005**

## Transparent Pouch



**CP 006**

## String Bag



**ST 101 B**  
Drawstring bag with front zipper pocket

## First Aid Kit



CUSTOM MADE



**JC 0102**  
JUCO Shopping Bag

## Waist Pouches



**WP 002 A**



**WP 001 A**



**WP 003 A**



FO - 005



FO - 003



TB-101



BF - 002  
Bill Folder



Certificate Holder



Warranty Card



i Pad holder



CUSTOM MADE

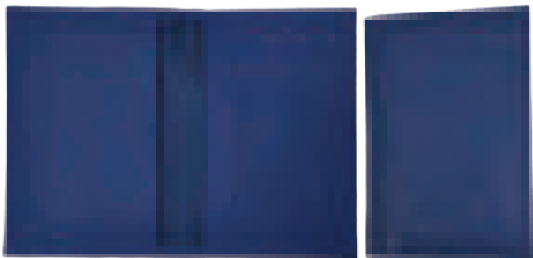

Passport Cover



Credit Card Holder



Ladies wallet with mobile pocket

# THE END OF GREENWASHING

Greenwashing refers to false sustainability claims - a growing problem for the modern conscious buyer

We believe true sustainability starts with **TRANSPARENCY & TRACEABILITY**

Our new **CHANGE** collection aims to end greenwashing and lead our industry in a new direction



With every purchase of CHANGE collection products, **a donation is made to Water.org**, a non-profit that provides access to safe water and sanitation. They have helped **over 36 million** people access safe water to date!

**CHANGE.**  
SERIOUS SUSTAINABILITY

*CHANGE Collection is about design, serious sustainability and giving back.*

*All recycled fabrics are certified by the Global Recycled Standard.*

***Gifts that give water:** 3% of sale proceeds from this collection is committed by brand owners to Water.org to save lives with safe water*





Blue

Grey

White

Green

Aqua Green



Black

READY STOCK

## STAINLESS STEEL BOTTLE WITH BAMBOO LID

### QUALITY

- > Double-Walled water bottle
- > SS 304 Inside, SS 201 Outside
- > 560 ml Capacity
- > Vibrant Colors
- > High quality
- > 3% of sales proceeds of each product committed to Water.org
- > 24 hours cold, 8 hours hot

### GIFTS THAT GIVE BACK

- 💧 785 million people - 1 in 9 - lack access to safe water. We are supporting Water.org to change this.
- 💧 For each CHANGE bottle sold, **3% of sales is donated** by the brand owners to Water.org to save lives with safe water and sanitation.



BREDA

DWHL 337 - Black DWHL 338 - White DWHL 339 - Grey DWHL 340 - Blue DWHL 343 - Green DWHL 344 - Aqua Green

Hans Larsen™ Breda is part of Hans Larsen CHANGE. Collection. Proudly use this bottle knowing that you have made a Change in someone's life through our contribution to water.org.

Print Technique : ENG, UV, SC  
Product Size: ø7 x 24.5 cm

Preferred Print Location : Front & Top      Max Print Size : (Front) 120 x 25 mm (Top) ø 40 mm  
Packing Details: 39.5 X 39.5 X 28.5 cms ; 25 pcs / carton ; gw / nw : 9.5 / 7.5 kg / carton



QUALITY



READY STOCK



## STAINLESS STEEL TUMBLER WITH METAL STRAW

- > 3% of sales proceeds of each product committed to Water.org
- > 15 hours cold, 5 hours hot
- > High-end Tumbler with flexible straw
- > Straw Cleaner in high quality stainless steel included
- > 540 ml Capacity
- > Double-Walled
- > SS 304 Inside, SS 201 Outside

### GIFTS THAT GIVE BACK

- 785 million people - 1 in 9 - lack access to safe water. We are supporting Water.org to change this.
- For each CHANGE tumbler sold, **3% of sales is donated** by the brand owners to Water.org to save lives with safe water and sanitation.



BORCULO

DWHL 331 - Black DWHL 332 - White

Hans Larsen™ Borculo prevents drinks from spilling, the straw ensuring you drink comfortably on the move. A highly elegant Tumbler whose purchase triggers a contribution to water.org ensuring safe water to someone in need.

Print Technique : ENG, UV, SC  
Product Size: ø8 x 17 cm

Preferred Print Location : (Colored Front) (Steel Front) Max Print Size : (Colored Front) 100 x 25 mm (Steel Front) 30 x 25 mm  
Packing Details : 57 X 34 X 25 cms ; 30 pcs / carton ; gw / nw : 10.9 / 8.6 kg / carton





Black

Aqua Green

Grey

White

Blue

Green

READY STOCK

## STAINLESS STEEL MUG WITH BAMBOO LID

QUALITY

### GIFTS THAT GIVE BACK

- > 3% of sales proceeds of each product committed to Water.org
- > 15 hours cold, 5 hours hot
- > A Designer Mug that supports Sustainable living
- > Double-Walled
- > SS 304 Inside, SS 201 Outside

- 💧 785 million people - 1 in 9 - lack access to safe water. We are supporting Water.org to change this.
- 💧 For each CHANGE mug sold, **3% of sales is donated** by the brand owners to Water.org to save lives with safe water and sanitation.



LAREN

DWHL 334 - White DWHL 333 - Black DWHL 336 - Green DWHL 335 - Blue DWHL 341 - Grey DWHL 342 - Aqua Green

*Hans Larsen*™ Inspired by Scandinavia, Laren is created for the discerning connoisseur who loves the best. 3% of the sale proceeds go to water.org to change someone's life.

Print Technique : ENG, UV, SC  
Product Size : ø8.5 x 11 cm

Preferred Print Location : Front of Mug & Lid of Mug

Max Print Size : (Front of Mug) 50 x 25 mm (Lid of Mug) ø 80 mm

Packing Details : 55.5 X 28.5 X 27 cms ; 36 pcs / carton ; gw / nw : 10.6 / 8.6 kg / carton



- > Stainless Steel Water Bottle
- > SS 304 Inside, SS 201 Outside
- > Double Walled Vacuum
- > 24 Hours Cold & 8 Hours Hot
- > Leak Proof
- > Screw-On Cap; BPA Free
- > 500 ml Capacity



READY STOCK



### GIFTS THAT GIVE BACK

- 💧 785 million people - 1 in 9 - lack access to safe water. We are supporting Water.org to change this.
- 💧 For each CHANGE bottle sold, **3% of sales is donated** by the brand owners to Water.org to save lives with safe water and sanitation.



HUNFELD

DWHL 280 - Black DWHL 281 - White

Hans Larsen™ CHANGE Double Walled Stainless Steel Vacuum Water Bottle (500ml). This bottle makes an impact by supporting Water.org to provide safe water to people in need with every purchase. Packed in an elegant recycled gift box.

Print Technique : UV, SC, ENG

Preferred Print Location : Front

Max Print Size : 110 X 20 mm

Product size : ø 6.8 x 26 cm

Packing Details : 45 x 30.5 x 28.4 cm ; 24 pcs /carton ; gw/nw: 6.5/8 kg/ carton

**1 Ocean bottle = 1000 Ocean - Bound Plastic Bottles Collected**



*"Ocean bottle is the first tangible ocean impact we have"*

**London Evening Standard**

*"If Apple designed a drinks container for life, this would be it."*

**THE TIMES**

*"Fighting plastic pollution at a grassroots level"*

**Forbes**



# SERIOUSLY SUSTAINABLE DRINKWARE

When you buy an Ocean Bottle, you fund the collection of 1000 ocean-bound plastic bottles in weight.

Locals in coastal communities turn these bottles into a sustainable livelihood, using our innovative exchange platform.

We're making a real impact. Be a part of it.

## CASE STUDIES



ocean bottle

### WHY OCEAN BOTTLE

- Internal Merchandising Webshop
- Split orders across Multiple offices to get quantity discount
- Used for ESG Focused stakeholder gifting



#### GIFTING



504

OB'S PURCHASED



504,000

PLASTIC BOTTLES COLLECTED



5,746

KGS OF OCEAN BOUND PLASTIC



ocean bottle

### WHY OCEAN BOTTLE

- Mercedes HQ purchased bottles for prospective client gifts at Corporate Event focused on;
  - Golf Events
  - Motorsport Events
- The events Include:
- Ladies Business Cup
  - AWGC Tour
  - Mercedes Trophy Golf
  - Mercedes-AMG Track days



#### GIFTING



4,100

OB'S PURCHASED



4,100,000

PLASTIC BOTTLES COLLECTED



46,740

KGS OF OCEAN BOUND PLASTIC



ocean bottle

### WHY OCEAN BOTTLE

- Engaged 2000 employees in the Nordics with a corporate social ocean saving initiative
- Plastic-free mission on-site, they gave employees a headstart in using a reusable bottle instead of buying a plastic water bottle



#### COMPANY GIFTING



2,000

OB'S PURCHASED



2,000,000

PLASTIC BOTTLES COLLECTED



22,800

KGS OF OCEAN BOUND PLASTIC



# Corporate's Certificate (example)

## CERTIFICATE OF SOCIAL PLASTIC COLLECTION

PROUDLY AWARDED TO  
**EXAMPLE COMPANY**

IMPACT CERTIFICATE

FOR PREVENTING  
**46,609 KGS**  
FROM ENTERING OUR OCEAN.

POWERED BY IBM BLOCKCHAIN+

ISO 17033 Ethical Claims Verified  
26000 Social Responsibility Verified  
SEDEX Compliant

Will Pearson  
CEO & Co-Founder

Nick Doman  
COO & Co-Founder

January 2021  
[www.oceanbottle.co](http://www.oceanbottle.co)  
@oceanbottle

READY STOCK

## INTERACTIVE PACKAGING THAT TELLS THE STORY OF THE IMPACT

**Small Bottle BIG IMPACT**

This is the bottle that stops 1000 plastic bottles from entering the ocean

Discover more

**ocean bottle**  
Obsidian Black  
230g | 600ml

**HOW IT WORKS**

**YOU**  
Buy one Ocean Bottle and help stop the 22 million kgs of plastic entering our ocean each day

**1 FOR 1000**  
Each Ocean Bottle funds the collection of 11.4kg of ocean bound plastic, equivalent to 1000 500ml plastic bottles

**PLASTIC COLLECTORS**  
Plastic is collected by locals living in coastal communities around the world and enabled by our partners

**FINANCIAL EMPOWERMENT**  
Collectors can exchange plastic for money or digital tokens to swap for healthcare, tuition, tech goods or micro-finance

**CLOSING THE LOOP**  
Ocean bound plastic is recycled into new products, helping turn the tap off ocean plastic

- NFC Smart chip enabled for more impact
- Easy carry loop
- Hot & cold stainless steel vacuum insulation
- Double opening for easy clean and use
- Anti-leak seal
- Dishwasher safe up to 60°

**ocean bottle**

BranchHid of Oslo  
Designed by K&B Norway  
Responsibly made in the highlands  
Made from BPA free & recyclable plastic, silicone rubber & stainless steel

Green Product award

[www.oceanbottle.co](http://www.oceanbottle.co)  
@oceanbottle



SERIOUSLY SUSTAINABLE DRINKWARE

# OCEAN BOTTLE AWARDS



**Green Product Award**

Winner 2020



reddot winner 2020

READY STOCK



## IMPACT

One Ocean Bottle funds the collection of **11.4kg** plastic, equivalent to **1000** plastic bottles.



Sun



Sky



Forest



Ocean



Rock



Black



- > Reusable bottle that funds the collection of 1000 plastic bottles in weight
- > Dishwasher safe
- > 180° twist anti-leak lid with dual opening for drinking and easy cleaning
- > Vacuum stainless steel insulation keeping hot things hot and cold things cold
- > Ice, coffee, tea, juice, smoothies, still and sparkling water — it's all good

READY STOCK

OCEAN BOTTLE

DWOB 291 - Black DWOB 292 - Ocean DWOB 293 - Sun DWOB 294 - Sky DWOB 295 - Forest DWOB 296 - Rock

Our original award-winning 500ml Ocean Bottle keeps cold drinks cold, and hot drinks hot. Made from double wall vacuum-insulated stainless steel and recycled content. The anti-leak dual opening lid makes filling and cleaning a breeze. Plus, unlike most reusable bottles, Ocean Bottle is 100% dishwasher safe.

Available in six colours: Ocean Blue, Rock Grey, Sun Orange, Forest Green, Obsidian Black and Sky Blue.

Print Technique : SC, UV, ENG

Preferred Print Location : Front

Max Print Size : 120 X 25 mm

Product Size : 22 X ø 6.8 cm

Packing Details : 49 X 34 X 27 cm ; 24 pcs / carton ; gw / nw : 10 kg / carton



# BIO BOTTLES MADE IN THE NETHERLANDS

# Tacx

BIO BOTTLES MADE IN THE NETHERLANDS

**Tacx** Are you looking for a bottle fully made of biodegradable materials? Then the Bio-Bottle of Tacx is a great choice. It stands out because the plastic of the bottle is biodegradable. Adding a small amount of bio-material changes the molecular structure so the material finally breaks up in biogas and biomass. This feeds the soil and it's completely absorbed by nature. The process of disintegration starts when the bottle ends up at a microbiological environment (compost heap, waste disposal).



**WB 003**  
Transparent / Aqua Lid  
750CC



**WB 003**  
Silver - 750CC

## Made in THE NETHERLANDS

- Bio Degradable
- 100% Recyclable
- Safe for Food Use
- Screw-On Cap With A Leak Proof Spout
- Secure Grip On Triangular Cap For Easy - Opening And Closing Of Bottle
- Certified Bio-Degradable Water Bottles.
- FDA Approved For Contact With Food.
- OSHA Approved As Non-Hazardous.
- Indefinite Shelf Life.

READY STOCK



**WB 003**  
Transparent / Red Lid 750CC



**WB 003**  
Transparent / Purple Lid 750CC



**WB 003**  
Transparent / Blue Lid 750CC



**WB 003**  
Transparent / Orange Lid 750CC

## Stocks Available



**WB 002**  
Full Red  
500CC



**WB 002**  
Full White  
500CC



**WB 002**  
White/  
Blue Lid  
500CC

Print Technique : UV, SC Preferred Print Location : Center  
Max Print Size : (Flat) 33 x 50 mm, 230 x 50 mm ( Round )  
Product Size 500CC : ø7.7 x 19.6 cm  
Packing Details : 38 x 38 x 39 cm ; 50 pcs /carton ; gw/nw: 4.40 kg / carton



**WB 003**  
Transparent / Pink Lid 750CC



**WB 003**  
Transparent / Grey Lid 750CC



**WB 003**  
Transparent / Royal Blue Lid 750CC



Print Technique : UV, SC  
Product Size 750CC: ø7.7 x 25 cm

Preferred Print Location : Center Max Print Size : (Flat) 33 x 100 mm, 230 x 100 mm ( Round )  
Packing Details : 39 x 39 x 52 cm ; 50 pcs /carton ; gw/nw: 5.5 kg / carton





Stay Hydrated On-The-Go



READY STOCK



Black



- ▶ Vacuum Insulated S.S. bottle
- ▶ Cold for 10 hours, Hot for 5 hours
- ▶ 500 ml Capacity
- ▶ Double Walled Leakproof
- ▶ SS 304 inside SS 201 outside
- ▶ Rubberised Exterior imparts Elegance and Soft Touch



Navy Blue



Grey



White

GRODNO

DWGL 365 - Black DWGL 366 - White DWGL 367 - Grey DWGL 368 - Navy Blue

Rubberized solid colour vacuum insulated stainless steel bottle. The bottle keeps chilled beverages cold for up to 10 hours and hot drinks warm for up to 5 hours. This bottle will keep you hydrated on the go wherever you are. Capacity 500ml, Leakproof, SS 304 inside SS 201 outside

Print Technique : UV, SC, ENG

Preferred Print Location : Front

Max Print Size : 30 x 70mm

Product Size : 26 x ø7 cm

Packing Details : 77.5 X 40 X 30 cms ; 50 pcs / carton ; gw / nw : 17/14 kgs / carton



READY STOCK



- ▶ Designer Water Bottle
- ▶ Stainless Steel, 500 ml
- ▶ Harvested Bamboo Top
- ▶ Wide mouth fits Ice Cubes
- ▶ 8 hours hot 24 hours cold

**DWHL 505 - SENAKI**

Senaki is a stainless steel 500ml water bottle that is beautiful in its simplicity and deliberate in its design. Crafted using sustainable harvested bamboo, stainless steel, and food-grade silicone. Just three materials united into the ultimate expression of sustainable drinkware. The full stainless steel interior keeps your water and other favourite beverages fresh and delicious.

Print Technique : UV, SC, ENG

Preferred Print Location : Front

Max Print Size : 30 x 120 mm

Product size : 28.5 X ø7 cm

Packing Details : 53 x 36 x 29 cm ; 24 pcs /carton ; gw/nw: 12.8/15.0 kg / carton



READY STOCK



450 ml



- > SS 304 Inside, SS 201 Outside
- > Easy Grip, Flat Sides
- > Wide Mouth Fits Ice Cube
- > 12 Hours Cold And 8 Hours Hot
- > Screw-On Cap; BPA Free

GALATI

DWHL 401 - Black   DWHL 402 - White   DWHL 403 - Copper   DWHL 404 - Grey   DWHL 405 - Navy Blue

Hans Larsen™ Galati is the only Stainless Steel reusable water bottle that you will ever need. This water bottle keeps liquids cold for up to 12 hours and hot for upto 8 hours without any sweating on the exterior; plus, a wide-mouth opening allows ice to easily go in and flat-sides offers a secure grip for every sip. Capacity: 450 ml

Print Technique : UV, SC, ENG

Preferred Print Location : Front

Max Print Size : 30 x 120mm

Product Size : 24 x ø7 cm

Packing Details : 54 X 48 X 28 cms ; 30 pcs / carton ; gw / nw : 12 kg / carton



- > 650ml Stainless Steel Bottle
- > Unique Lid With Drink Reminder
- > Leak Proof

READY STOCK

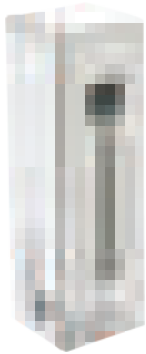

DWXD 817 - AQUA

XDDDESIGN Track your daily hydration goals with this smart designed stainless steel 650ml. water bottle. The lid displays a bigger water drop each time you refill and twist the collar so you can easily keep count of the number of bottles you drink. Handwash only and leakproof. Registered design®

Print Technique : UV, SC, ENG Preferred Print Location : Front  
Max Print Size : (Flat) 30 x 100 mm (Round) 200 x 100 mm Product Size : 20.9 x ø7 cm  
Packing Details : 26.5 x 31 x 46 cm; 24pc /carton; gw/nw: 5.76 kg / carton



Black

Designed by:



Ryan McSorley  
Ireland



reddot design  
award winner



Blue



UI 1270 - BOPP MINI

XDDDESIGN Bopp Mini is a compact 350ml bottle with a matt body and with attached carabiner that makes it easy to clip onto your bag, belt or other gear you take with you. Registered design®

Print Technique : UV, SC, ENG Print Location : Front Down  
Max Print Size : (Flat) 25 x 90 mm (Round) 180 x 50 mm  
Product Size : 18.0 x ø6.4 cm  
Packing Details : 48 x 37x 43 cm ; 60 pcs /carton ; gw/nw: 12 kg / carton





# NEVA STAINLESS STEEL WATER BOTTLE



READY STOCK

Grey/blue

White/Grey

Black/Grey



500 ml



NEVA

DWXD 614 - Grey/blue    DWXD 615 - White/Grey    DWXD 616 - Black/Grey

XDDESIGN® Neva is an alternative in the battle against disposable plastic water bottles. Thanks to the 500 ml body made in durable 304 stainless steel, Neva can be your everyday bottle. The fabric strap allows you to carry the bottle while also serving as a quick release for the leak proof spout. Registered design®

Print Technique : ENG, SC, UV

Preferred Print Location : Center

Max Print Size : (Flat) 25 x 80 mm, 180 x 120 ( Round )

Product Size : 22 x ø6.2 cm

Packing Details : 26 x 47 x 61 cm ; 48pcs /carton ; gw/nw : 10.9 kg / carton



> 550 ml Capacity

> Convenient grip, perfect for running

> Leak proof design



# BOPP SPORT WATER BOTTLE

READY STOCK

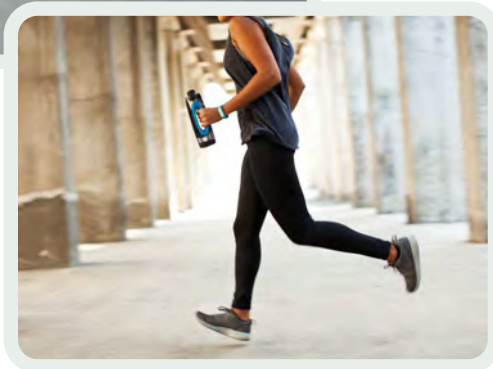
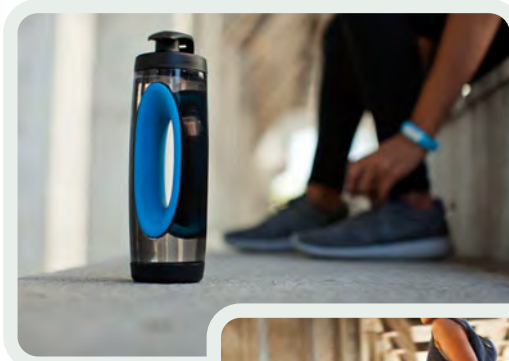

BOPP SPORT

DW XD 602 - Black   DW XD 603 - Blue   DW XD 604 - Red

XDDDESIGN® Bopp Sport is a remarkable sports bottle. The iconic shape gives multiple solutions to carrying the 550ml bottle. The leakproof closure can be easily opened and closed for immediate use. Made of durable Tritan® material. Registered design®

Print Technique : SC, UV   Preferred Print Location: Cap / Front Down   Max Print Size : 35 x 15 mm  
Product Size : 24.1 x ø6.8 cm   Packing Details : 27.5 x 69.5 x 53.5 cm ; 48 pcs /carton ; gw/nw : 14.2 kg / carton



XDXCLUSIVE® | ECO+

**Squared Lockable Leak Proof Tritan Water Bottle**



XDXCLUSIVE® | ECO+

**Honeycomb Lockable Leak Proof Infuser Bottle**



Transparent

Blue

Black

Locking Mechanism



Black

White

READY STOCK



- ▶ Single Handed Operation
- ▶ 600 ml Leak Proof Bottle
- ▶ Locking Mechanism
- ▶ Silicone Border / Sleeve
- ▶ Tritan Bottle; BPA Free



**SQUARED**

DWXD 904 - Black    DWXD 905 - Transparent    DWXD 906 - Blue

XDXCLUSIVE® This unique shaped water bottle with silicone sleeved body allows convenient single-handed drinking. Push the button and the lid flips open. There's a special locking mechanism to keep users away from accidentally pressing the button. This water bottle is made of a durable and innovative tritan material. Odourless and 100% BPA-free. Content 600ml. Registered design®

Print Technique : SC, UV                      Preferred Print Location : All Sides  
 Max Print Size: 40 x 50 mm                  Product Size : 20.7 x 8.8 x 5 cm  
 Packing Details : 24 x 35 x 41.5 cm ; 24pc /carton ; gw/nw: 4.5 kg / carton

- ▶ Single Hand Operation
- ▶ 700 ml Leak Proof Bottle
- ▶ BPA Free ; Tritan material
- ▶ Locking Mechanism
- ▶ Infuser



**HONEYCOMB**

DWXD 901 - Black    DWXD 902 - White

XDXCLUSIVE® Add some healthy fruit flavours to your water. This designer bottle with honeycomb details offers convenient single-handed drinking. Push the button and the lid flips open. There's a special locking mechanism to keep users away from accidentally pressing the button. Including carrying handle. This infuser bottle is made of a durable and innovative tritan material. Odourless and 100% BPA-free. Content 700ml. Registered design®

Print Technique : SC, UV                      Preferred Print Location : Side  
 Max Print Size: 30 x 40 mm                  Product Size : 24.8 x ø8.6 cm  
 Packing Details : 28 x 36.5 x 53.5 cm ; 24pc /carton ; gw/nw: 5.5 kg / carton



Unique Lid Displays Amount Of Water Consumed & Re-filled For Easy Tracking

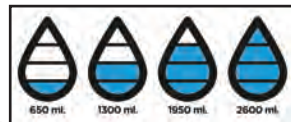

600ml Tritan Bottle

Unique Lid With Drink Reminder

Leak Proof

Blue

Transparent

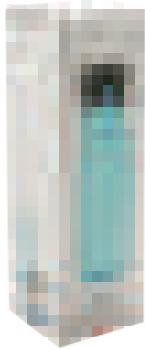

AQUA TRITAN

DWXd 827 - Blue DWXd 829 - Transparent

XDDDESIGN Track your daily hydration goals with this cleverly designed 600 ml tritan water bottle. The lid displays a bigger water drop each time you refill and twist the collar so you can easily keep count of the number of bottles you drink. Handwash only & Leakproof.

Print Technique : UV, SC, DOM Preferred Print Location : Front  
Max Print Size : (Flat) 25 x 80 mm (Round) 200 x 100 mm Product Size : 23 x ø7 cm  
Packing Details : 26 x 32 x 47 cm ; 24pc /carton; gw/nw: 4.9 kg / carton

Transparent / Anthracite

Black / Anthracite



600ml Lockable Tritan Bottle

Leak Proof

Single Handed Operation

HYDRATE BOTTLE

DWXd 910- Transparent / Anthracite DWXd 911 - Black / Anthracite  
XDXCLUSIVE Leak proof lockable tritan bottle with handle. Content: 600ml. Registered design®

Print Technique : UV, SC, Preferred Print Location : Front  
Max Print Size : (Flat) 25 x 80 mm (Round) 200 x 100 mm Product Size : 23.4 x 7.2 cm  
Packing Details : 27 x 26 x 59 cm ; 21pc /carton; gw/nw: 4.25 kg / carton

READY STOCK





Hans Larsen™  
Drinkware



- > TRITAN™ Body
- > 800ml ; Leak Proof
- > Single Hand Operation

DWHL 506 – BATUMI

*Hans Larsen* Trendy infuser bottle to flavour your water with your favourite fruit or herbs. The body is made out of TRITAN™ material so it is scratch proof and durable. The lid is made out of ABS and is leakproof so you can take your flavoured water wherever you go. Capacity 800 ml.

Print Technique : UV, SC Preferred Print Location : Front  
Max Print Size : (Round) 33 x 160 mm (Flat) 220 x 150 mm  
Product Size : 27.9 x ø7.6 cm  
Packing Details : 47 x 32 x 59.5 cm ; 50pc/carton; gw/nw: 14 kg / carton

**Tacx**

BIO BOTTLES MADE IN THE NETHERLANDS



- > Food Approved, Free Of BPA And Phthalates
- > Dishwasher Safe
- > Recyclable Plastic
- > 20% Post Industrial Recycled Plastics
- > All Caps Are Fitted With Lockable Pull Lids
- > Easy To Squeeze; Made From Soft Plastics
- > Large Opening, Easy To Clean
- > Dutch Design

READY STOCK



FUSE

DWTX 501 - Black DWTX 502 - Light Blue DWTX 503 - Dark Blue DWTX 504 - Red

**Tacx** The Fuse bottle is a squeezable elegant life style bottle with a fruit fusion stick. Add taste and vitamins to your water by threading pieces of fruit or herbs onto the fruit fusion stick. The bottle holds 450cc, is made from soft squeezable BPA free polyethylene and has a pull lid for easy drinking. A carry on handle helps carry it around for various sports activities.

Print Technique : UV, SC Preferred Print Location : Front  
Max Print Size : 198 x 147 mm (Round) Product Size : 23 x ø6.4 cm  
Packing Details : 32.5 x 32.5 x 46.3 cm ; 50 pcs /carton ; gw/nw: 9.78 kg / carton



# FRUIT INFUSERS

**XD** COLLECTION

Black

Blue

500 ml



- > Leakproof
- > Innovative Infuser Part
- > Tritan Material
- > Convenient Size
- > Healthy Gift



EVERYDAY

DW XD 833 - Black    DW XD 834 - Blue

**XD** Leak proof infuser bottle. Add vitamins and flavour to your drink by adding fresh fruit. In the top of the bottle is a special infuser cap which gives a smooth water flow and holds your fruit inside the bottle. Hand-wash only. Content 500 ml.

Print Technique : UV, SC

Preferred Print Location : Front

Max Print Size : (Flat) 140 x 30 mm (Round) 75 x 130 mm

Product Size : 19.5 x ø6.3 cm

Packing Details : 42 x 34 x 40 cm; 60 pcs/carton; gw/nw: 6.1 kg/carton

**Giftology**

680 ml

**ALL THE REDS**

**Hans Larsen™**  
Drinkware



DWGL 403 - HAGEN

DWGL 303 - AACHEN

**Giftology** 680ml water bottle with fruit infuser compartment. Infuse your water with fresh fruits and additional flavours into the infuser compartment. The infuser compartment can also be used to chill your water by adding ice cubes. Also prepares your detox water and enjoy the infusion.



800 ml



DWHL 203 - INFUS

**Hans Larsen™** Infus is a 800ml Tritan bottle with fruit infuser compartment. Infuse your water with loads of vitamins and flavour by adding fresh fruits into the infuser compartment. The infuser compartment can also be used to chill your water by adding ice cubes.

READY STOCK



680 ml

HAGEN

DWGL 401 - Black

**Giftology** 680ml water bottle with fruit infuser compartment. Infuse your water with fresh fruits and additional flavours into the infuser compartment. The infuser compartment can also be used to chill your water by adding ice cubes. Also prepares your detox water and enjoy the infusion.

Print Technique : UV, SC

Preferred Print Location : Front

Max Print Size : (Flat) 140 x 30 mm (Round) 75 x 130 mm

Product Size : 25.2 x ø7.5 cm

Packing Details : 47x 39.5 x 54 cm; 60 pcs/carton; gw/nw: 13.5 kg/carton

**Hans Larsen™**  
Drinkware

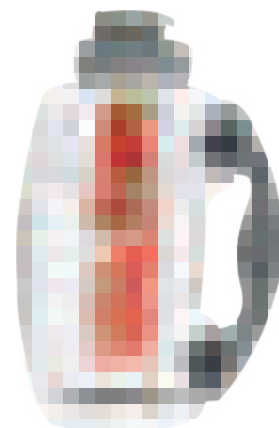

DWHL 225 - INFUJUG

**Hans Larsen™** Enjoy flavor-infused beverages made naturally at home with the 1.8 litre InfuJug Fruit Infusion Pitcher. This BPA-free PET pitcher has removable hollow rod that can be filled with fruits, citrus wedges, herbs, or savories. Open slots in rod allow contents to naturally combine with liquid; rod screws into lid, so it stays securely in place.

Print Technique : SC, UV

Preferred Print Location : Front Top

Max Print Size : 30 x 50 mm    Product Size : 27 x 9 x 19 cm

Packing Details : 57 X 55 X 30 cm; 15 pcs/carton; gw/nw: 6.4 kg/carton

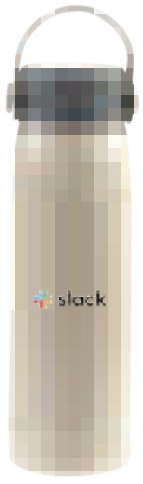
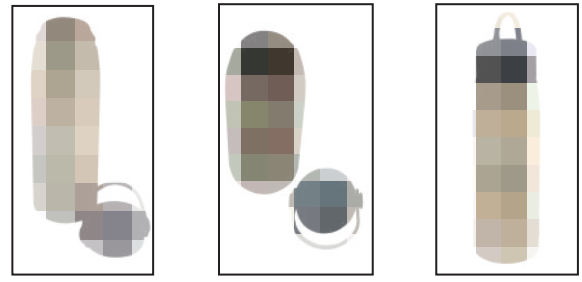

- Glass Inside
- ECO Wheat Straw Exterior
- Phone Stand
- 380 ml Bottle with carry handle



Mobile Stand

DWGL 361 - RABI

**eco-neutral** Eco Friendly water bottle with glass interior and wheat straw exterior. With convenient handle for easy carrying and a phone stand at the base. Capacity 380ml. BPA free. Packed in a gift box.

Print Technique : UV, SC, ENG  
Product Size : 21 x ø6.3cm

Preferred Print Location : Front    Max Print Size : (Flat)30 X 100 mm; (Round) 100 X 190 mm  
Packing Details : 56 x 35.5 x 23.5 cm; 40 pcs /carton; gw/nw: 13/12 kg / carton

READY STOCK



Made from natural fast growing bamboo and 100% recyclable borosilicate glass, this reusable bottle is designed to support the environment.

- Borosilicate Glass Body & Eco Bamboo Top Cap
- Silicon Sleeve For Protection
- Eco-Friendly !!



DWHL 502 - MEGARA

**Hans Larsen** Megara is made from glass that is 100% recyclable and that doesn't infuse harmful chemicals or unwanted flavours into your water like plastic or metal and eco-friendly bamboo lid. Made from high grade borosilicate glass, which is more heat resistant than any other commonly used glass. Now you can save the planet and enjoy your warm tea too. With fashionable silicone sleeve for drop protection and heat insulation. Content 550ml.

Print Technique : UV, SC, ENG  
Product Size : 24 x ø6.8 cm

Preferred Print Location : Top    Max Print Size : 45 x 40 mm  
Packing Details : 49 X 33 X 26 cm; 24 pcs/carton; gw/nw: 14.5 kg/carton



# WATER BOTTLES



DWHL 254 - MONZA

*Hans Larsen™* 500 ml Double Walled Vacuum water bottle with UV-C steriliser that kills up to 99.9% of the bacteria in the drink inside the bottle. You can choose to do a quick clean in 3 min sterilization or a complete clean 5 minute sterilization. For protection, the UV-C light automatically switches off once the lid leaves the bottle. With a 400 mAh battery, the UV-C light can work for 2.5 hours or 50 regular sterilizations. The bottle keeps a drink hot for 12 hours and cold 24 hours.

Print Technique : UV, SC, ENG Preferred Print Location : Front Max Print Size : (Flat)35 X 100 mm; (Round) 100 X 200 mm  
Product Size: 24.4 x ø6.4cm



UV-C in action



UV-C Light Source

*Hans Larsen™*



READY STOCK



Red

White

GRUENE

DWMK 101 - White DWMK 103 - Red

420ml capacity glass bottle with protective neoprene sleeve in bright tones. With screw-on safety cap and carrying belt.

Print Technique : SC, UV Preferred Print Location : All over  
Max Print Size : 60 x 50 mm Product Size : 19 x ø6.4 cm  
Packing Details : 40 x 37 x 37cms; 50pc /carton; gw/nw: 14 kg / carton



*Hans Larsen™*



- Made From Borosilicate Glass
- 500 ml; Heat Resistant
- Sleeve Included For Drop Protection



DWHL 351 - BRASOV

*Hans Larsen™* Time to purify your lifestyle, and change the way you drink water. Glass is 100% recyclable and doesn't contains harmful chemicals or unwanted flavours into your water like plastic or metal. Brasov water bottle is reusable and is entirely BPA free, lead free and worry free. Made from high borosilicate glass, which is more heat resistant than any other commonly used glass. With fashionable sleeve for drop protection and heat insulation. Content 500 ml.

Print Technique : SC, UV Preferred Print Location : Bottle  
Max Print Size : (Flat) 25 x 120 mm, (Round) 70 x 120 mm Product Size : 21.6x ø6.7 cm  
Packing Details : 49 x 33 x 26.5 cm; 24pc /carton; gw/nw: 11 kg / carton

# DOUBLE WALLED VACUUM FLASK



Black

READY STOCK



- 4 Attractive Colors
- 500 ml Capacity
- Top Part For Engraving Logo
- Food Grade



Green



Blue



White



EGALEO - Stainless Steel Vacuum Flask

DWHL 256 - Black DWHL 257 - White DWHL 258 - Blue DWHL 259 - Green

Double walled Flask with capacity 500ml (gross), 470ml (net). Material - Stainless steel (SS 304 inner, SS 201 outer). Keeps drinks hot for 8 hours, cold for 12 hours. Food Grade

Print Technique : SC, UV, ENG  
Product Size : ø6.5 x 22.5 cm

Preferred Print Location : Front & Top      Max Print Size : (Front) 60 x 50 mm (Top) ø45 mm  
Packing Details : 73 X 37 X 25 cm ; 50 pcs / carton ; gw / nw : 15/14 kgs / carton



# DRINKWARE

# Hans Larsen™

## Hans Larsen™ Drinkware

Silver



Black



500 ml / 160z Capacity



Geometric Design

Double Walled Flask To Keep Drink Hot Or Cold For Longer Time



BPA Free , Leak Proof

FLAOG

DWHL 301 - Black DWHL 302- Silver

Hans Larsen™ Flaog is a 500ml double walled flask with matt body and vacuum insulation. Made of Durable 304 Stainless Steel inside & 201 outside with vacuum insulation in between which keeps your drink cool or hot for longer hours. The shiny geometric design creates an illusion of different shades in the presence of light which gives it a trendy look; It also gives a good grip to hold the flask.

Print Technique : UV, SC, ENG

Preferred Print Location : Front

Max Print Size : 60 x 30 mm (Flat) 60 x 210 mm (Round)

Product Size : 26 x ø7 cm

Packing Details : 61 x 39 x 29 cm; 39 pcs/carton; gw/nw: 16 kg/carton

READY STOCK



## Hans Larsen™ Premium Drinkware



DWHL 503 - VODICE

Hans Larsen™ Vodice is a 500 ml double walled vacuum flask with a screw-on plastic drinking cup and a silicon loop. Toggle switch ensures easy open / close operation. Made from SS 204 outside and SS 304 inside. The metal plate on top allows for excellent personalization of your logo. Packed in a gift box.

Print Technique : UV, SC, ENG

Preferred Print Location : Top

Max Print Size : ø45 mm

Product Size : 7.9 X 7 X 25.2 cm

Packing Details : 31 X 32 X 50 cm ; 30 pcs / carton ; gw / nw : 13 kg / carton

Leak Proof

FDA Compliant



DWHL 501 - LEDNICE

Hans Larsen™ Lednice is a 480 ml/16 Oz stainless steel water bottle, food safe and FDA and LFGB compliant. Packed in a gift box.

Print Technique : UV, SC, ENG

Preferred Print Location : Front

Max Print Size : 60 x 50 mm

Product Size : 17 x ø8.5 cm

Packing Details : 42 X 42 X 32 cm ; 50 pcs / carton ; gw / nw : 10.80 kg / carton



READY STOCK



- > Copper Vacuum Construction
- > Powder Coated Finish
- > Double Wall 18/8 Grade Steel
- > Leak Proof
- > 8 Hrs Hot, 24 Hrs Cold



DWSW 101 - 1 L

DWSW 102 - 0.5 L



**DWSW 101 - ELITE COPPER VACUUM FLASK, 1L**

**SWISS PEAK®** The Swiss Peak Elite series are with vacuum insulation and double wall 18/8 grade stainless steel. The powder coated black colour is built to last! No fading or cracking here! The inner wall is plated with copper for ultimate conductivity to keep drinks hot for 8 hours and cold for 24 hours. Hand washable and leakproof. Content 1000 ml.

Print Technique : UV, SC, ENG Preferred Print Location : Front

Max Print Size : 35 X 110 mm Product Size: 32.6 X ø8.7cm

Packing Details : 36 X 40 x 59.50 cm ; 24 pcs / carton ; gw / nw : 17kg / carton

**DWSW 102 - ELITE COPPER VACUUM FLASK, 0.5 L**

**SWISS PEAK®** The Swiss Peak Elite series are with vacuum insulation and double wall 18/8 grade stainless steel. The powder coated black colour is built to last! No fading or cracking here! The inner wall is plated with copper for ultimate conductivity to keep drinks hot for 8 hours and cold for 24 hours. Hand washable and leakproof. Content 500 ml.

Print Technique : UV, SC, ENG Preferred Print Location : Front

Max Print Size : 30 X 110 mm Product Size: 25.5 X ø7.4 cm

Packing Details : 55 x 27 x 34.5 cm ; 24 pcs / carton ; gw / nw : 13kg / carton



READY STOCK

300 ml



Black

Silver

- BPA FREE
- Double Wall
- LEAK PROOF

- > Trendy Geometric Design
- > Durable 201 Stainless Steel

MOSA TUMBLER  
 DWXD 718 - Silver DWXD 719 - Black  
 XDDESIGN® Mosa is a fashionable 300ml tumbler from durable 201 stainless steel with an inside PP lining. Registered design®  
 Print Technique : UV, SC, ENG Preferred Print Location : Front Bottom  
 Max Print Size : (Flat) 25 x 50 mm (Round) 200 x 50 mm  
 Product Size : 15.5 x ø7 cm  
 Packing Details : 53 x 42 x 36 cm ; 60 pcs/carton; gw/nw: 13.35 kg / carton

500 ml



Black

Silver

- BPA FREE
- Double Wall
- LEAK PROOF

- > Trendy Geometric Design
- > Durable 201 Stainless Steel

MOSA FLASK  
 DWXD 820 - Black DWXD 821 - Silver  
 XDDESIGN® Mosa is a fashionable 500ml double wall vacuum flask in durable 201 stainless steel. The flask closes with a PP lid that can be used to enjoy your hot beverages. Registered design®  
 Print Technique : UV, SC, ENG Preferred Print Location : Front Bottom  
 Max Print Size : (Flat) 25 x 80 mm (Round) 200 x 80 mm  
 Product Size : 23.5 x ø6.9 cm  
 Packing Details : 28.0 x 41.0 x 53.0 cm ; 30 pc; 6pcs /carton ; gw/nw: 12.7 kg / carton





XD COLLECTION



- > 400ml Mug With Cork Sleeve
- > Dishwasher & Microwave Safe
- > Made From PLA Without Plastic
- > Bio Degradable & Environment Safe

DWXD 918 - ECO PLA

**XD COLLECTION** An ECO mug made from PLA without plastic. BPA-free with no toxic chemicals or plastics. Reusable, biodegradable and compostable. Truly sustainable and safe for those who care about their health and the environment. Heat resistant up to 120 degree Celsius, microwave safe and dishwasher safe (top rack). Spillproof. Content : 400 ml.

Print Technique : UV, SC Preferred Print Location : Right and Left Sides  
 Max Print Size : 25 X 10 mm Product Size : 15.1 X ø7.7 cm  
 Packing Details : 37.5 X 35.5 X 35.5 cm ; 32 pcs / carton ; gw / nw : 5.5 kg / carton



Black

Hans Lassen™  
Premium Drinkware



White



Grey

- > Double Wall Stainless Steel Tumbler / Mug
- > Designed To Fit Coffee Machines
- > Hot: 5 Hrs. Cold: 15 Hrs



GOUDA

DWHL 508 - Black DWHL 510 - White DWHL 511 - Grey

**Hans Lassen™** Vacuum insulated cork coffee mug with unique cork detail. 304 SS inside and 201SS outside. Keeps your drinks hot for up to 5h and cold up to 15h. Fits most coffee machines. Content: 180ml.

Print Technique : UV, SC, ENG Preferred Print Location : Front  
 Max Print Size : 30 X 60 mm (Flat) 200 X 50 mm (Round)  
 Product Size : 10 X ø7.2 cm  
 Packing Details : 57 X 34 X 25 cm ; 56 pcs / carton ; gw / nw : 10.1 kg / 8.1 carton

READY STOCK



CUPGO

DWEN 201 - Blue

- > 270 ml Capacity
- > Eco-Friendly Bamboo Fibre Cup
- > Dishwasher Safe
- > Silicone Lid & Sleeve

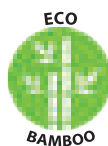

eco-neutral

**eco-neutral** Cupgo is a 270ml mug that is made from naturally grown organic bamboo fibre. It is ecofriendly, reusable & highly durable. The silicon grip with geometric design helps hold the cup conveniently when the drink is hot. Dishwasher safe.

Print Technique : UV, SC Preferred Print Location : Front Max Print Size : 20 x 15 mm  
 Product Size : 12 x ø8 cm Packing Details : 44.5 x 35.5 x 52 cm ; 80 pcs/carton ; gw/nw: 11.80 kg/carton



# MUGS

## XDDESIGN®



Designed by :



Antoine  
France



Orange

- Fresh Colors
- Designer Drinking Mug

UI 1261 - URBAN

XDDESIGN Urban is a 400ml metal exterior mug which is ideal to use on your desk and to enjoy your coffee or tea. Stainless steel exterior has young & rich colors to add to the experience. Keeps your drink Hot for 3 Hrs & Cold for 6 Hrs. Registered design®

Print Technique : UV, SC

Preferred Print Location : Center

Max Print Size : ( Flat ) 30 x 70 mm

Product Size : 15.5 x 8.0 x 11.5 cm

Packing Details : 55.5 x 51.5 x 39 cm ; 40 pcs /carton ; gw/nw: 12.1 kg / carton

READY STOCK

XDXCLUSIVE® | ECO



Black/ Anthracite

Silver / Black



- 280ml Leak Proof Vacuum Tumbler
- 5 Hours Hot And 15 Hours Cold

SIERRA

DWXD 913- Black/ Anthracite DWXD 914- Silver / Black

XDXCLUSIVE® Just the right size, a perfect fit for most coffee machines. This vacuum insulated double wall stainless steel design tumbler with silicone band detail. Keeps your drink hot for up to 5 hours and cold for up to 15 hours. Content: 280ml. Registered design®

Print Technique : UV, SC, ENG

Preferred Print Location : Front

Max Print Size : (Flat) 25 x 60 mm (Round) 200 x 80 mm

Product Size : 13.7 x 7.3 cm

Packing Details : 31 x 41 x 41 cm ; 50pc /carton; gw/nw : 10.25 kg / carton



BOGOTA

DWXD 915 - Black

XDXCLUSIVE® Don't taste your mug, just taste your drink! Enjoy this ceramic drinking experience. Keeps your drink hot for up to 5 hours and cold for up to 15 hours with this vacuum insulated tumbler. A ceramic all-over coating has been applied on the inner wall in order to have a better drinking experience and eliminate the metallic taste. Leak proof lid. Content: 500ml. Registered design®

Print Technique : UV, SC, ENG

Preferred Print Location : Front

Max Print Size : (Flat) 25x 80 mm (Round) 200 x 100 mm

Product Size : 20 x ø7.1 cm

Packing Details : 23.5 x 40 x 48 cm; 30pc /carton; gw/nw: 9.1 kg/carton

- 500ml Leakproof Vacuum Tumbler
- Ceramic Coated Inner Wall
- 5 Hours Hot And 15 Hours Cold
- Ceramic Coating Prevents Foul Odour

- ▶ 250 ml Leak Proof Mug
- ▶ One Hand Operation
- ▶ Lockable Lid
- ▶ Can Be Completely Disassembled By Recycling



LOCK MUG

DWXD 722 - Blue DWXD 723 - Green

XDDDESIGN® Lock allows you to safely drink and transport your drink to any location. The 250ml mug is easy to lock with one hand and made from durable 201 stainless steel with an inside PP lining. Designed in away that the mug is easy to take apart for recycling. Registered design®

Print Technique : UV, SC, ENG Preferred Print Location : Front Max Print Size : ( Flat ) 25 x 90 mm, ( Round ) 195 x 120  
 Product Size : 6.8 x 8.1 x 20 cm Packing Details : 42 x 52.5 x 24.5 cm ; 30 pcs/carton; gw/nw: 2.5 kg / carton



Scan Below QR code to watch product video



- ▶ 227 ml; Double Walled
- ▶ Easy To Clean
- ▶ Leak Proof
- ▶ Fits Under Your Coffee Machine



READY STOCK

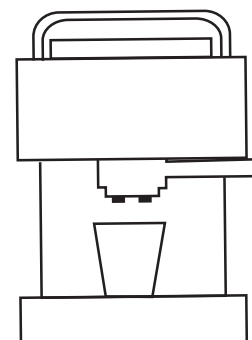

 Your ideal coffee partner

DIA

DWXD 501 - Black DWXD 502 - White DWXD 503 - Red DWXD 504 - Blue DWXD 505 - Lime

XDDDESIGN® Closable, insulated and compact enough for under the coffee machine (227 ml). It is also very hygienic because the lining of the mug is made of stainless steel and not from plastic. Designed to be completely dismantled at the end of its life-cycle. Registered design®

Print Technique : UV, SC, ENG Preferred Print Location : Center Max Print Size : ( Flat ) 25 x 60 mm, 170 x 60 mm ( Round )  
 Product Size : 8.5 x 9.2 x 10.2 cm Packing Details : 54 x 40 x 39.5 cm ; 50 pcs/carton ; gw/nw: 13.7 kg / carton



# MUGS



READY STOCK

### Hans Larsen™

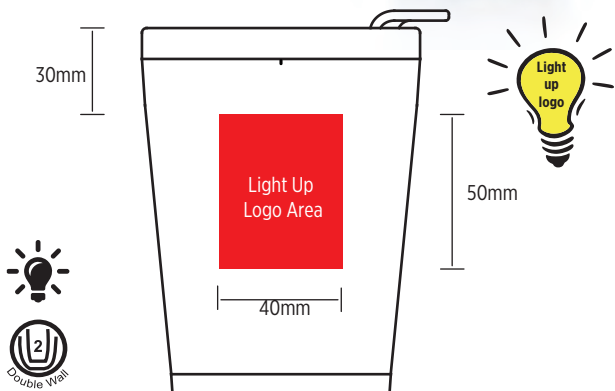

DWHL 509 - HENGLO

Hans Larsen™ Double wall tumbler. 304 SS inside and ABS plastic outside. Engrave your logo and when you pick up the bottle, logo on tumbler will light up for optimal brand exposure. Including 2 CR2032 cell battery. Content: 280 ml. Fits most coffee machines.

Print Technique : UV, SC, ENG Preferred Print Location : Front  
Max Print Size : (Light-Up logo) 40 x 50 mm Product Size : 10 x ø7.2 cm  
Packing Details : 39.5 X 30 X 29.5 cm ; 24 pcs / carton ; gw / nw : 6.6 kg / carton

### XDDESIGN®



Coffee to go tumbler without handle



DWXD 815

- Convenient Small Size, 160ml
- Fits Most Coffee Machines
- Spill-Proof Lid



Coffee to go mug with handle



Silver



BEVAGE

DWXD 811 - Black DWXD 812 - Silver DWXD 815 - Silver

XDDESIGN® With 8 cm height, this is the perfect double wall mug for your coffee machine. PP inner. Great for your Espressos and Cappucinos. Easy twist spill proof lid. Hand washable only. Content 160ml. Registered design®

Print Technique : UV, SC, ENG Preferred Print Location : Front  
Max Print Size : 25 x 20 mm Product Size : 10.0 x ø7.0 cm  
Packing Details : 26.0 x 34.0 x 54.5 cm ; 40pc/carton ; gw/nw : 6.16 kg / carton

**XDDDESIGN<sup>®</sup>**



- > Double Walled ; 275 ml
- > Stylish & Trendy
- > Excellent Branding Space

POP MUG

DWXD 710 - Black DWXD 711 - White

XDDDESIGN<sup>®</sup> Pop is a fresh looking double wall plastic mug with frosted outside and sliding lid. 275ml content. Registered design<sup>®</sup>  
 Print Technique : SC, UV Preferred Print Location : Front Max Print Size : ( Flat ) 20 x 90 mm ( Round ) 185 x 70 mm  
 Product Size : 16.9 x 7.2 x 10.3 cm Packing Details : 42 x 69 x 39 cm ; 60 pcs/carton; gw/nw : 14.5 kg/carton

**Hans Larsen<sup>™</sup>  
Drinkware**

\* Image for representation purpose only. Do not try.



- > 470 ml Anti-Spill Mug
- > Leak Proof Design
- > Double Walled
- > Anti-Fall Suction Base



EUNOIA

DWHL 205 - All White DWHL 206 - White-Blue Lid DWHL 207 - White-Grey Lid DWHL 208 - White-Black Lid

Hans Larsen<sup>™</sup> 470 ml Double walled suction mug with outer body made from BPA free ABS and inside made from high grade stainless steel (SS 304) to ensure that your drink maintains its temperature for a long time. Strong vacuum suction pad at the bottom ensures that the mug holds firmly to the surface on which it is placed. Never worry about the drink spilling on to your table because it does not fall! Leakproof lid allows you to keep the mug in the bag, on your car seat, anywhere!  
 Print Technique : UV, SC Preferred Print Location : Center Max Print Size : ( Flat ) 30 x 140 mm, 160 x 32 mm ( Round )  
 Product Size : 22 x ø8.5 cm Packing Details : 45.5 x 45.5 x 24.5 cm; 25 pcs/carton; gw/nw: 10 kg/carton

READY STOCK

**Hans Larsen<sup>™</sup>  
Drinkware**



- > Designed In Japan
- > 280 ml Spill-Free Tumbler
- > Inspected For Food - Hygiene
- > Can Resist A Drink Of Upto 80°C



**Spill-Free**



DWHL 251 - SISAK

Hans Larsen<sup>™</sup> Sisak is a double walled, 280ml anti-spill thermo tumbler which is inspected for food-hygiene, hence makes it very safe compared to regular plastic tumblers. It can resist a temperature of upto 80°C without your tumbler getting hot. The stylish lid does not allow the drink to spill out of the tumbler even when the tumbler falls down.

Print Technique : UV, SC Preferred Print Location : Front Max Print Size : ( Round ) 190 x 95 mm ( Flat ) 25 x 80 mm  
 Product Size : 14 x ø7.2 cm Packing Details : 42x 42 x 32 cm; 50 pcs/carton; gw/nw: 10.8 kg/carton



# HAPPY MUGS & SUBLIMATION MUGS



DUBLIN  
DWMK 104 - Heart DWMK 105 - Sunglass DWMK 106 -Wink DWMK 107 -Smile  
370ml, ceramic mug with fun emoji designs in eye-catching yellow color. Presented in an individual box.  
Print Technique : SC, UV Preferred Print Location : Front Max Print Size : 38 x 60 mm  
Product Size: 8.2 x 9.8 cm Packing Details : 33 x 27.5 x 48 cms ; 36 pcs / carton ; gw / nw : 13 kg / carton

## OUTER WALL OF MUG CHANGES FROM BLACK TO WHITE

## COLOR CHANGING MUG

WHEN HOT BEVERAGE IS ADDED, REVEALING LOGO.

READY STOCK



DWLC 902 - SALTA  
11 OZ Colour changing sublimation mug with matt finish



DWLC 901 - PARANA  
11 OZ Sublimation mug



DWLC 201 - KAHVE  
11 OZ ( 325ml ) Ceramic Mug With Matt Finish



Blue



White



Cream



Grey

**COLOR LOOP HORIZON MUG**

**HLVB 103** - White **HLVB 104** - Cream **HLVB 105** - Grey **HLVB 106** - Blue

Mug with a clean and flowing contour. Refined grey, sand and blue shades and a rough surface texture lend it an original, very special charm. Dishwasher and Microwave safe.

**READY STOCK**



**HLVB 107 - SIMPLY FRESH COFFEE MUG**

Beautiful does not always have to be different. Or does it? Or not? Or rather classic? This beautiful 350ml Simply Fresh mug allows for both. It combines simple elegance with fresh design. Dishwasher and Microwave safe.



**HLVB 108 - BASIC WHITE COFFEE MUG**

Basic white 300ml mug MADE IN GERMANY with elegant design in versatile classic white. These mugs are a perfect office desk companion. Dishwasher and Microwave safe.



# SUBLIMATION MUGS AND BOTTLES



DWLC 929 - ENNS  
14 OZ Stainless steel mug.



DWLC 930 - MELK  
14 OZ Stainless steel mug.

READY STOCK



DWLC 928 - LEOBEN  
14 OZ Stainless steel mug with white patch for full color digital printing.



White



Silver

GUNSAN  
DWLC 961 - White DWLC 962 - Silver  
600 ml Alluminium water bottle.



UI 1327 - White / Blue  
Ceramic Mug White with Blue silicone lid & grip  
325 ml capacity





**AN INTELLIGENT MUG WARMER & PHONE WIRELESS CHARGER**  
use @ home, in office.



READY STOCK



Reinforced Porcelain



Neither wireless charging nor heating coil switches on accidentally due to foreign objects

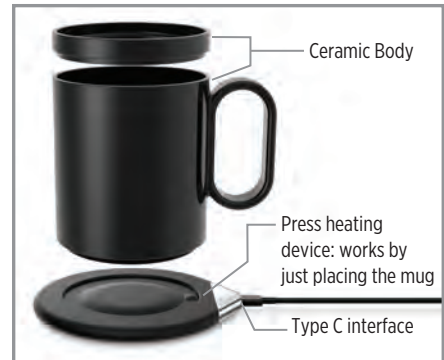

- > Material- High Temperature-Safe on touching while ON
- > Continuous 8 hours working
- > Mug 350ml
- > Constant temperature 55°C
- > Supports Qi standard wireless charging of phones incl. Apple & Android upto 10W.



Intelligent Foreign object Recognition identifies metal items that are accidentally place in panel



Wireless / Heating panel is waterproof

CRIVITS

ITHL 534 - WIRELESS CHARGER CUM CUP WARMER

Hans Larsen™ Works with own cup / mug only as effectice contact points work in tandem with each other. This intelligent base recognises metal foreign objects placed accidentally and are not meant to be warmed or charged, Panel is waterproof & touch safe while on. The radio bottom cooling sheet dissipates heat at high temperature & accumulates heat when temperature is low, Mode of heating - wireless induction.

Print Technique : SC, UV

Print Location : Plate & Front of Mug Max Print Size : (Plate) 10 x 10 mm

Product Size : ø8.5 x 10.5 cm

Packing Details : 59 X 41 X 35 cm; 24 pcs/carton; gw/nw: 19.5/18.5 kgs /carton

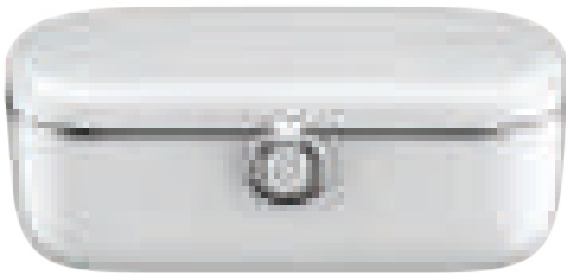

READY STOCK

This Electric Lunch Box is in conformity with the technical requirements of the following standards:

EN60335-2-15:2016+A11:2018

EN60335-1:2012+AC:2014+A11:2014+A13:2017

+A1:2019+A14:2019+A2:2019

EN62233:2008

EN55014-1:2017/A11:2020

EN55014-2:2015

EN IEC 61000-3-2:2019

EN 61000-3-3:2013/A1:2019



- > Maintains your lunch at a constant temperature
- > A Daily-use quality product for everyone
- > Can print individual names on top & company logo on front
- > Quality confirms to European safety & quality requirements
- > Choice of 2 fast-moving colors

CAZMA

ITLB 531 - Black ITLB 532 - White

Hans Larssen™ Electric Lunch Box continuously keeps your food warm at a constant temperature until you are ready to eat. When you gift CAZMA electric lunch box your logo is right in front of the eyes of the recipient & his / her family. This gift will create goodwill for your brand, continuously as it will get used over a long time period.

Print Technique : (Top) DM, (Side) SC Preferred Print Location : Top & Side Max Print Size : (Top) 5 x 20 mm (Side) 15 x 100 mm

Product Size : 22.1 x 13.5 X 8.5 cm Packing Details : 48.8 x 45.6 x 47.2 cm; 24 pcs/carton; gw/nw: 19.6 kg/carton



Black



White

READY STOCK



- > S.S. Flask- SS 304 Inner  
SS 201 Outer
- > Food Grade: 8 hours hot,  
12 hours cold

MEPPEN

GSGL 499 - Black GSGL 500 - White

Set of Stainless Steel Vacuum flask and A5 Notebook in an elegant set box

(Flask) Print Technique : SC, UV, ENG

Preferred Print Location : Front & Top

Max Print Size : (Front) 60 x 50 mm (Top) ø45 mm

(Notebook) Print Technique : SC, UV

Preferred Print Location : Bottom center

Max Print Size : 140 x 205 mm

Product Size: (Flask) ø6.5 x 22.5 cm (Notebook) 13 x 21 x 1.4 cm

Box Size: 14 x 24.5 x 8.3 cm



# ECO GIFT SET

## Useful eco-conscious gift set with sustainable packaging:

**Notebook** - Kraft cover with FSC-certified paper inside

**Mug** - Wheatstraw material with silicone sleeve

**Pen** - Made with wheatstraw material

**VALUE**

READY STOCK



Wheatstraw Mug w/ silicone



Notebook with FSC paper



Wheatstraw Pen

- > All products plus packaging from sustainable materials
- > Silicone sleeve helps hold mug with hot liquid
- > 80 pgs Notebook - 14 x 9 cm, 70 gsm
- > Give VALUE, Save Ecology when you give out this set
- > 380 ml Mug capacity



GSEN 681 - KORGAN

(Notebook) Print Technique : SC, UV

(Pen) Print Technique : SC, UV

(Mug) Print Technique : SC

Box Size: 14.5 x 10.3 x 9.7 cm; Each set of 3 in box weighs 176 gms

Preferred Print Location : Front

Preferred Print Location : Clip

Preferred Print Location : Front

Max Print Size : 70 x 130 mm

Max Print Size : 7 x 35 mm

Max Print Size : 30 x 50 mm



READY STOCK



➤ Bamboo & Packaging-  
sustainable

Set of Eco Lunch Box & Vacuum Bottle  
GSHL 180 - CHAVES

Hans Larsen® (BOTTLE) Double wall stainless steel insulating vacuum flask with bamboo lid and carry handle. Capacity: 500 ml. Leak Proof Material- SS 304 Inside SS 201 Outside.  
(LUNCH BOX) Stainless Steel lunchbox with bamboo lid and 2 cutlery utensils with attachable polyester band. Capacity 700ml. Bamboo is a natural product, there may be slight variations in colour and size per item. Material- SS 304 Food Grade

(BOTTLE) Print Technique : SC, UV, ENG Preferred Print Location : Bottle Front & Top  
(LUNCH BOX) Print Technique : SC, ENG Preferred Print Location : Lunch Box Top & Side  
Box Size : 25.5 x 25.5 x 7.5 cm; Box with both items weighs 715 gms

Max Print Size : (Front) 30 x 40 mm (Top) ø 45 mm  
Max Print Size : (Top) 90 x 30 mm (Side) 30 x 100 mm





READY STOCK



- > Flask Capacity 600ml
- > Tumbler Capacity 180ml

ALMELO

GSHL 102 - Black GSHL 103 - Silver

For a daily fix of coffee even when you are running late, and a much-needed water break when you are out doing something or the other, this Flask and Tumbler Gift Set comes in very handy. Perfect for wherever and whenever, this SS 304 insulated flask & tumbler series keeps cold drinks cool and hot drinks warm.

Print Technique : UV, SC, ENG

Preferred Print Location : Front

Max Print Size : (Flask) (Flat) 30 x 140 mm (Round) 200 x 140 mm

Max Print Size : (Tumbler) (Flat) 30 x 60 mm (Round) 200 x 60 mm

Product size : (Flask) 29 X 7 cm (Tumbler) 10 X 7.2 cm

Packing Details : 47 x 37 x 46 cm ; 10 pcs /carton ; gw/nw: 11/12 kg / carton



Hans Larsen™  
Premium Drinkware



READY STOCK



- > Elegant Design Premium Set
- > Water Bottle & Flask Set
- > Packed In A Stylish Box

GSHL 101 - LEIDEN

Hans Larsen™ Leiden is a drinkware set consisting of a Tritan water bottle and Stainless Steel Vacuum Tumbler made from SS 304 inside and SS 201 outside.

Capacity: each 510 ml/ 17 OZ . The silicon grip ensures easy carry. Packed in a nice and presentable gift box.

Print Technique : SC, UV, ENG Preferred Print Location : Front Max Print Size : 130 x 40 mm

Product Size: 22.8 x ø7.2 cm Packing Details: 59.5 x 42.3 x 43 cm; 20 pcs /carton ; gw/nw: 11 kg / carton





READY STOCK



- >> SS Water Bottle with easy Grip & Flat Sides
- >> Bottle, Notebook & Pen Set In Gift Box

- >> Pen With German Dokumental® Ink
- >> 216 Pages Notebook With Legendary Flair

**GSSN 101 - ARGAKI**

SANTHOME Gift set consisting of a double wallet water bottle, pen and notebook. The water bottle keeps liquids cold for up to 12 hours and hot for 8 hours without any sweating on the exterior. Notebook is a retro piece of art that gels perfectly with the hexagonal body pen having German Dokumental® ink. A perfect gift that communicates modern flair.

(Notebook) Print Technique : SC, FO, UV, EMB  
 (Pen) Print Technique : SC, UV, ENG  
 (Bottle) Print Technique : UV, SC, ENG  
 Product Box Size : 28 X 25.5 X 9 cm

Preferred Print Location : Front  
 Preferred Print Location : Barrel  
 Preferred Print Location : Front

Max Print Size : 160 x 100 mm  
 Max Print Size : 25 x 6 mm  
 Max Print Size : 30 x 120 mm

Packing Details : 66.5 X 55.5 X 29 cms ; 16 pcs / carton ; gw / nw : 16.3 kg / carton



Exclusive glassware made by professional glassmakers in Italy. The base is created using the most sophisticated technology and the decoration is completely done by hand by experienced craftsmen in this field.



READY STOCK

### Caffè Deborah Cup Set - Versac Gold Black



**HLSAN 203** - CAFÉ DEBORAH

Packing Size : 27 x 19.5 x 9 cms

Packing Details : 42 x 30 x 29 cm

6 set /carton ; gw/nw: 2.92 kg / carton

Print Technique : SC

**HLSAN 202** - CAFÉ DEBORAH

Packing Size : 38 x29.5 x9.5 cms

Packing Details : 62 x 40 x 33 cm

6 set /carton ; gw/nw: 5.83 kg / carton

Preferred Print Location : Opp.Handle

**HLSAN 201** - CAFÉ DEBORAH

Packing Size : 48 x 31.5 x 12.5 cms

Packing Details : 65 x 50 x 40 cm

6 set /carton ; gw/nw: 8.75 kg / carton

Max Print Size : 20x5mm



*Exclusive glassware made by professional glassmakers in Italy. The base is created using the most sophisticated technology and the decoration is completely done by hand by experienced craftsmen in this field.*



*Made in Italy*

**READY STOCK**

**Tea Deborah Cup Set - Versac Gold Black**



**HLSAN 206 - TEA DEBORAH**

Packing Size : 27 x 19.5 x 9 cm  
Packing Details : 62 x 30 x 29 cm  
6 set/carton ; gw/nw: 4.26 kg / carton

Print Technique : SC

**HLSAN 205 - TEA DEBORAH**

Packing Size: 38 x29.5 x9.5 cm  
Packing Details : 62 x 40 x 33 cm  
6 set /carton ; gw/nw: 8.53 kg / carton

Preferred Print Location : Opp.Handle

**HLSAN 204 - TEA DEBORAH**

Packing Size: 48 x 31.5 x 12.5 cm  
Packing Details : 65 x 50 x 40 cm  
6 set /carton ; gw/nw: 12.79 kg / carton

Max Print Size: 30x10mm



Hans Larsen™  
**GRANDEUR**  
DESIGN



**DWHL 507 - ABASHA**

Hans Larsen™  
**GRANDEUR** DESIGN Abasha is the ultimate bottle to consume all your favourite shakes and supplements from. The body is made out of TRITAN™ material so it is scratch proof and durable. The insert allows for easy mixing of all powders. Capacity: 800 ml.

Print Technique : UV, SC Preferred Print Location : Front Max Print Size : (Flat) 30 x 130 mm (Round) 75 x 130 mm

Packing Details: 50pc /carton; gw/nw: 9.1/10 kg / carton

READY STOCK

Hans Larsen™  
Drinkware



SWEL

**DWHL 216 - White DWHL 217 - Red**

Hans Larsen™ Swel is a 400ml protein shaker with Three compartments, first /top for liquid, second for vitamins, and third for protein powder. Made from BPA free materials and is leakproof. Carabiner allows easy clipping onto your belt loop or backpack.

Print Technique : SC Preferred Print Location : Front Max Print Size : (Flat) 40 x 60 mm

Product Size : 21.8 x ø9.5 cm Packing Details : 53 x 53 x 33 cm; 50 pcs/carton; gw/nw: 11 kg/carton



- 183 x 61 cm Size , 0.5 cm Thick
- Cork is a renewable material
- Stay fit, Stay healthy
- Employees (HR) gift



**WNEN 166 - ARCALIS**

Cork Yoga mat - high end feel. TPE used in base material.

Print Technique : SC,HT

Preferred Print Location : Pouch

Max Print Size: 200 X 50 mm

Product Size : 183 X 61 X 0.5 cm

Packing Details : 47 X 35 X 63.5 cm ; 12 pcs / carton ; gw / nw : 10.8/11.8 kgs / carton

**READY STOCK**



**Giftology**  
YOGAMAT



**WNG1 101 - VERONA**

Giftology Designed for the yoga enthusiasts on the go, this foldable Yoga mat provides superior grip on carpet or hard surfaces and folds up to fit easily into your travel bag. It is made from 6mm environmental friendly PVC material and is water resistant and durable. Start your healthy lifestyle now!

Print Technique : SC

Preferred Print Location : Front

Max Print Size : 250 x 200 mm

Product Size : 173 X 61 X 0.6 cm (Flat) and 30 X 25 X 9 cm (Folded)

Packing Details : 52 x 33 x 57 cm; 12 pcs/carton; gw/nw: 15kg/carton



**WNE165 - XANTHI**

Cotton jumping rope with wooden handle in a cotton pouch

Print Technique : SC

Preferred Print Location : Pouch

Max Print Size : 110 x 150 mm

READY STOCK



Skipping Rope



Stretch Band



Exercise all muscles incl Cardio

Value-driven fitness gift

HR distribution to employee

**GSWN 521 - WALTROP**

Set of skipping rope & stretch band in pouch

Print Technique : SC

Preferred Print Location : Pouch

Max Print Size : 50 x 110 mm



**GSWN 522 - DASSEL**

Set of Skipping Rope & Resistance band in pouch

Print Technique : SC

Preferred Print Location : Pouch

Max Print Size : 50 x 150 mm



- > Made from Recycled PET fabric certified by Global Recycled Standards
- > 3% of sales proceeds of each product is committed to Water.org
- > High-end Sustainable
- > This bag saved 43 liters of water
- > This Bag is made by recycling 17 plastic bottles



**GO directly to office from gym -  
Go directly to gym from office**

**AN EXECUTIVE  
Duffel Bag**

**SAY NO TO GREENWASHING**

*Tell the true story of sustainability with genuine recycled rPET*

**Certified by**



**GIFTS THAT GIVE BACK**

- 💧 785 million people - 1 in 9 - lack access to safe water. We are supporting Water.org to change this.
- 💧 For each CHANGE bag sold, **3% of sales is donated** by brand owners to Water.org to save lives with safe water and sanitation.



**READY STOCK**



**DBSN 661 - PEGEIA**

SANTHOME CHANGE Duffel / Weekender / Gym Bag made from high-end durable 1680D recycled rPET (certified by GRS) and stylish leather components. Includes special shoe compartment. Each bag saves 43L of water and reuses 17 plastic bottles, while supporting Water.org to provide safe water to people in need with each purchase.

Print Technique : SC, HT

Preferred Print Location : Pocket

Max Print Size : 100 X 200 mm

Product size : 54 x 26 x 25 cm



# Giftology

Navy/Grey



- > 600D Polyester Duffle Bag
- > Lightweight & Durable

Black/Grey



LYSS

TBGL 101 - Black/Grey TBGL 102 - Navy/Grey

Giftology Lyss is a 600D polyester duffle bag which offers a lot of space for you to fill in all your items to carry for your trip. On the outside, it features 2 net pockets on the sides which gives you easy access to your belongings along with a pocket on the front of the bag. This value bag is sure to fulfil your advertising motive.

Print Technique : SC, HT Preferred Print Location : Front Pocket  
Max Print Size : 150 x 130 mm Product Size : 52 x ø25 cm  
Packing Details : 55 x 43 x 35 cm; 30pcs/carton; gw/nw: 13 kg/carton



soft & stretchy



## SPORT BAND



GMMK 150 - FREDERICKSBURG

Sports sweat band made from stretchy & soft sweat absorbing materials.

Print Technique : HT Preferred Print Location : Front  
Max Print Size : 40 x 50 mm Product Size : 0.7 x 260 cm  
Packing Details : 35 x 36.5 x 60 cm ; 1000 pcs / carton ; gw / nw : 13 kg / carton

READY STOCK

## SANTHOME

Blue



Black



SHOBAC

BPSN 915 - Blue BPSN 916 - Black

SANTHOME Shobac is a 18"laptop backpack for the modern man who wants to work hard during the day and perform sports or go the gym in his leisure time. This backpack has 2 main compartments, a side mesh pocket, an air mesh back and high quality jaquard lining. Be active, Be smart!

Print Technique : SC, ENG Preferred Print Location : Front Flap  
Max Print Size : 140 x 50 mm Product Size : 45 x 30 x 14.5 cm  
Packing Details : 49x 38 x 58 cm ; 10 pcs / carton ; gw / nw ; 13 kg / carton

## Sweatproof Waterproof Waist Pouch

Spandex Material



Sensitive Touch Screen

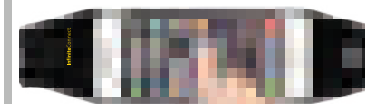

Black

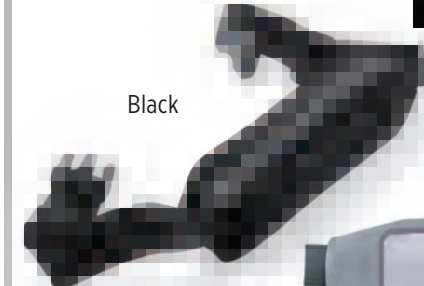

Grey



WNWB 201 - Black WNWB 202 - Grey

WBSIN Slim and lightweight waist pouch for your smartphone and for other useful things needed during sports activities. It has an adjustable belt, reflective tape around the zipper, an output for headphones and touch frontal part for devices. It is suitable for smartphones up to 5".

Print Technique : SC Preferred Print Location : Front Left  
Max Print Size : 20 x 35 mm Product Size : 27.5 x 9.5 x 1.5 cm  
Packing Details : 108.5 X 26 X 31.5 cm ; 100 pcs/carton; gw/nw: 11kg/carton





XDDDESIGN®  
**BOBBY URBAN**  
Anti-theft Backpack  
with Anti-cut Material



Scan Below QR  
code to watch  
product video



READY STOCK



ANTI CUT MATERIAL MADE FROM ULTRA-HIGH MOLECULAR WEIGHT POLYETHYLENE FABRIC + FIBRE GLASS POLYESTER



STEEL REINFORCED NUMBER LOCK MAKES IT IMPOSSIBLE TO OPEN OR CUT THROUGH THE BAG WHEN LOCKED TO A FIXED OBJECT

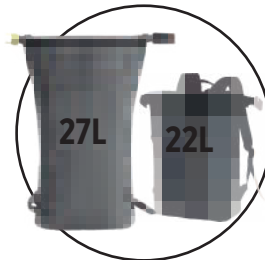

27L CAPACITY WHEN FULLY PACKED. SMALLEST CAPACITY WHEN FOLDED IS AROUND 22L

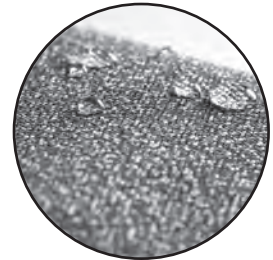

BOBBY URBAN IS WATER REPELLENT MAKING IT A RUGGED COMPANION INSIDE AND OUTSIDE THE CITY



STORE YOUR CARD IN A POCKET THAT PREVENTS RFID THEFT. IT IS IMPOSSIBLE FOR ANYONE TO ACCESS THE DATA ON YOUR CARD VIA RFID



NEED EVEN MORE CAPACITY? SIMPLY FIX THE NET AT THE FRONT OF THE BACKPACK TO SECURE YOUR FOOTBALL OR BASKETBALL



BACK PANEL WITH ELASTIC STRAP DESIGNED TO SLIP OVER TROLLEY HANDLES



HIDDEN POCKETS ON THE SHOULDER STRAP AND BACK OF THE BAG

**BGXD 605 - BOBBY URBAN**

XDDDESIGN® The Bobby Urban anti-theft cut-proof backpack is your safest travel companion yet. It's made of high quality anti-cut fabric and the main compartment can be completely locked with the steel reinforced combination lock. This function can also be used to lock the bag around a fixed object. There are hidden pockets on the backside and in the shoulder strap for cards, with RFID protection. The bag comes with a side water bottle pocket and detachable elastic net for your sports equipment. While on the inside there are padded compartments for a 15.6" laptop, tablet up to 12.9" and mesh pockets for your other belongings. Registered design®

Print Technique : SC Preferred Print Location : Front Max Print Size : 80 x 40 mm  
Product Size: 32 x 47-64 x 15 cm Packing Details : 52 X 45 X 48 cms ; 6 pcs / carton ; gw / nw : 9.83 kg / carton



# FITNESS TRACKER WATCH



Blue

**VALUE**



Aqua

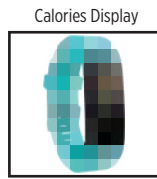

Calories Display

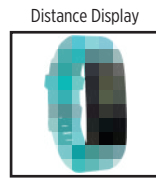

Distance Display

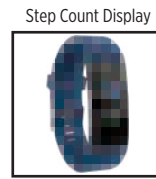

Step Count Display

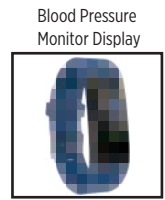

Blood Pressure Monitor Display

### Hardware Features :

- Band : Material : Silicon  
Length: 255mm
- Screen : Size: 0.96inch  
Type: TFT  
Resolution: 80\*160
- Battery : Battery Capacity: 90mAh  
Standby Time: 10days  
Normal Use Time: 7days
- Weight : 82g
- Operating Mode : Single Touch
- Compatible OS : Android 4.3, IOS 8.0 or above

### Other Functions :

- Do not disturb mode
- Information reminder
- Clock display
- Instagram Notification
- Facebook Notification
- Call Notification
- Twitter Notification



Scan Below QR code to watch product video



PUCON  
WNAT 814 - Blue WNAT 816 - Aqua

Giftology Puccon is a smart activity tracker that keeps track of your daily activities & helps you stay fit & healthy. It counts your steps, calories and monitors your sleep. Functions also include Incoming call reminder, selfie remote and music play control. The band is lightweight and very comfortable to wear day and night. It records & presents your data effectively to help you achieve your fitness goals. Packed in a gift box .

Print Technique : UV, ENG Preferred Print Location : Strap Max Print Size : 25 x 8 mm  
Product Size : 25 x 2.3 x 1.3 cm Packing Details : 46 x 28.3 x 24 cm; 99 pcs/carton; gw/nw: 5.3 kg/carton

READY STOCK



**VALUE**



Red



Black



Blue

Call alerts

Wakeup clock   
Set the time & it will wake you up

Steps   
Records the number of steps taken everyday

Distance   
Calculates the distance you walk everyday

Sleep monitor   
Monitor your deep/light sleep

Calories   
Displays Calories Burned. Keep a track of your fitness!

SMS/SMS alert

- > Color Screen With Single Touch Control
- > Blood Pressure & Oxygen Monitor
- > IPX7 Waterproof
- > Value Deal !!



WANAKA  
WNAT 301 - Black WNAT 302 - Navy Blue WNAT 303 - Red

Giftology Wanaka is a activity tracker watch with 1.3" single point touch screen. Features include: Step count, calories, distance, alarm clock, sleep monitor, anti lost, remote photo, blood pressure monitor, oxygen monitor, notifications: SMS, Facebook, Skype, WhatsApp, Twitter etc. Compatible with Android 4.3 and IOS 8.0 and above. IPX7 waterproof. Battery time up to 80 hours on one charge depending on usage.

Print Technique : ENG, UV Preferred Print Location : Strap Max Print Size : 40x10 mm  
Product Size : 25 x 3.8 x 1.1 cm Packing Details : 45 X 27 X 33 cm; 100 pcs/carton; gw/nw: 5 kg/carton



**SGMK 101 - ISKAR**

Sunglasses with UV400 protection of classic design. Matte finish frame with black lenses.

Print Technique : SC

Preferred Print Location : Right & Left Frame

Max Print Size : 40 X 6 mm

Packing Details : 40 X 22 X 77 cm ; 300 pcs / carton ; gw / nw : 8 kg / carton

**eco-neutral**



Blue



Green



WHEAT STRAW

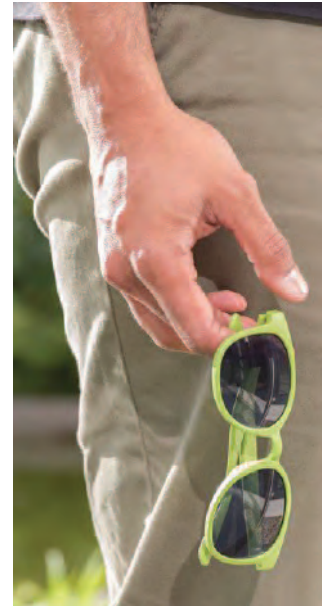

**PRILEP**

SGEN 101 - Blue SGEN 102 - Green

**eco-neutral** Sunglasses with frame made out of wheat straw fibre. Packed in kraft paper box. With UV 400 glasses.

Print Technique : SC

Preferred Print Location : Side

Max Print Size : 50 x 5mm Product Box Size : 3 X 5.5 X 14.5 cm

Packing Details : 65 X 29.5 X 41 cm ; 200 pcs / carton ; gw / nw : 10 kg / carton



Black



Red

**MARTEN**

SGMK 102 - Black SGMK 103 - Red

Sunglasses with UV400 protection of classic design. With glossy finish frame in fun colors and black lenses.

Print Technique : SC

Preferred Print Location : Right & Left Frame

Max Print Size : 40 X 6 mm

Packing Details : 37 X 40 X 47 cm ; 300 pcs / carton ; gw / nw : 9 kg / carton



**GPMK 101 - MADAN**

Polyester Eyewear cleaning cloth cover in soft polyester with self-closing laces.

Print Technique : SC

Preferred Print Location : Center

Max Print Size: 100 X 50 mm

Product Size : 9 X 18 cm

Packing Details : 26 X 23 X 55 cm ; 1000 pcs / carton ; gw / nw : 8 kg / carton

READY STOCK



## SPORT & FITNESS



Stereo headset

**VALUE**

### WIRELESS SPORTS EARBUDS

Comfort, Ergonomic Design



Volume Buttons on earpod for easy control



ITBH 781 - BEATEX

**@memori** Wireless sport earbuds play your favorite music with built in 100 mAh battery that allows you to use the gadget up to 5 hours. Bluetooth version 4.0. The App is compatible with IOS 9.0 and Android 4.4 and higher.

Print Technique : UV,SC

Preferred Print Location : Right and Left Sides

Max Print Size : 25 X 10 mm

Product Size : 3.3 X 1.6 X 5.3 cm

Packing Details : 38 x 23 x 62.3 cm ; 50 pcs / carton ; gw/nw: 11 kgs/ carton

READY STOCK



GA 4025 - AMBULP

Real Cow Leather Pouch Holds 2 balls, 3 tees and 1 pitch repairer

Print Technique : EMB, ENG, SC

Preferred Print Location : Flap

Max Print Size : 35 x 55mm

Product Size : 5.2 x 9 x 5cm



### Genuine Leather Golf Pouch

### FRISBEE

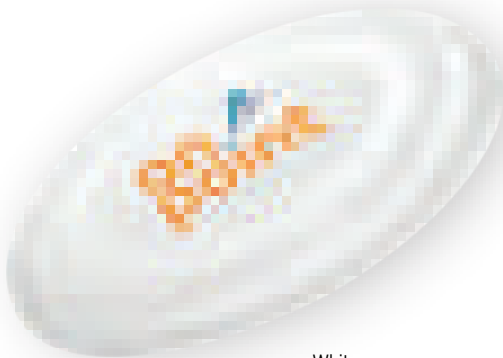

White

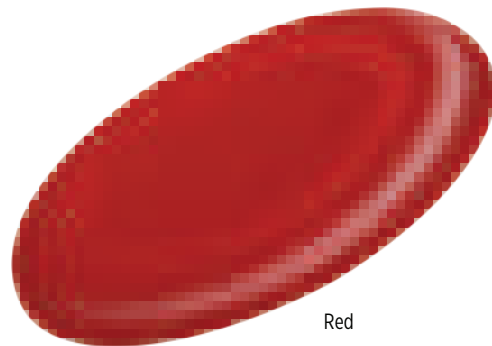

Red

BURGAS

GMMK 104 - White

GMMK 106 - Red

Frisbee

Print Technique : SC

Preferred Print Location : Center

Max Print Size: ø100 mm

Product Size : 1.8 X ø23 cm

Packing Details : 33 X 50 X 74 cm ; 300 pcs / carton ; gw / nw : 16.5 kg / carton

# THE GOLF LINE

## Includes



- Complete line of golf accessories golfers use on and around the green
- All products are patented
- Rated as Best Divot Repair tool Golf Digest 2018
- Multiple awards in innovation
- Used by Europe Ryder Cup Team



**SANTHOMÉ**

*Golf • Legacy*



- High Quality Range for Clubs' Shops, Members' Memorabilia, Event Sponsorship Gifts
- Includes Gift Sets, Bag Tags, Divot Tools, Towels, Tees, Gloves, Balls, Groove Tools, Polos, Caps, Shoe Bags, Pouches
- Quality Branding with Consistency

READY STOCK

*Truly the best ball mark fixer I've ever used*

Chip Beck





### Pitchfix Retail Displays



GAPF 582

PAR 2.0 Display  
Pitchfix Display for Tools and Ballmarker



GAPF 583

BIRDIE 2.0 Tools & Hat Clips  
Pitchfix Display for Tools,  
Ball marker and Hat clips.



GAPF 584

BIRDIE 2.0 Display  
with added 16 tools module

READY STOCK



## Pitchfix Original 2.0

WITH PITCHFIX<sup>®</sup> LOGO

- Switchblade function, 4 colours
- High-quality ABS handles
- Lightweight, aluminium sheets
- Removable logo ball marker



**Watch Product Video**



Tin Box Available on request  
GAPF 581



GAPF 561WL  
Black

GAPF 562WL  
Blue

GAPF 563WL  
Red

GAPF 564WL  
Green



GAPF 566WL  
Blue



GAPF 568WL  
Green



GAPF 565WL  
Black



GAPF 567WL  
Red

**READY STOCK**

## Pitchfix XL 3.0

WITH PITCHFIX<sup>®</sup> LOGO

- Switchblade function, 4 colours
- High-quality ABS handles
- Lightweight, aluminium sheets
- Removable logo ball marker



**Watch Product Video**



GAPF 572WL  
Black



GAPF 573WL  
Blue



GAPF 574WL  
Pink

### Pitchfix Hybrid 2.0 WITH PITCHFIX® LOGO

- > Switchblade function, 3 colours
- > Soft Touch handles
- > Lightweight, aluminium sheets
- > Removable logo ball marker
- > Integrated pencil sharpener



[Watch Product Video](#)



READY STOCK



Tin Box Available on request  
GAPF 581

### Pitchfix Fusion 2.5 Pin WITH PITCHFIX® LOGO

- > ABS rubberized handles
- > Available in 3 colours
- > Colored aluminium trims
- > Pencil sharpener
- > Removable 1" ball marker



[Watch Product Video](#)



GAPF 569WL  
Black



GAPF 570WL  
Blue



GAPF 571WL  
Pink







**GAPF579WL - TROMSO**  
Black



**GAPF587WL - TROMSO**  
Red



**GAPF 586 WL - TROMSO**  
Blue

## Pitchfix Round Tin Tool & 2 Extra Ball Markers

WITH PITCH FIX LOGO

Our metal round turns Pitchfix into a high quality gift item. Set contains

- 1 x Pitchfix Original 2.0
- 2 x Ball marker
- 1 x Premium Gift Tin



**GAPF 580 WL**  
Black



**GAPF 589 WL**  
Pink



**GAPF 588 WL**  
Blue

## Pitchfix Round Tin Tool, Hat Clip & 2 Extra Ball Markers

WITH PITCH FIX LOGO

Our metal round tin turns Pitchfix into a high quality gift item. Available colours Black, Blue, Pink.

- Contents:**
- 1 x Branded Pitch fix Original 2.0 (choice of divot tool)
  - 1 x Branded Ball marker (GAPF 585)
  - 1 x Branded Hat Clip (choice of hatclip)
  - 1 x Branded Premium Gift Tin (GAPF 580)

READY STOCK



**GAPF 576 WL**  
Black



**GAPF 577WL**  
Blue



**GAPF 578 WL**  
Pink

## Pitchfix Hat Clip 25mm

- Available in 3 colours
- Stainless Steel
- Light weight
- Removable logo ball marker



**Watch Product Video**



# CORPORATE

Golf Gifts from Pitchfix



READY STOCK



www.pitchfixUSA.com

4

## GREAT PERFORMANCE.

Performance matters when in the middle of a golf course, no one carries 'spares'. Our tools are proven to deliver excellent reliability and performance to be a positive reflection of our brand and also yours!

*All our tools are designed to include a customized ball marker to feature your own name, logo or crest*



**GREAT BRANDING.**

All of our products can be branded, in full colour, with your club, society or corporate logo. Our hard resin doming production ensures your design remains crystal clear for years.



*WE CAN EVEN OFFER TOOLS  
PERSONALISED WITH THE RECIPIENTS  
NAME ON REQUEST -*

*CONTACT OUR TEAM FOR DETAILS!*

**JUST GREAT!**



**GREAT COLOURS**

Our complete product range is available in wide variety of colours to ensure your logo will stand out from the crowd.

**GREAT PACKAGING**

The perceived value of a gift is always increased with professional packaging. Whether supplied as a pre-event invitation, a 1st tee gift, table reward, locker room award, membership or sales incentive, our high quality steel alloy presentation packaging elevates your branded items to a memorable and valuable gift.

**GREAT CHOICE**

We have a flexible range of tools and packaging options to suit every budget or event. Our team will work with you to make the right selections for your needs.

**GREAT VALUE**

Investing in high quality promotional gifts is a proven method to ensure your marketing budget reaches its maximum potential. By placing your logo on the best golf accessories in the business, any golfer will know and associate your brand with the highest quality.

The value of a constant reminder of your brand in your recipients hand, in the form of a useful and desirable product is a marketing asset that can continue to deliver exposure and goodwill time and time again.



READY STOCK



GAPF 561  
Black



GAPF 562  
Blue



GAPF 563  
Red



GAPF 564  
Green

### Pitchfix Original 2.0

YOUR LOGO EPOXY DOMING 1 POSITION PER ITEM

- Switchblade function
- 4 colours: Blue, Black, Green, Red
- High-quality ABS handles
- Lightweight, aluminium sheets
- Removable logo ball marker



Tin Box Available on request  
GAPF 581

READY STOCK



GAPF 572  
Black



GAPF 573  
Blue



GAPF 574  
Pink

### Pitchfix Hybrid 2.0

YOUR LOGO EPOXY DOMING 1 POSITION PER ITEM

- ABS rubberized handles
- 3 colours: Blue, Black, Pink
- Colored aluminium trims
- Pencil sharpener
- Removable 1" ball marker



Tin Box Available on request  
GAPF 581





GAPF 569  
Black

GAPF 570  
Blue

GAPF 571  
Pink



## PitchfixFusion 2.5 Pin

YOUR LOGO EPOXY DOMING 1 POSITION PER ITEM

- ABS rubberized handles
- 3 colours: Blue, Black, Pink
- Colored aluminium trims
- Pencil sharpener
- Removable 1" ball marker



Tin Box Available on request  
GAPF 581



Tin Box Available on request  
GAPF 581

## Pitchfix XL 3.0

YOUR LOGO EPOXY DOMING 2 POSITIONS PER ITEM

- Switchblade function
- 4 colours: Blue, Black, Green, Red
- High-quality ABS handles
- Lightweight, aluminium sheets
- Removable logo ball marker



GAPF 565  
Black

GAPF 566  
Blue

GAPF 567  
Red

GAPF 568  
Green

READY STOCK



### Pitchfix Hat Clip 25mm

YOUR LOGO EPOXY DOMING 1 POSITION PER ITEM

- Available in Blue, Black & Pink
- Stainless Steel
- Light weight
- Removable logo ball marker



READY STOCK

### Pitchfix Round Tin Tool & 2 Extra Ball Markers

YOUR LOGO EPOXY DOMING 1 POSITION PER ITEM

Our metal round turns Pitchfix into a high quality gift item. Set contains

- 1 x Pitchfix Original 2.0
- 2 x Ball marker
- 1 x Premium Gift Tin



### Pitchfix Round Tin Tool, Hat Clip & 2 Extra Ball Markers

YOUR LOGO EPOXY DOMING 1 POSITION PER ITEM

Our metal round tin turns Pitchfix into a high quality gift item. Available colours Black & Blue.

Contents:

- 1 x Branded Pitch fix Original 2.0 (choice of divot tool)
- 1 x Branded Ball marker (GAPF 585)
- 1 x Branded Hat Clip (choice of hatclip)
- 1 x Branded Premium Gift Tin (GAPF 580)**





# SANTHOME GOLF LEGACY & OTHER GOLF ACCESSORIES



READY STOCK



**GADT 235 - BRUGG** - Divot tool with a ball marker in a tin gift box  
Print Technique : EPOXY  
Print Location : Top of Box Max Print Size : 24 x 55 mm  
Print Location : Ball Marker Max Print Size : ø20 mm

**GALT 236 - KARAK** - Metal luggage tag with leather strap in a tin gift box  
Print Technique : EPOXY  
Print Location : Front of Tag Max Print Size : ø55 mm  
Print Location : Top of Box Max Print Size : 24 x 55 mm



## SANTHOME GOLF GIFT SETS



> Ideal for Golf events, memberships & Loyalty, Souvenirs & gifting.

### GSGA 233 - BIASCA

Elegant metal gift box with high quality Divot Tool (with Ball marker) & Bag Tag.

Print Technique: EPOXY Preferred Print Location : Top of Box, On Tag, On Ball Marker

READY STOCK



> Ideal for Golf events, memberships & Loyalty, Souvenirs & gifting.

### GSGA 234 - ASCONA

Elegant metal gift box with high quality Divot Tool (with Ball marker) & 2 Golf Balls.

Print Technique : EPOXY for Top of Box and on Ball Marker  
: PAD PRINTING for balls





**GATE 237** - KRANJI - Set of 30 wooden 7cm golf tees in a tin gift box  
Print Technique : EPOXY Preferred Print Location : On Box Max Print Size : 24 x 55 mm



READY STOCK

**ODDER**  
**GAGB 975** - GOLF BALLS  
2 layer Golf balls. Set of 3 Golf balls in customised paper packaging



**RONNE**  
**GAMT 976** - GROOVE TOOL  
Plastic groove cleaner with an extendable brush, spike, wire brush and with carabiner.



# GOLF TOWEL/ SHOE BAG

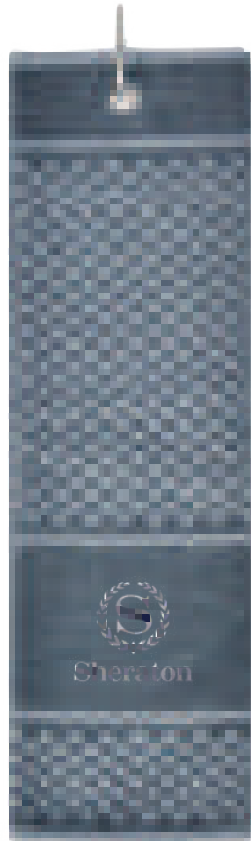

Grey

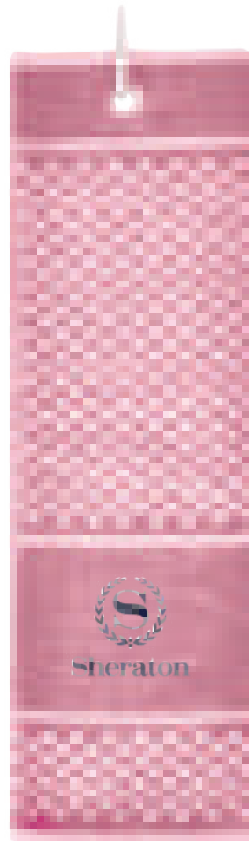

Pink



LUXURY POUCH  
PACKAGING ON REQUEST

MARABA

GATW 978 - Grey    GATW 992 - Pink

Print Technique : EMBROIDERY    Preferred Print Location : Front

Max Print Size : 90 x 70 mm

READY STOCK



PRAVETS

GASN 175 - GOLF SHOE BAG

A compact golf shoe bag with 2 sides pocket for golf accessories.

Print Technique : SC    Preferred Print Location : Front    Max Print Size : 100 x 250 mm

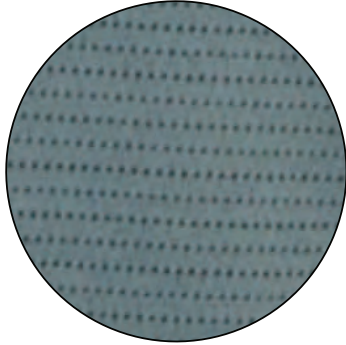

Special textured 2-tone knit fabric



- Swing+ Tech swing support mechanism
- Enhanced stretch for better range of motion
- UV protection against harmful UV sunlight
- Moisture wicking DryNCool® fabric
- Lightweight fabric

READY STOCK

  
**سانديز اند بت**  
من  
**سانتوم**  
غولف • ليجاسي

حماية من الأشعة فوق البنفسجية  
أبقى منتعشاً

  
*Sandies & Putt*  
by  
**SANTHOMÉ**  
Golf • Legacy

UV Protected  
Stay Fresh

\* تحتوي اشعة الشمس على الاشعة فوق البنفسجية الضارة ، والتي تسبب في حروق الشمس وتضر بالبشرة. مع هذا القميص الخاص من بولو يتم استخدام تكنولوجيا تعمل على منع حروق الشمس، الاضرار المزمنة التي تحدث للبشرة حتى تتمكن من الاستمتاع بالشمس في امان.

\* وباستخدام تقنية (نظام معالجة الرطوبة) ، يقوم هذا النسيج بطرد الرطوبة بعيدا عن البشرة الى سطح النسيج حيث يتبخر سريعا مما يحافظ على جفاف و راحة جسمك.

\* باتيكم هذا النسيج المصنع بتقنية نظام معالجة الرطوبة في تصاميم مميزة و يعمل بطريقة ممتازة على التهوئة بالنسيج مما يجعله اكثر راحة.

  
**معالجة الرطوبة**  
نظام  
MMS

**سانتوم** و **دراي اند كول** هي علامات تجارية مسجلة لـ **سانتوم** القابضة المحدودة (جزر فيرجين البريطانية) سوف يتم التعامل بطريقة قانونية مع أي انتهاك أو محاولة للتقليد

\* Sun rays contain harmful UV rays which cause sunburn and damage to skin. This special polo uses a technology that prevents sunburn, long term skin damage and you can enjoy sun safely.

\* Using MMS (Moisture Management System) technology, this fabric pulls out the moisture away from the skin to the surface of the fabric for quick evaporation, which keeps your body dry and comfortable. This PERFORMANCE fabric with MMS in the special Knit Design works as excellent Ventilation for free breathing of fabrics, making it more comfortable.

  
**MOISTURE MANAGEMENT**  
SYSTEM  
MMS

\*Santhome & Dryncool are registered trademarks of Santhome Holding Limited (BVI). Any infringement and duplication attempt will be dealt with legally.

Item : SNP

Content : 100% polyester, Special Knit

Measurement : Gulf Sizes Available : S, M, L, XL, XXL, 3XL

Print Technique :

1 Screen Printing 2 Heat Transfer 3 Embroidery

Preferred Print Location : Left Chest Area / Sleeve

Max Print Size: 80 x 50 mm



LEATHER GLOVE



GAGV 987 - TIDORE - Golf Gloves, Left - Medium/Large Size    GAGV 988 - TIDORE - Golf Gloves, Left - Large Size  
GAGV 989 - TIDORE - Golf Gloves, Right - Medium/Large Size    GAGV 990 - TIDORE - Golf Gloves, Right - Large Size

READY STOCK

PU GLOVE



GAGV 981 - OSASCO - Golf Gloves, Left - Medium Size    GAGV 993 - OSASCO - Golf Gloves, Left - Large Size  
GAGV 994 - OSASCO - Golf Gloves, Right - Medium Size    GAGV 995 - OSASCO - Golf Gloves, Right - Large Size



**LUXURY POUCH -**

Create your own bundle of Golf Gifts & package them in this Luxury Pouch

GAPB 984 - ROHAN

Print Technique : SC Preferred Print Location : Front Max Print Size : 19 x 25 mm

**SANTHOME**

*SANTHOME Deluxe pique mesh spandex fitted cap*

READY STOCK



- > One Size Fits All
- > Excellent Shape Retention Even After Multiple Uses
- > Contrast Color Sandwich On Front
- > Fabric With Pores For Air Ventilation

SC 105

Print Technique : HT, Embroidery Preferred Print Location : Front / Back  
 Packing Details : 62x 36 x 56 cms ; 150 pcs /carton ; gw/nw: 16.5 kg / carton

Max Print Size: 45 x 35 mm



## CUSTOMISED APPAREL

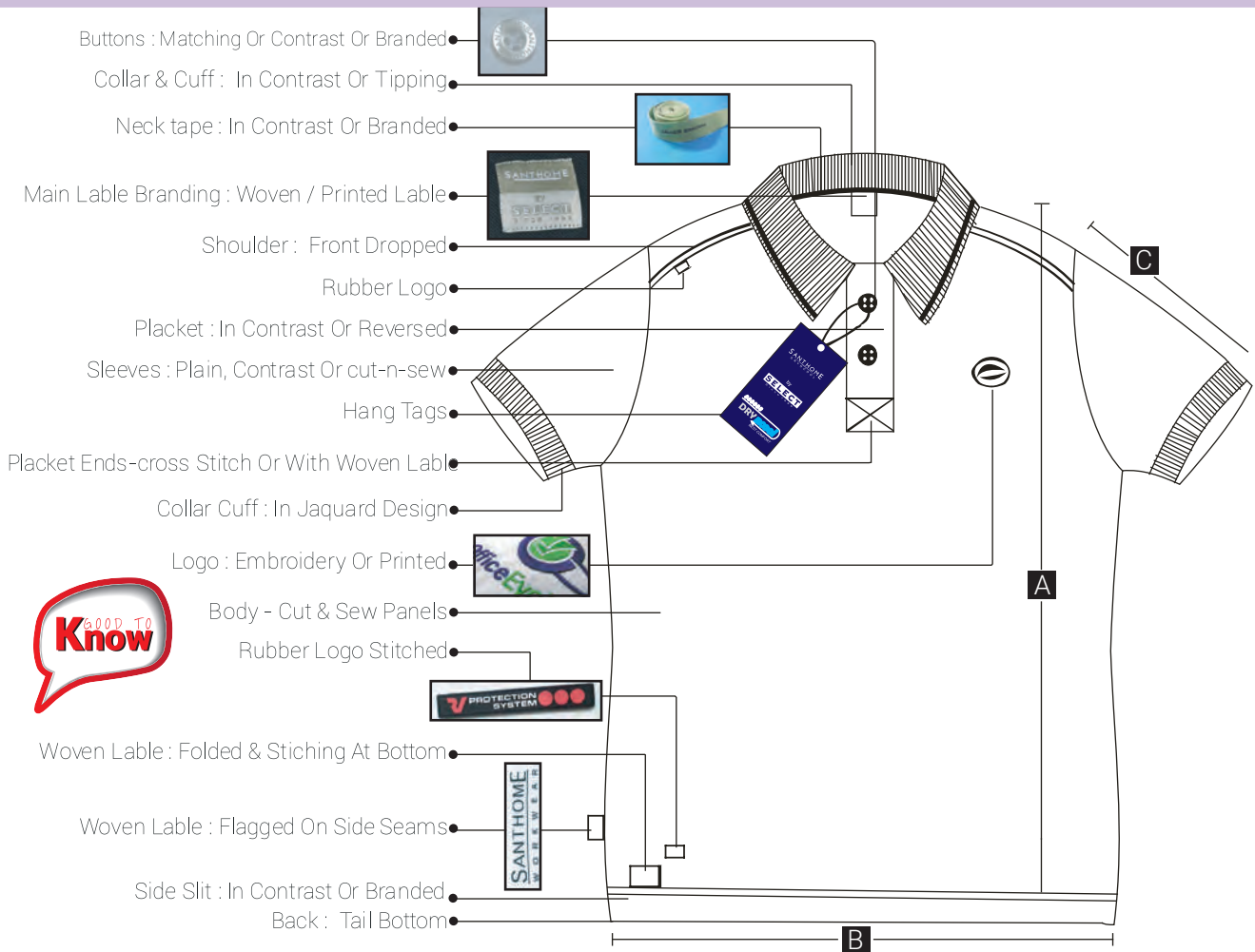

### Typical measurements:-

	Gulf/Asian Sizes			Europe Sizes		
	M	L	XL	M	L	XL
A	28	29	30	29	30	31
B	21	22	23	22	23	24
C	8	8.5	9	8.5	9	9.5

These measurements are for guidelines only. The actual measurements may vary slightly between garments as knit garments have internationally accepted higher tolerance values

### GSM or GMS ?

Most manufacturers confuse clients with this. GSM: Grammes per sq. meter is the wt. of the fabric in a square of 1 meter x 1 meter. it remains the same in all sizes. Hence the correct way to describe GMS: is the wt. in grammes per piece of the Tee/Polo And will always vary with each size.

Thus, completely misleading. We ALWAYS specify the GSM. So you are rest assured of what we offer.

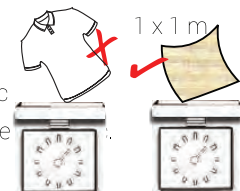

### Heavier the better ?

Not necessarily. The quality of yarn will decide the quality and Price.

Super combed, combed, semi combed and carded: this is the quality of YARN in descending order.

We specify the yarn. So you are rest assured of what we offer.

### What more we can offer:

You Are Welcome To Send Your Design Ideas And Originals. We Will Reproduce It For You..!



**BELAND**



**VECCHIA**



**INBICTA**

Various Trendy styles can be created with decoration by print and embroidery. Your special design can be created as per demand.

Fabric suggestions : 100 % Cotton, Polymesh, Dryncool, ADF etc.

Pantone matching items can be produced against MOQ requirements.

The brands & images used are for representation purpose only & belong to their respective brand owners.

**CUSTOM MADE**

## CUSTOMIZED WINTER JACKETS



Brocky Jacket  
in Tetron



100% heavy polyester soft micro jacket with multiple zipper pockets and snap button opening. Long jackets. Lined with heavy fleece. Subtle contrasts make it trendy and functional.



100% cotton twill reporter jacket with various pockets for multiple use.

The brands & images used are for representation purpose only & belong to their respective brand owners.



## CUSTOMIZED ACTIVE WEAR



Polymesh Track set for ladies with lining of cotton jersey



CUSTOM MADE



WROCLAW



BUKINI

Bukini using stretch material

The brands & images used are for representation purpose only & belong to their respective brand owners.



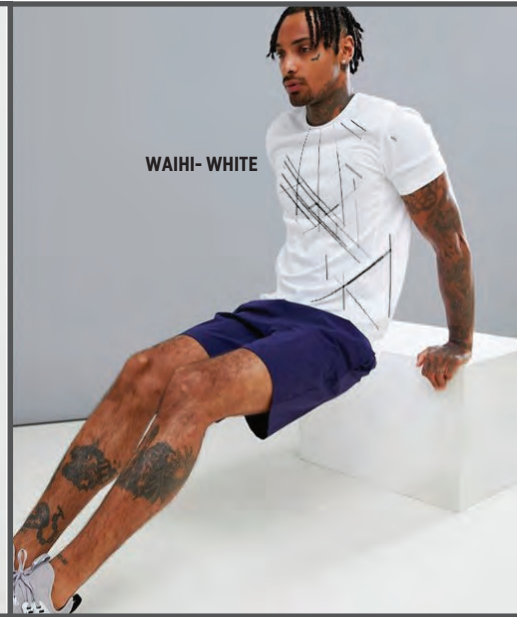

CUSTOM MADE

Amazing trendy sportswear of high quality can be produced using ADF, Polymesh or special materials. Branding by special quality printing is also possible against MOQ requirements.

The brands & images used are for representation purpose only & belong to their respective brand owners.



## CUSTOMIZED COVERALLS

SANTHOME  
WORKWEAR



CUSTOM MADE



SANTHOME WORKWEAR are customized for workshops and showrooms as smart outfits meeting exacting standards of quality and performance. # Kameer has provision for knee pads for extra protection at work. 100% cotton or polycot fabric will meet client requirements of comfort and utility.

The brands & images used are for representation purpose only & belong to their respective brand owners.



Formal shirts and trousers in various colours, fabric qualities. Designs can be made customized to the need of the industry. Shirts come in plains and oxfords. Trousers come in PV, PC and cotton.



Men's Solid shirt



Oxford Ladies Shirt

Formal modern fit PV pleated trousers

CUSTOM MADE



HILTON CARGO PANT

BEWEAR Shirt in 100% cotton twill has excellent resilience to everyday wash and wear. Two patch pockets with button through flaps on front and a pen slot on sleeves. Ideal for driver sandas Security uniforms. Co-ordinated HILTON cargo Pants in 100% cotton Chinos are a smart uniform for staff.



KORAM

KORAM Messenger Uniforms Set: Polycot Multipanel shirt with black Polycot trousers. Smart uniforms that will also delivery our identity!

The brands & images used are for representation purpose only & belong to their respective brand owners.

# Recycled Polo

## Our Transparent Process

**COLLECTION**  
of plastic bottles,  
removing labels & foreign materials,  
making it process - ready



**COLLECTION**  
of cotton fabric waste,  
also called post-industrial  
cotton waste, making it  
process-ready



**SHREDDING**  
Used water bottles into  
fiber, certified by the  
Global Recycled Standard



**SHREDDING**  
post-industrial cotton waste  
into fiber, certified by the  
Global Recycled Standard



**YARNS**  
produced by spinning the fiber



**YARNS**  
produced by spinning the  
fiber



**FABRIC**  
produced by using cotton &  
plastic yarns together



**APPAREL**  
produced from the Recycled fabric,  
certified by the Global Recycled Standard



**VERIFICATION DOCUMENT**  
available, as the above process is  
entirely transparent

**GREENWASHING DISCOURAGED**  
by using above verifiable process,  
ensuring positive impact on  
environment



**PLEGGED DONATION**  
of 3% of sales proceeds to  
water.org ensures safe water  
& sanitation to the needy

**Plastic Bottles**  
recycled, positive impact



**RECYCLED COTTON**  
ensures fresh cotton is  
not used, positive impact



**WATER SAVINGS**  
as fresh cotton fabric  
production consumes  
huge quantities of water



SANTHOME

**PRO EARTH**  
SHIRT IS MADE FROM  
17 PLASTIC BOTTLES



THIS SHIRT HAS SAVED  
1,260L OF WATER

SANTHOME

**PRO EARTH**  
FULLY RECYCLED POLO

MADE FROM  
60% RECYCLED COTTON  
AND 40% RECYCLED PET





The PRO EARTH Polos from Santhome use

LESS WATER • LESS CHEMICALS • LESS EMISSION • LESS ENERGY • LESS WASTE • REDUCE CARBON FOOTPRINT



Navy Blue



White



Black

-1,260L

17

READY STOCK

> 3% of sales proceeds of this Polo committed to Water.org by the brand owners

Item : PRO Earth Polo

Content : 40% Recycled PET, 60 % Recycled Cotton

Measurement : Gulf Sizes

Sizes Available : S- XXXL

Care Instructions:

Print Technique :

- ① Screen Printing
- ② Heat Transfer
- ③ Embroidery

Preferred Print Location : Max Print Size:  
Left Chest Area / Sleeve 80 x 50 mm

PRO EARTH POLO

**CHANGE.**  
SERIOUS SUSTAINABILITY

THIS SHIRT IS MADE FROM 17 PLASTIC BOTTLES

THIS SHIRT HAS SAVED 1,260L OF WATER

SANTHOME

**PRO EARTH**  
FULLY RECYCLED POLO

MADE FROM 60% RECYCLED COTTON AND 40% RECYCLED PET

**THE GIFT OF WATER**

For each product sold, the brand owner will donate 3% of sales to support Water.org to change lives with safe water and sanitation

a US-based 501(c)(3) global non-profit organization

**785M**

785 million people - 1 in 9 - lack access to safe water

We are supporting Water.org to change this

سکیور  
SECURE

THE  
ANTI-MICROBIAL  
DRYNCOOL  
EXECUTIVE  
POLO SHIRT

READY STOCK



Black



Navy



Red



White



Grey

Item: SECURE | Content: Dryncool fabric  
Measurement: Gulf | Sizes Available: S, M, L, XL, XXL, 3XL

SILAIDE 100 Anti Microbial Polo  
Premium executive wear  
No-fuss performance.  
Creaseless.  
Dryncool Moisture Management Technology

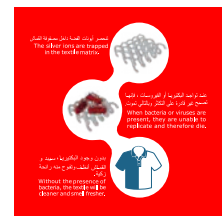

### Print Technique :

- 1 Screen Printing
- 2 Heat Transfer
- 3 Embroidery

Preferred Print Location : Max Print Size:

Left Chest Area / Sleeve

80 x 50 mm

### Care Instructions:



### Packing:



53 x 33 x 45cm; 50 pcs/carton ; gw/nw: 15/16kg / carton

\* Packing details may have ± 10% variation based on size breakup

\* Printing Limitations prevent exact fabric and color representation.  
The shades in the lots may differ due to lot-to-lot variations.  
The difference is no more than internationally accepted norms of the garments trade.

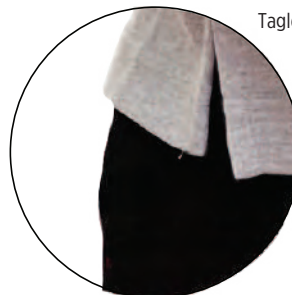

Side slits with bartack

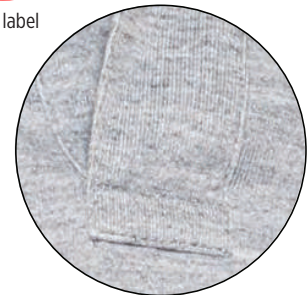

Double placket

READY STOCK

الدرع  
SHIELD

HEIQ SWISS  
TECHNOLOGY

VIROBLOCK  
ANTIVIRAL  
PROTECTION

READY STOCK

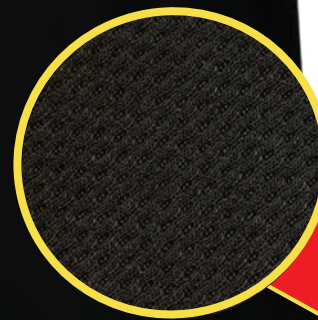

COMFORT KNIT



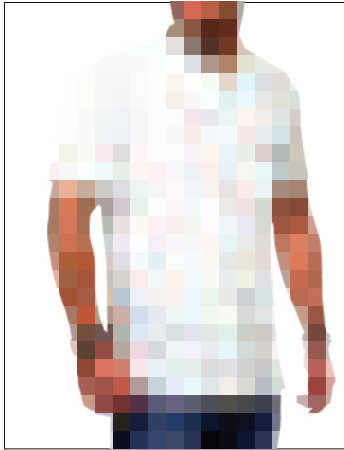

White



Black



Navy

Item: Shield | Content : 100% Polyester  
Measurement : Gulf | Sizes Available : S, M, L, XL, XXL, 3XL

VIROBLOCK ANTI VIRAL PROTECTION

- Executive wear.
- Premium quality.
- No-fuss performance.
- Creaseless.

DryNCool Moisture Management Technology

Print Technique :

- 1 Screen Printing
- 2 Heat Transfer
- 3 Embroidery

Preferred Print Location : Max Print Size:

Left Chest Area / Sleeve 80 x 50 mm

Care Instructions:



Packing:

51 x 36 x 41cm ; 50 pcs /carton ; gw/nw: 14/12kg / carton  
\* Packing details may have ± 10% variation based on size breakup

Constructed from intelligently designed antimicrobial fabric, this wicking polo shirt SHIELDS against viruses and bacteria that use fabrics as hosting surfaces.

HEIQ Viroblock product is EU BPR and US FIFRA compliant.

\*Santhome & DryNCool are registered trademarks of Santhome Holdings Limited (BVI). Any infringement or duplication attempt will be dealt with legally.

\*This article does not claim to prevent infectious diseases or imply any public health claims

مصنوع من قماش مضاد للميكروبات مصمم يتكاد، تم تصميم خيوط قميص البولو المضاد للفيروسات والبكتيريا التي تستخدم الأقمشة كسطح للتواجد.

منتج هيك فيروبلوك متوافق مع قانون منتجات المبيدات الحيوية للاتحاد الأوروبي ، ومع القانون الاتحادي للمبيدات الحشرية ، ومبيدات الطفيليات، ومبيدات الفواض في الولايات المتحدة.

\*استثمر اند بّي ان كولد علامة تجارة مسجلة لشركة سنثوم القفصة المحدودة (بحرين هولدينغز) . سيتم التعامل مع أي محاولة للتقليد أو النسخ بشكل قانوني.

\*هذا المادة لا تضمن الوقاية من الأمراض المعدية أو تنفي أي برامج تنصح بالصحة العامة.

قميص بولو مضاد للفيروسات والبكتيريا  
The silver ions are trapped in the textile matrix.

عند تواجد البكتيريا أو الفيروسات ، فإنها تمسح بمرققة على النسيج وتبقى تحتها. When bacteria or viruses are present, they are unable to replicate and therefore die.

لا توجد بكتيريا ، بدون وجود البكتيريا ، يتم القضاء عليها. Without the presence of bacteria, they will be unable to grow and multiply.

READY STOCK



Tagless label

\* Printing Limitations prevent exact fabric and color representation.  
The shades in the lots may differ due to lot-to-lot variations.  
The difference is no more than internationally accepted norms of the garments trade.

**READY STOCK**

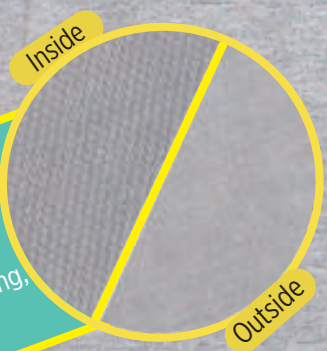

Inside face has texture to enhance moisture management.  
Outside flat texture facilitates excellent decoration results by printing, embroidery work & feels great.



Colours in Ready Stock\*



Charcoal Grey



White



Green



Grey Melange



Black



Royal Blue



Navy Blue



Red

**Item :** BDNC | **Content :** Dryncool fabric with UV protection  
**Measurement :** Gulf | **Sizes Available :** S, M, L, XL, XXL, 3XL

Dryncool is an advanced Moisture Management system (MMS) that helps keep the skin cooler & drier - more comfortable by transporting sweat to outer layer.

Executive wear.

Premium quality.

No-fuss performance.

Creaseless.

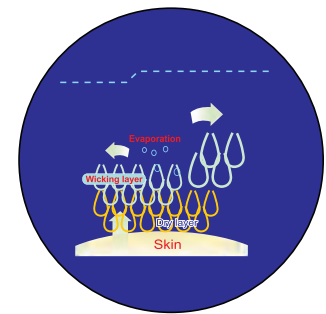
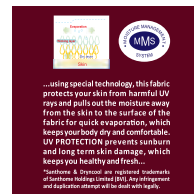

Dryncool Mechanism

**READY STOCK**

UV protection fabrics are rated between UPF 25-39. Ultraviolet protection factor (UPF) measures blockage of UV-A and UV-B rays. A UPF rating of 25-39 means that our fabric allows 1/25th to 1/39th (2.56- 4%) of UV radiation that falls on the surface of the fabric to pass through it. Thus, 96-97.4% of UV rays are not allowed to reach your skin thereby protecting the skin from sunburn and long term skin damage.



Tagless label

**Print Technique :**

- 1 Screen Printing
- 2 Heat Transfer
- 3 Embroidery

**Preferred Print Location :** Max Print Size:  
Left Chest Area / Sleeve 80 x 50 mm

**Care Instructions:**



**Packing:**

52.5x 32.5x 45 cms ; 50 pcs /carton ; gw/nw: 21.5kg / carton  
\* Packing details may have ± 10% variation based on size breakup



Side slits with bartack

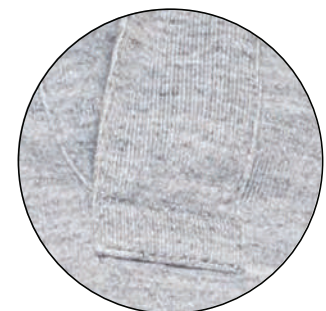

Double placket

\* Printing Limitations prevent exact fabric and color representation.  
The shades in the lots may differ due to lot-to-lot variations.  
The difference is no more than internationally accepted norms of the garments trade.

READY STOCK

Light weight, Special Knit fabric,  
with DrynCool & UV Protection Function



(Colours in Ready Stock\*)



UV protection fabrics are rated between UPF 25-39. Ultraviolet protection factor (UPF) measures blockage of UV-A and UV-B rays. A UPF rating of 25-39 means that our fabric allows 1/25th to 1/39th (2.56- 4%) of UV radiation that falls on the surface of the fabric to pass through it. Thus, 96- 97.4% of UV rays are not allowed to reach your skin thereby protecting the skin from sunburn and long term skin damage.



Distinctive Triple Needle Stitch at seams



Tagless high quality label

READY STOCK

Item : ADF (ALLDAYFRESH) | Content : Dryncool Sports fabric  
Measurement : Gulf | Sizes Available : S, M, L, XL, XXL, 3XL

Print Technique :

- 1 Screen Printing
- 2 Heat Transfer
- 3 Embroidery

Preferred Print Location : Max Print Size:  
Left Chest Area / Sleeve 80 x 50 mm

Care Instructions:



Packing:

51 x 36x 41cm; 50 pcs/carton; gw/nw: 14.2kg/carton  
\* Packing details may have ± 10% variation based on size breakup



Side slits with Bartack



Trendy DTM buttons

\* Printing Limitations prevent exact fabric and color representation. The shades in the lots may differ due to lot-to-lot variations. The difference is no more than internationally accepted norms of the garments trade.

# TECK

READY STOCK



Light weight, Special Knit fabric,  
with DrynCool & UV Protection Function



Why the name Teck? It's Sports garment Technology at its best! In this Knowledge-based world, the users will be the Young and the Not-So-Young who leverage their knowledge in the daytime and like to perform sports and work-outs in the other times.



White / Red



White / Navy Blue



White / Black

UV protection fabrics are rated between UPF 25-39. Ultraviolet protection factor (UPF) measures blockage of UV-A and UV-B rays. A UPF rating of 25-39 means that our fabric allows 1/25th to 1/39th (2.56- 4%) of UV radiation that falls on the surface of the fabric to pass through it. Thus, 96- 97.4% of UV rays are not allowed to reach your skin thereby protecting the skin from sunburn and long term skin damage.



**تيك**  
جافة و باردة  
سائتوم

حماية من الأشعة فوق البنفسجية  
عيش التبريد  
طوال اليوم

**TECK**  
DRYNCOOL  
by  
SANTHOME

UV PROTECTED  
STAY FRESH  
ALL DAY

تحتوي على تقنيات متقدمة من الألياف الجافة والباردة التي تمنحها خاصية مقاومة الماء والشمس. هذا يجعلها مثالية للرياضة والتمارين الرياضية. كما أنها تتميز بخصائصها التي تمنحها الشعور بالبرودة والجفاف. كما أنها تتميز بخصائصها التي تمنحها الشعور بالبرودة والجفاف. كما أنها تتميز بخصائصها التي تمنحها الشعور بالبرودة والجفاف.

Sun rays can be harmful UV rays which cause sunburn and damage to skin. This special polo uses a technology that prevents sunburn, long term skin damage and you can enjoy sun safely.

High MMS (Moisture Management System) technology, this MMS pulls out the moisture away from the skin to the surface of the fabric for quick evaporation, which keeps your body dry and comfortable.

This PERFORMANCE fabric with MMS in the special knit Design works as excellent ventilation for breathability of fabric, making it more comfortable.

\*SANTHOME & FRONTEX are registered trademarks of SantHOME International Limited. Any infringement and distribution without will be dealt with legally.

Item : Teck | Content : Dryncool Sports fabric with UV protection  
Measurement : Gulf | Sizes Available : S, M, L, XL, XXL, 3XL

Print Technique :

- 1 Screen Printing
- 2 Heat Transfer
- 3 Embroidery

Preferred Print Location : Max Print Size:  
Left Chest Area / Sleeve 80 x 50 mm

Care Instructions:



Packing:

51 x 36x 41cm; 50 pcs/carton; gw/nw: 14.2kg/carton  
\* Packing details may have ± 10% variation based on size breakup

\* Printing Limitations prevent exact fabric and color representation.  
The shades in the lots may differ due to lot-to-lot variations.  
The difference is no more than internationally accepted norms of the garments trade.

READY STOCK



Sports design



Tagless high quality label



Trendy DTM buttons

THE GRAND BUCK  
COLLECTION



READY STOCK

Pique Textured cotton rich  
Dryncool performance fabric



# THE GRAND BUCK COLLECTION HIGHLANDER<sup>(i)</sup> POLO SHIRTS FOR ADULTS



## Colours in Ready Stock \*

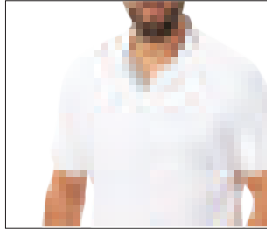

White cloud  
(White / Light melange)

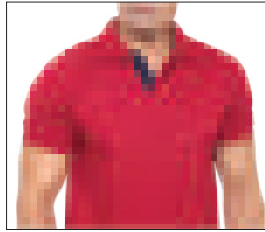

Terracotta  
(Red/Navy)

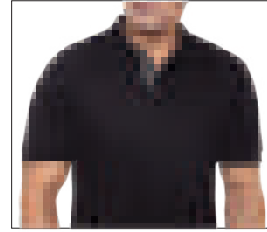

Lava  
(Black/Dark melange)

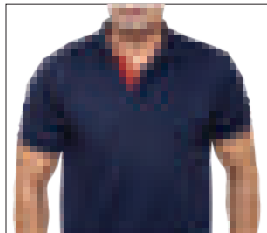

Gulf blue  
(Navy blue/Red)

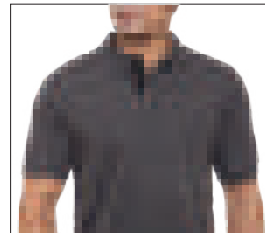

Ebonite  
(Dark melange/Black)

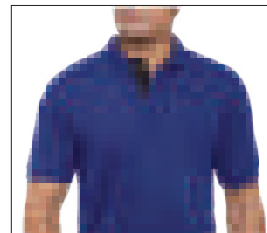

Royal Blue/Black

Item: HIGHLANDER | Content: Cotton rich Dryncool performance fabric  
Measurement: Gulf | Sizes Available: S, M, L, XL, XXL, 3XL

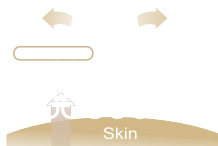

...using special technology this fabric pulls out the moisture away from the skin to the surface of the fabric for quick evaporation, which keeps your body dry and comfortable.

"When you are looking for a performance polo that withstands the daily wash and wear only a HIGHLANDER will meet your expectations.

It has the right feel, fit, weight and the resilience.

This Dryncool material, predominantly composed of cotton, retains its charm - wash after wash"

### Print Technique :

- ① Screen Print
- ② Heat Transfer
- ③ Embroidery

Preferred Print Location : Max Print Size:

Left Chest Area / Sleeve

80 x 50 mm

### Care Instructions:



### Packing:



52.5 x 32.5 x 40cm; 50 pcs/carton; gw/nw: 17kg/carton

\* Packing details may have ± 10% variation based on size breakup

\* Printing Limitations prevent exact fabric and color representation.

The shades in the lots may differ due to lot-to-lot variations.

The difference is no more than internationally accepted norms of the garments trade.



Neck tape & inside  
Placket in contrast



Trendy HORN button



Trendy double placket



Contrast side slits with  
bartack detailing

READY STOCK

(i) HIGHLANDER from the THE GRAND BUCK COLLECTION is manufactured with pride under license from SANTHOME HOLDINGS LTD. ( BVI).

# CARRIBEAN

READY STOCK

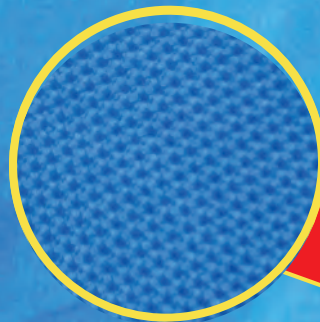

Light-weight Special texture fabric with MMS Technology



### Colours in Ready Stock

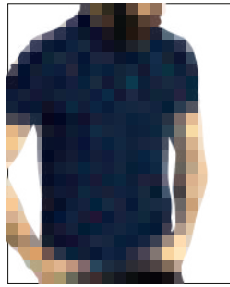

Navy



Black



White



Red

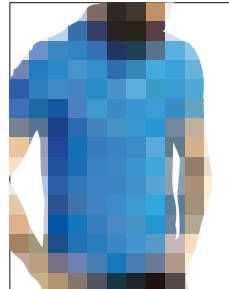

Blue



Grey



Tagless label

READY STOCK

Item : Carribean | Content : 100% Polyester  
 Measurement : Gulf | Sizes Available : XS , S , M , L , XL , XXL , 3XL

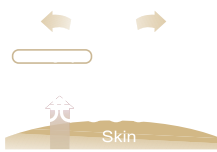

...using special technology this fabric pulls out the moisture away from the skin to the surface of the fabric for quick evaporation, which keeps your body dry and comfortable.

### Print Technique :

- 1 Screen Printing
- 2 Heat Transfer
- 3 Embroidery

Preferred Print Location : Left Chest Area / Sleeve  
 Max Print Size: 80 x 50 mm

### Care Instructions:



### Packing:

51 x 36 x 41 cm; 50 pcs/carton; gw/nw: 14.2kg/carton  
 \* Packing details may have ± 10% variation based on size breakup



Trendy Embossed Button



Contrast Tripple Needle Stitch



Trendy Short Collar

\* Printing Limitations prevent exact fabric and color representation.  
 The shades in the lots may differ due to lot-to-lot variations.  
 The difference is no more than internationally accepted norms of the garments trade.

READY STOCK

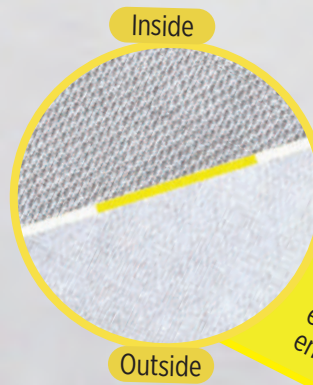

Inside

Outside

Inside face has texture to enhance moisture management.  
Outside flat texture facilitates excellent decoration results by printing, embroidery work & feels great.



### Colours in Ready Stock\*



White - Red / Navy



Black - Red / Grey



Navy - Red / Grey



Grey - Navy / White

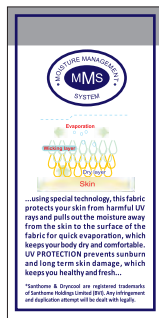

Dryncool is an advanced Moisture Management system (MMS) that helps keep the skin cooler & drier - more comfortable by transporting sweat to outer layer.

Executive wear.

Premium quality.

No-fuss performance.

Creaseless.



Item : Tropikana | Content : Dryncool fabric with UV protection  
Measurement : Gulf | Sizes Available : S, M, L, XL, XXL, 3XL

The subtle combinations of corporate colors on sleeves, collar, placket & pocket give a modern, stylish, yet a corporate look to this polo.

UV protection fabrics are rated between UPF 25-39. Ultraviolet protection factor (UPF) measures blockage of UV-A and UV-B rays. A UPF rating of 25-39 means that our fabric allows 1/25th to 1/39th (2.56- 4%) of UV radiation that falls on the surface of the fabric to pass through it. Thus, **96- 97.4% of UV rays are not allowed to reach your skin** thereby protecting the skin from sunburn and long term skin damage.

### Print Technique :

- 1 Screen Printing
- 2 Heat Transfer
- 3 Embroidery

### Preferred Print Location :

Left Chest Area / Sleeve

### Max Print Size:

80 x 50 mm

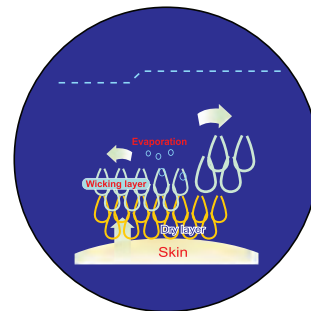

Dryncool Mechanism



Tagless Label

### Care Instructions:



### Packing:



52.5 x 32.5x 45 cm ; 50 pcs /carton ; gw/nw: 16kg / carton

\* Packing details may have ± 10% variation based on size breakup

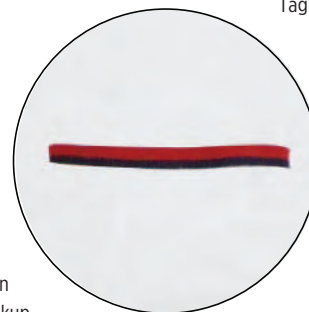

Patchless concealed pocket



Side slits with bartack

\* Printing Limitations prevent exact fabric and color representation.  
The shades in the lots may differ due to lot-to-lot variations.  
The difference is no more than internationally accepted norms of the garment trade.

READY STOCK

*Greberry*



**READY STOCK**





Colours in Ready Stock\*



White / Grey



White / Blue



White / Red

**Greberry**  
a premium polo

A Concept Bordering between  
FASHION & CORPORATE WEAR !

From the  
**SANTHOME**<sup>®</sup>  
Polo collection

SANTHOME is a registered trademark owned by SANTHOME HOLDINGS LTD. (BVI).

- Details :-
- DrynCool fabric
  - UV Protection By Resil
  - Grey Berries for the Design Element
  - Subtle-lined & Berry - infused collar
  - Silicone sleeve tag breaks the monotony
  - The first button thread catches your attention
  - Bottom slit for comfortable postures
  - Frosted Button
  - Regular Fit
- Have we missed anything?

Break out from the routine of standard basic designs, & embrace the new Corporate Fashion Polo; Introducing Greberry by **SANTHOME**

The Grey Berries (of Greberry fame) around the shoulder & on the collar infuse the subtle design aspect without being loud.



UV protection fabrics are rated between UPF 25-39. Ultraviolet protection factor (UPF) measures blockage of UV-A and UV-B rays. A UPF rating of 25-39 means that our fabric allows 1/25th to 1/39th (2.56- 4%) of UV radiation that falls on the surface of the fabric to pass through it. Thus, **96- 97.4% of UV rays are not allowed to reach your skin** thereby protecting the skin from sunburn and long term skin damage.



Berries on sleeve

READY STOCK

Item : Greberry | Content : Dryncool Sports fabric with UV protection  
Measurement : Gulf | Sizes Available : S, M, L, XL, XXL, 3XL

### Print Technique :

- 1 Screen Printing    2 Heat Transfer    3 Embroidery

Preferred Print Location : Max Print Size:  
Left Chest Area / Sleeve    80 x 50 mm

### Care Instructions:



### Packing:



52.5 x 32.5 x 45 cms ; 50 pcs /carton ; gw/nw: 16kg / carton  
\* Packing details may have + 10% variation based on size breakup



Trendy silicon brand tag



Frosted top button with contrast color stitch

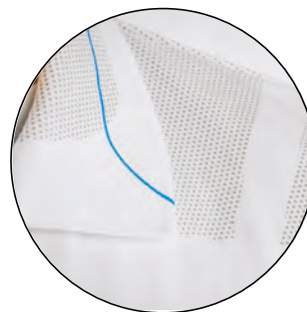

Collar design

\* Printing Limitations prevent exact fabric and color representation. The shades in the lots may differ due to lot-to-lot variations. The difference is no more than internationally accepted norms of the garments trade.



EXCLUSIVE QUALITY 2PLY  
100% COTTON REGLAN POLO SHIRTS

# REGLAN

REGLAN



Colours in Ready Stock\*



White / Royal Blue



White / Navy Blue



2 ply ring special yarn ensure lasting feel & Performance



White / Red

READY STOCK

**SANTHOME**  
BY  
**SELECT**  
Since 1989

100% cotton. 260 GSM 2 ply super combed pique polo.. ie. same as MACY fabric. Trendy Executive Wear. Premium quality comparable to brands. Performance for colour fastness, shrinkage and shape retention. Collar/Cuff has contrast tipping. Reglan sleeves has contrast piping.

Item : REGLAN Polo | GSM : 260/265

Content : 100% cotton. 2ply Premium super combed yarn

Measurement : Gulf | Sizes Available : S, M, L, XL, XXL

Print Technique :

- ① Screen Printing
- ② Heat Transfer
- ③ Embroidery

Preferred Print Location : Max Print Size:

Left Chest Area / Sleeve

80 x 50 mm

Care Instructions:



Packing:



56.5 x 34x 42.5 cm ; 50 pcs /carton ; gw/nw: 19.2kg / carton

\* Packing details may have ± 10% variation based on size breakup

\* Printing Limitations prevent exact fabric and color representation.

The shades in the lots may differ due to lot-to-lot variations.

The difference is no more than internationally accepted norms of the garment trade.



Trendy embossed buttons

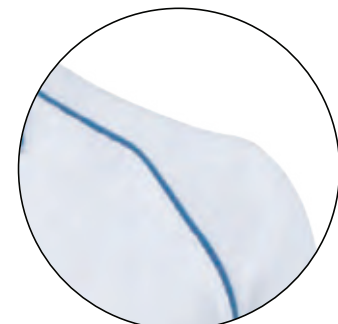

Contrast piping and tipping





Double pique texture in two ply ensures lasting feel and performance, wash after wash.

Colours in Ready Stock \*

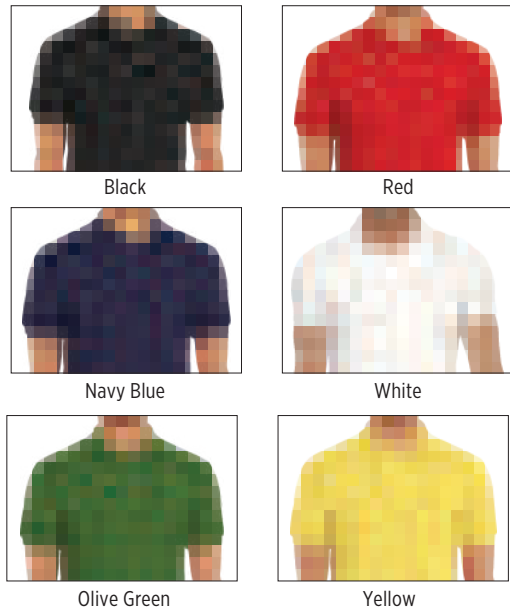

**2 PLY**  
Ring Spun  
yarn

2 ply ring special yarn ensure lasting feel & Performance

READY STOCK

Item: Macy | GSM : 260/265 | Content : 100% cotton. 2ply premium super combed yarn | Measurement : Gulf | Sizes Available : S, M, L, XL, XXL - Black, Navy Blue, Red, L, XL, XXL - Olive Green, Yellow, White



100% cotton. 260 GSM 2 ply super combed pique polo shirt.

Premium quality comparable to top brands.

Performance for colour fastness, shrinkage and shape retention - wash after wash.

Well knit collar and cuff for stability, smart buttons, side slits for added comfort.



Print Technique :

- 1 Screen Printing
- 2 Heat Transfer
- 3 Embroidery

Preferred Print Location : Max Print Size:  
Left Chest Area / Sleeve 80 x 50 mm

Care Instructions:



Packing:

56 x 34x 39 cms ; 50 pcs /carton ; gw/nw: 20kg / carton  
\* Packing details may have ± 10% variation based on size breakup



Trendy embossed buttons

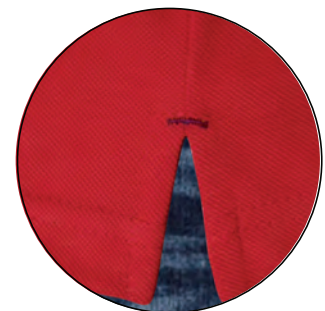

Side slits with bartack

\* Printing Limitations prevent exact fabric and color representation. The shades in the lots may differ due to lot-to-lot variations. The difference is no more than internationally accepted norms of the garment trade.

# GOLF POLOS

READY STOCK

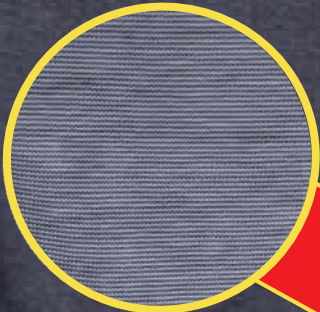

Two tone all weather fabric



Colours in Ready Stock\*

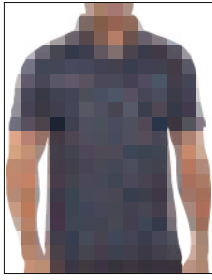

Navy Blue

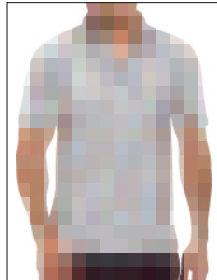

Anthra

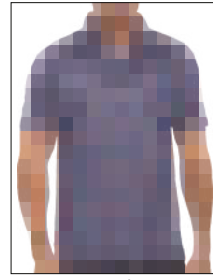

Purple  
Toned Burgundy



Beige

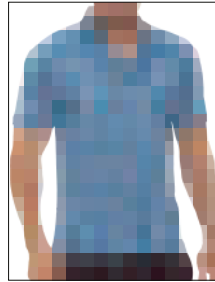

Sky Blue

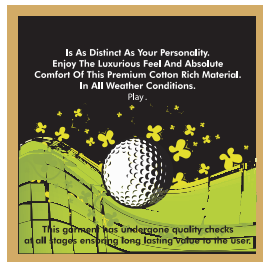

Premium Golf Polo in pre-dyed yarn. Quality comparable to top brands. Collar is high quality jacquard in yarn dyed. Collar band and Placket in biased contrast stripes matching to body.

Item : Golf Polo Limited Edition | Content : Pre-Dyed Two Tone, all-weather fabric.  
Measurement: Gulf | Sizes Available : S, M, L, XL, XXL, XXXL

Print Technique :

- 1 Screen Printing
- 2 Heat Transfer
- 3 Embroidery

Preferred Print Location : Max Print Size:  
Left Chest Area / Sleeve 80 x 50 mm

Care Instructions:



Packing:

56x 36x 36cms ; 50 pcs /carton ; gw/nw: 15.30kg / carton  
\* Packing details may have + 10% variation based on size breakup

\* Printing Limitations prevent exact fabric and color representation. The shades in the lots may differ due to lot-to-lot variations. The difference is no more than internationally accepted norms of the garment trade.



High quality pre - dyed Jacquard collar in matching body color

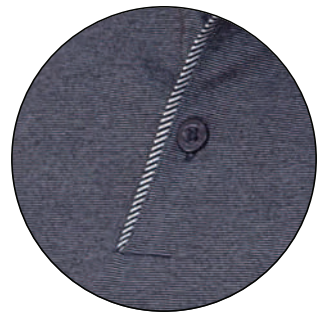

Matching biased placket and edge piping

READY STOCK

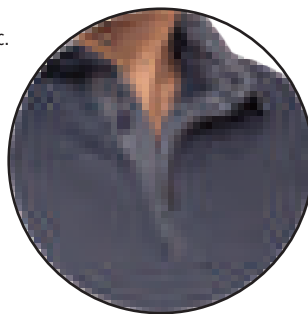

Matching collar band



Freedom sleeves, no cuffs

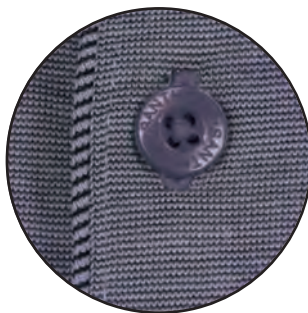

Embossed buttons

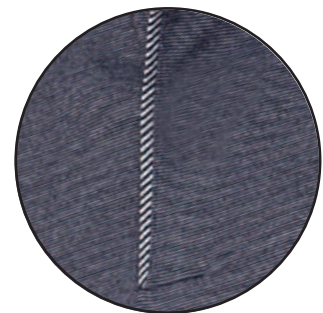

Thick needle stitch at end-of-placket



# ORCA<sup>[i]</sup> MERCERIZED GOLF POLO SHIRTS

Colours in Ready Stock\*



Cobra  
(Khaki/Black)



Midnight Sky  
(Navy/Khaki)

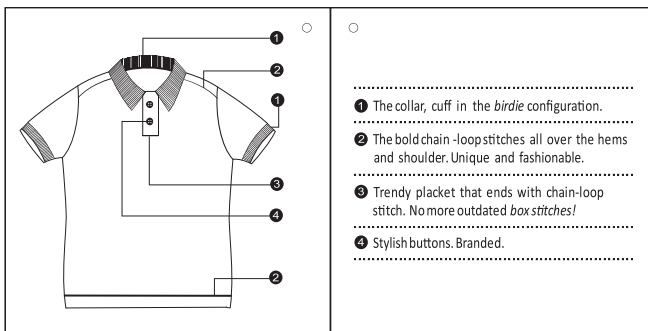

READY STOCK

"ORCA is found in Antarctica and Arctic oceans. Also called 'Killer Whales', it is the largest of the Dolphin family. They are beautiful, intelligent, fast, strong and yet the most social of all sea animals! They are said to have great tolerance in varying temperatures. That is the reason they enjoy world-wide distribution. Most interestingly, it's the only species in the world that has both the male and the female offspring stay with their mothers and immediate family forever...!"



These wonderful creatures have inspired us to bring to you exclusive polos. Their 'killer look', beauty, sheen and lustre is attributed to the MERCERIZING process. The premium cotton rich material makes it extremely comfortable in all climatic conditions. The collar, cuff in the birdie configuration sets new standards in their making. The bold loop stitches all over the hems and shoulder make them unique and yet resilient. Finally just as the ORCA, this polo will stay with you for long time to come.

Shouldn't then it be called the ORCA POLO?"

**Item :** ORCA | **Content :** Premium Cotton rich MERCERIZED fabric  
**Measurement :** Gulf | **Sizes Available :** S, M, L, XL, XXL, 3XL

### Print Technique :

- 1 Screen Print
- 2 Heat Transfer
- 3 Embroidery

**Preferred Print Location :** Max Print Size:

Left Chest Area / Sleeve      80 x 50 mm



### Care Instructions:

#### Packing:



56 x 36x 40 cm ; 50 pcs /carton ; gw/nw: 15.7kg / carton

\* Packing details may have +10% variation based on size breakup



Unique bold loop stitching at end of placket

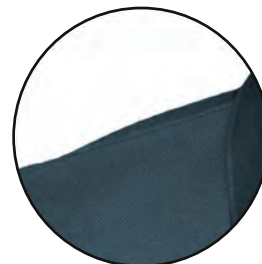

Unique bold loop stitching on shoulder & all hems



Unique birdie configuration collar/cuff



Thick side embossed button

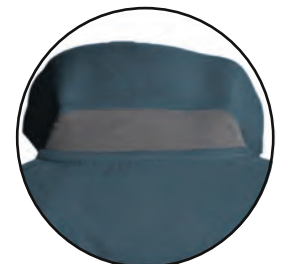

Trendy 'Picaso' collar

\* Printing Limitations prevent exact fabric and color representation. The shades in the lots may differ due to lot-to-lot variations. The difference is no more than internationally accepted norms of the garment trade.

[i] Orca is manufactured under license from SANTHOME HOLDINGS LTD. (BVI).

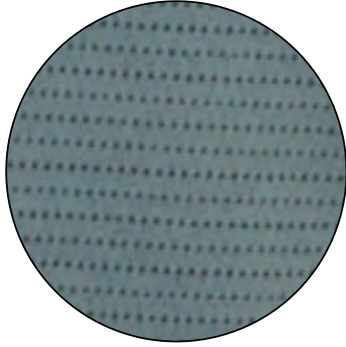

Special textured 2-tone knit fabric



- Swing+ Tech swing support mechanism
- Enhanced stretch for better range of motion
- UV protection against harmful UV sunlight
- Moisture wicking DryNCool® fabric
- Lightweight fabric

**READY STOCK**

**سانديز اند بت**  
من  
**سانتوم**  
غولف • ليجاسي

حماية من الأشعة فوق البنفسجية  
أبقى منتعشاً

**Sandies & Putt**  
by  
**SANTHOME**  
Golf • Legacy

UV Protected  
Stay Fresh

\* تحتوي اشعة الشمس على الاشعة فوق البنفسجية الضارة ، و التي تسبب في حروق الشمس و تحترق بالبشرة. مع هذا القميص الخاص من بولو يتم استخدام تكنولوجيا تعمل على منع حروق الشمس، الاضرار المزمنة التي تحدث للبشرة حتى تتمكن من الاستمتاع بالشمس في امان.

\* و باستخدام تقنية (نظام معالجة الرطوبة) ، يقوم هذا النسيج بطرد الرطوبة بعيدا عن البشرة الى سطح النسيج حيث يتبخر سريعا مما يحافظ على جفاف و راحة جسمك.

\* باتيكم هذا النسيج المصنع بتقنية نظام معالجة الرطوبة في تصاميم مميزة و يعمل بطريقة ممتازة على التهوية بالنسيج مما يجعله اكثر راحة.

**معالجة الرطوبة**  
نظام  
**MMS**

**سانتوم** و **دراي اند كول** هي علامات تجارية مسجلة لـ **سانتوم** القابضة المحدودة (جزر فيرجين البريطانية) سوف يتم التعامل بطريقة قانونية مع اي انتهاك أو محاولة للتقليد

\* Sun rays contain harmful UV rays which cause sunburn and damage to skin. This special polo uses a technology that prevents sunburn, long term skin damage and you can enjoy sun safely.

\* Using MMS (Moisture Management System) technology, this fabric pulls out the moisture away from the skin to the surface of the fabric for quick evaporation, which keeps your body dry and comfortable. This PERFORMANCE fabric with MMS in the special Knit Design works as excellent Ventilation for free breathing of fabrics, making it more comfortable.

**MOISTURE MANAGEMENT SYSTEM**  
**MMS**

\*Santhome & Dryncool are registered trademarks of Santhome Holding Limited (BVI). Any infringement and duplication attempt will be dealt with legally.

Item : SNP

Content : 100% polyester, Special Knit

Measurement : Gulf Sizes Available : S, M, L, XL, XXL, 3XL

Print Technique :

1 Screen Printing 2 Heat Transfer 3 Embroidery

Preferred Print Location : Left Chest Area / Sleeve

Max Print Size: 80 x 50 mm



# DRYNCOOL EXCLUSIVE QUALITY POLO SHIRTS



Colours in Ready Stock



White



Black

READY STOCK

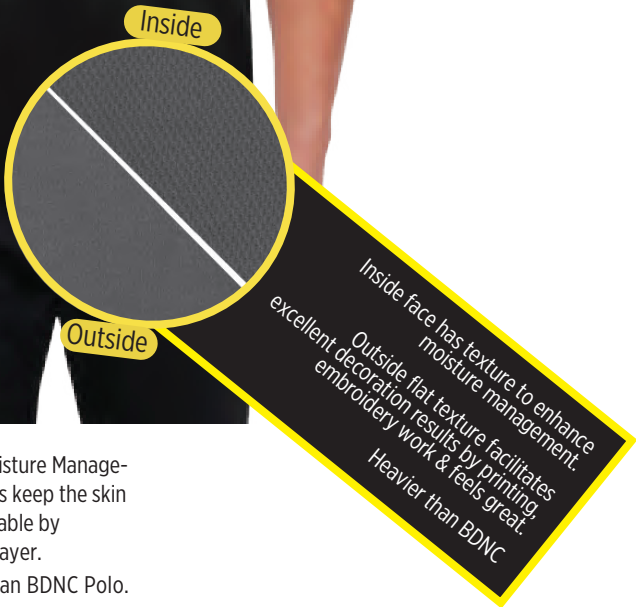

Dryncool is an advanced Moisture Management system (MMS) that helps keep the skin cooler & drier- more comfortable by transporting sweat to outer layer. Premium Quality Heavier than BDNC Polo. No fuss Performance. Creaseless. Contrast tape on button placket. Contrast neck tape highlighting the style. Authentic MMS logo

Item: EDNC | Content: Dryncool fabric  
Measurement: Europe | Sizes Available: S, M

### Print Technique :

- 1 Screen Printing
- 2 Heat Transfer
- 3 Embroidery

Preferred Print Location :

Left Chest Area / Sleeve

Max Print Size:

80 x 50 mm

### Care Instructions:



### Packing:

52.5 x 32.5 x 42.5 cms ; 50 pcs /carton ; gw/nw: 18kg / carton  
\* Packing details may have ± 10% variation based on size breakup

\* Printing Limitations prevent exact fabric and color representation. The shades in the lots may differ due to lot-to-lot variations. The difference is not more than internationally accepted norms of the garments trade.

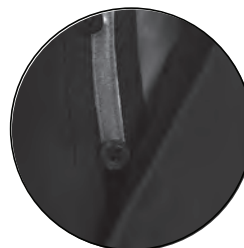

Contrast flat piping on inside placket



Side slits with contrast, bartack



Contrast piping on shoulder & cuff

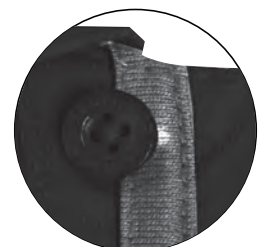

Trendy embossed buttons

# SAILOR COTTON POLO SHIRTS



SAILOR



Colours in Ready Stock\*



White



Cream



Yellow



Red



Navy Blue



Grey Melange



Sky Blue



Orange



B-Green



Black



Ash Melange



Royal Blue

READY STOCK



E-Green



Maroon

Item : SAILOR POLO | GSM : 220 gsm | Content : 100 % cotton  
 Sizes Available: S, M, L, XL, XXL

Regular pique polo for mass distribution

### Print Technique :

- 1 Screen Printing
- 2 Heat Transfer
- 3 Embroidery

Preferred Print Location : Max Print Size:  
 Left Chest Area / Sleeve 80 x 50 mm

### Care Instructions:



### Packing:



58x 29x 40cm; 50pcs/carton; gw/nw: 22kg/carton  
 \*Packing details may have ± 10% variation based on size breakup



\* Printing Limitations prevent exact fabric and color representation.  
 The shades in the lots may differ due to lot-to-lot variations.  
 The difference is no more than internationally accepted norms of the garments trade.



## BRAND NAME POLO SHIRTS



### Ace Jacquard Polo with Bamboo

2 Tone fabric of 65% polyester and 35% rayon nanobon. 2 Button placket with embossed buttons. 1 x 1 flat knit rib collar. Necktape. Slide slits/ PGA tour print at the sleeve.

Sizes: S, M

Print Technique : Sc, HT, Embroidery Preferred Print Location : Left Chest Area / Sleeve Max Print Size: 80 x 50 mm

Packing Details : 58 x 35 x 24cm; 40 pcs/carton; gw/nw: 12.5 kg/carton

\* Packing details may have ± 10% variation based on size breakup

READY STOCK



Red



### Colours in Ready Stock \*

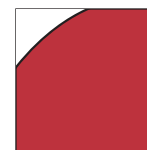

Red



Black

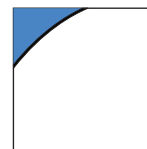

White

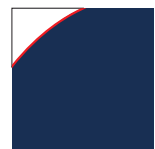

Navy

Pique knit of 100% combed cotton. GSM: 200-220. Reglan sleeves. 1 x 1 Flat knit rib collar. Contrast coloured piping on reglan sleeves. 2 Button placket with engraved tone on tone buttons. Self fabric necktape. Slazenger embroidery on backside. Embroidered main label at inside halfmoon.

Compliance : AZO, Formaldehyde, PCP, Uses non-carcinogenic dyestuff, APEO.

Sizes: Red - S, M, L, XL, XXL

Black, White, Navy - S, M

Print Technique : Sc, HT, Embroidery Preferred Print Location : Left Chest Area / Sleeve Max Print Size: 80 x 50 mm

Packing Details : 51 x 32 x 27cm; 30 pcs/carton; gw/nw: 9.5 kg/carton

\* Packing details may have ± 10% variation based on size breakup





White



Grey

100% Cotton long sleeve shirt with DuPont Teflon fabric protector. Breathable, Durable, Safe, Gentle fabric with Oil repellance & Stain resistance by *Tonino Lamborghini*

Print Technique : SC, HT, EMBROIDERY Preferred Print Location : Left Chest Area / Sleeve Max Print Size: 80 x 50 mm

Packing Details : 56.5 x 34x 42.5 cm ; 50 pcs /carton ; gw/nw: 19.2kg / carton Size: XS - XL

\* Packing details may have ± 10% variation based on size breakup

READY STOCK



Cream



Black



Navy Blue

Polo Shirts- 100% cotton short sleeve by *Tonino Lamborghini*

Print Technique : SC, HT, EMBROIDERY Preferred Print Location : Left Chest Area / Sleeve Max Print Size: 80 x 50 mm

Packing Details : 48 x 33x 42.5 cm ; 40 pcs /carton ; gw/nw: 16.4kg / carton Size: M, L, XL

\* Packing details may have ± 10% variation based on size breakup



# GIORDANO EASY CARE SHIRTS



Regular Fit

Antibacterial

This item has been treated with antibacterial properties, helping it stay fresh against common bacteria, such as Golden Staph, E. Coli and Candida Albicans.

Easy iron

100% Cotton Oxford Fabric

It offers superior hand feel.

Button Down Collar, with patch pocket at chest

Shirt designed as formal with comfort anytime & anywhere

Wrinkle Free treated to avoid crinkles and keeps it fresh

Mechanical stretch imparted on fabric to suit the body

Available in Short Sleeve & Long Sleeve in White & Blue Colours.

READY STOCK





Red

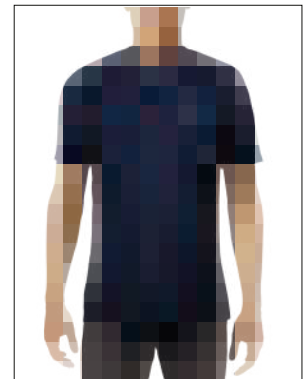

Ink Blue

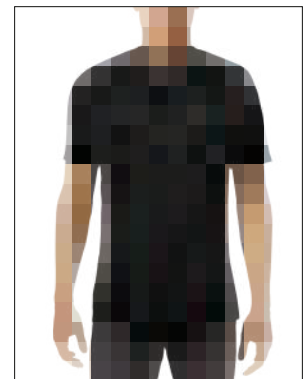

Black

READY STOCK

Item : SALAMA | Content : 100% Polyester  
Measurement : Gulf | Sizes Available : S, M, L, XL, XXL, 3XL

Print Technique :

- 1 Screen Printing
- 2 Heat Transfer
- 3 Embroidery

Preferred Print Location : Max Print Size:  
Left Chest Area / Sleeve 80 x 50 mm

Care Instructions:



Packing:



\* Packing details may have ± 10% variation based on size breakup



\* Printing Limitations prevent exact fabric and color representation.  
The shades in the lots may differ due to lot-to-lot variations.  
The difference is no more than internationally accepted norms of the garments trade.

READY STOCK



Premium Cotton fabric with super hand feel and smoothness



### Colours in Ready Stock\*

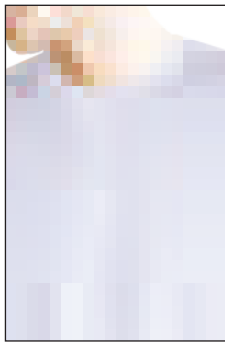

White

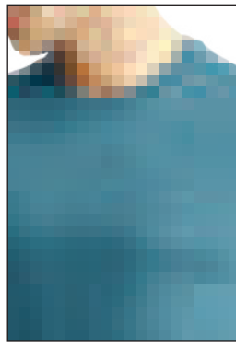

Petrol

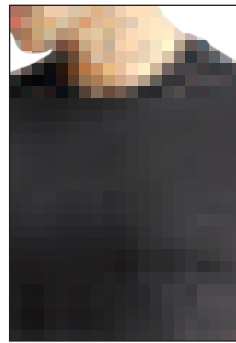

Black



Orange

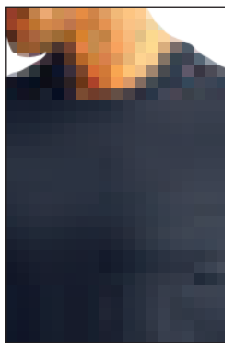

Navy Blue

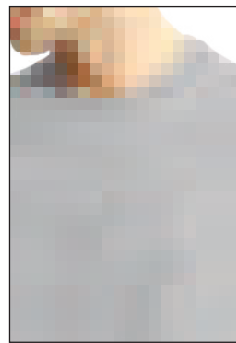

Ash melange

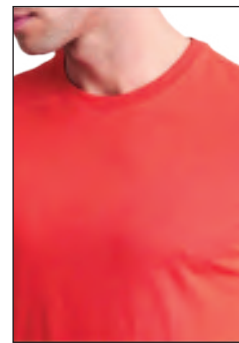

Red

Item : BIO 180 | GSM : 180 | Content : 100% cotton. Super combed with Bio - Enzyme | Measurement : Gulf | Sizes : S, M, L, XL, XXL, 3XL

This Premium cotton T shirt uses high quality LONG STAPLE cotton from Central India.

This ensures superior consistency of the yarn it is spun from. Resultant fabric knitted shows the rich handfeel and luxury of COTTON we love. BIO process adds further to the smooth and soft luxury one would never want to come out of...!

#### Print Technique :

- 1 Screen Printing
- 2 Heat Transfer
- 3 Embroidery

Preferred Print Location : Max Print Size:  
Left Chest Area / Sleeve 80 x 50 mm

#### Care Instructions:



#### Packing:



52x 32.5x 50 cm ; 100 pcs /carton ; gw/nw: 21.5kg / carton  
\* Packing details may have ± 10% variation based on size breakup

\* Printing Limitations prevent exact fabric and color representation. The shades in the lots may differ due to lot-to-lot variations. The difference is no more than internationally accepted norms of the garment trade.



Tagless main label

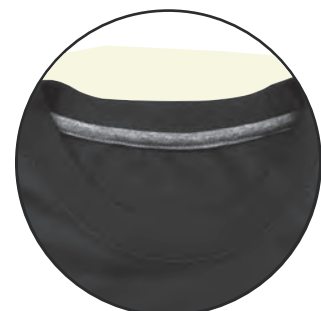

Contrast neck tape

READY STOCK



# T-SHIRTS & SWEATER

ORIGINAL  
**SELECT**  
QUALITY



Royal Blue



Orange



Sky Blue



Black



E-Green



B-Green



Red



Pink



White



Navy Blue



Grey Melange



Yellow



Beige



Maroon

Item: SELECT 180 | GSM: 180 gsm | Content : 100% COTTON

Sizes Available : S, M, L, XL, XXL

Regular round neck t-shirts for mass distribution

Print Technique : SC, HT, EMB Preferred Print Location : Left Chest Area Sleeve Max Print Size : 80 x 50mm

Packing Details : 58 x 38 x 35cm; 100 pcs/carton; gw/nw: 21.5kg/carton

\* Printing Limitations prevent exact fabric and color representation.

The shades in the lots may differ due to lot-to-lot variations.

The difference is not more than internationally accepted norms of the garments trade. \* Packing details may have ± 10% variation based on size breakup

READY STOCK

## SANTHOME

SWEATER



100% Acrylic

Cashmere Like

Sweater for  
winter, autumn  
& spring

SANTHOME SWEATER

Print Technique : Embroidery Preferred Print Location : Left Chest Area  
Max Print Size: 80 x 50 mm Size: M - XXL

\* Printing Limitations prevent exact fabric and color representation.

The shades in the lots may differ due to lot-to-lot variations.

The difference is not more than internationally accepted norms of the garments trade.

\* Packing details may have ± 10% variation based on size breakup



Blanket-200 GSM

Print Technique : SC (Cover) Preferred Print Location : Center  
Max Print Size : 200 x 120 mm Product Size : 140 x 180 cm

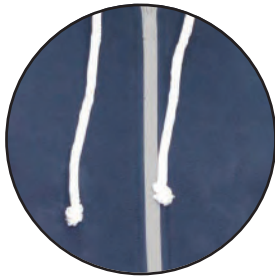

Contrast Zippers and drawstrings



Navy



Black



Inner hood in contrast



Kangaroo pockets.



Subtle embossed grommets

Hoody without zipper



Navy



Black

Hoody with zipper

READY STOCK

**Item:** SANTHOME IGLOO collection – Hoodies  
**Content:** Cotton rich Soft single fleece.  
**Measurement:** Gulf | **Sizes Available :** S, M, L, XL, XXL, XXXL

SANTHOME IGLOO Collection Hoodies are made from high quality single fleece. The inside is brushed which keeps you warm. The outer is plain and smooth. Contrasting Trims add to the elegance. Kangaroo pockets that keep your hands cozy. These hoodies make a perfect outdoor must have!  
 Print Technique : SC, HT, EMB Preferred Print Location : (Zipper) Front Pocket Max Print Size : 80 x 50 mm  
 Packing Details : 52 x 51 x 33cm; 25 pcs/carton; gw/nw: 15kg/carton



**ADDO**  
 Addo hooded sweatshirt with full zipper. In combination of cotton and polyester materials of 280g/m2. With matching color cords and 2 front pockets. Available in sizes S, M, L, XL, XXL.  
 Print Technique : SC, EMB Preferred Print Location : Front & Back Max Print Size : 330 x 200 mm  
 Packing Details : 40 X 48 X 60 cms ; 20 kg Pcs: 25/ carton

\* Packing details may have +10% variation based on size breakup



# SANTHOME

SANTHOME Deluxe pique mesh spandex fitted cap



Navy blue/White sandwich



Cream / Black sandwich



Black/White sandwich



Red/Black sandwich

- > One Size Fits All
- > Excellent Shape Retention Even After Multiple Uses
- > Contrast Color Sandwich On Front
- > Fabric With Pores For Air Ventilation

READY STOCK

SC 105

Print Technique : HT, Embroidery

Preferred Print Location : Front / Back

Max Print Size: 45 x 35 mm

Packing Details : 62x 36 x 56 cms ; 150 pcs /carton ; gw/nw: 16.5 kg / carton

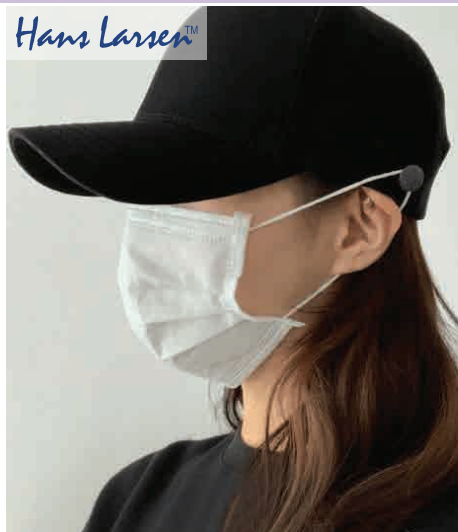

Navy



Releases pressure off the ear when wearing mask !! Helps fight Covid-19

White



Black



KATHU

HWHL 187 - Black HWHL 188 - White HWHL 189 - Navy

Hans Larsen™ Heavy Brushed 6 Panel Classic cotton cap with button that allow you to put the mask straps around the buttons instead of your ears, a more comfortable way to wear face cover!

Print Technique : HT, SC, EMROIDERY

Preferred Print Location : Front

Max Print Size : 80 x 30 mm





Navy Blue

White

Black

**SAY NO TO GREENWASHING**

*Tell the true story of sustainability with genuine recycled rPET and cotton with validated claims.*

Certified by Global Recycled Standard

**GIFTS THAT GIVE BACK**

785 million people - 1 in 9 - lack access to safe water. We are supporting Water.org to change this.

For each IMPACT cap sold, 2% of sales is donated by the Xindao B.V. (Netherlands) to Water.org to save lives with safe water and sanitation.



READY STOCK

- > 2% of sales proceeds of each product committed to Water.org
- > Made of 100% recycled materials

- > Made with AWARE™ tracer
- > This cap saved 387 litres of water

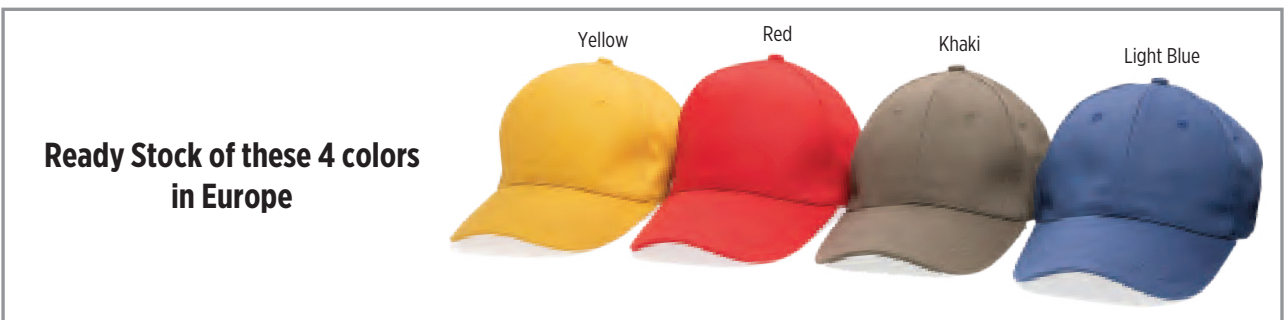

280 gr Recycled Cotton Cap with Aware Tracker - XD Impact Collection

HWAW 451 - Black HWAW 452 - White HWAW 453 - Navy Blue

**XD COLLECTION** No greenwashing, but telling a true story about sustainability! This Impact collection is made with AWARE™ tracer. With AWARE™, the use of genuine recycled fabric materials and water reduction impact claims are guaranteed by using the AWARE disruptive physical tracer and blockchain technology. Save water and use genuine recycled fabrics. With the focus on water 2% of proceeds of sold Impact product has been donated to Water.org. This cap has saved 387 litres of water. A simple and comfortable cap suited for anyone. This 6 panel cap has a curved visor, embroidered eyelets for ventilation and metal buckle. Cotton twill made of 100% recycled materials and AWARE™ tracer. The material weight is 280 g/m2. Size 58cm.

Print Technique : HT, SC, EMBROIDERY  
Product Size: 58 cm

Preferred Print Location : Front  
Packing Details : 36.5 X 45.5 X 69.5 cms ; 200 pcs / carton ; gw / nw : 17 kg / carton

Max Print Size : 45 x 35 mm



# HIGH QUALITY SPORTS CAPS KIDS CAPS



DELANO

SCMK 101- White SCMK 102- Red SCMK 103- Blue

5 panel kid cap in bright colors. In 100% cotton material, with embroidered ventilation holes and adjustable velcro closure.

Print Technique : SC,EMB Preferred Print Location : Front Max Print Size : 80 x 45 mm

Packing Details : 64 X 40 X 44 cm ; 15 kg Pcs: 300/ carton

READY STOCK

## SANTHOME 'de Genève'

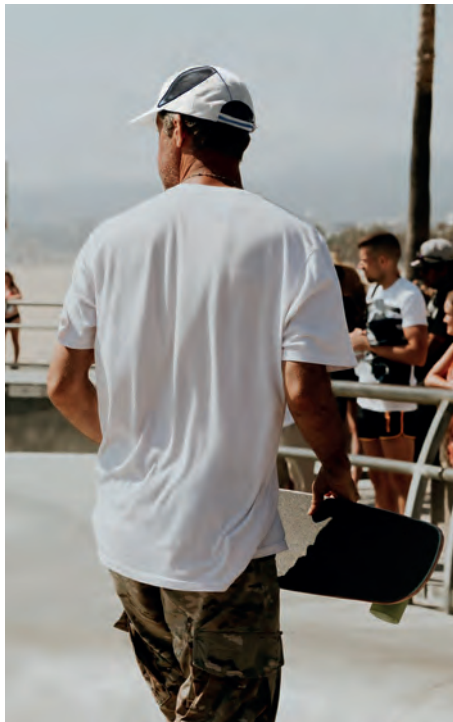

These exclusive quality caps carry this **SANTHOME** logo 'de Genève'



White/Red



White/Pink



White/Navy Blue



White/Maroon



SC 101 SANTHOME Performance / Sports Caps

Print Technique : HT, SC, EMBROIDERY Preferred Print Location : Front

Max Print Size: 80 x 30 mm

Packing Details : 54 x 44 x 44 cm; 144 pcs/carton; gw/nw: 11 kg/carton

\* Packing details may have + 10% variation based on size breakup

# HIGH QUALITY HEAVY BRUSHED COTTON CAPS



White



Black



Navy Blue



Grey



White with  
Black sandwich



Light Grey with  
Navy blue peak and Grey sandwich

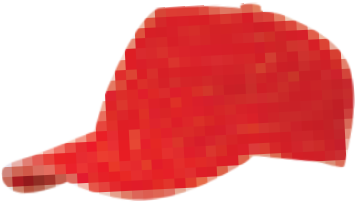

Red with  
White sandwich



Black with Red sandwich



Black with  
Grey sandwich

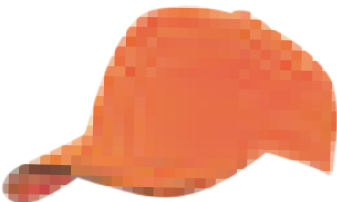

Orange with  
Black sandwich

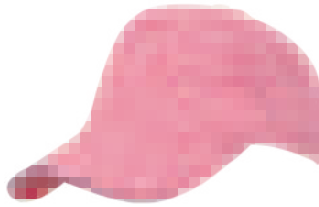

Pink with  
Purple sandwich



White with  
Royal Blue sandwich



Navy Blue with  
Grey sandwich



Maroon

READY STOCK

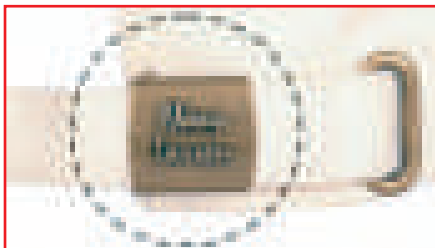

100% Heavy brushed cotton cap with metal buckle

The best quality caps carry this  
*Hans Larsen* logo



**IMPACT**

For each product sold we have donated 2% of proceeds to support Water.org to change lives with safe water.

**THIS PORTFOLIO IS MADE OF 7 RECYCLED WATER BOTTLES**



**THIS PORTFOLIO NOTEBOOK SAVED 4L WATER**

785 million people — 1 in 9 — lack access to safe water

We are supporting Water.org to change this.



Xindao B.V.  
The Netherlands

For more info visit: [www.theimpactcollection.org](http://www.theimpactcollection.org)

READY STOCK



Features -



Confirms to the Cadmium Directive 91 | 338 | EC



U.S. Lead content compliance



Free from single & multichain chlorinated paraffins

NBAW 454 - Black NBAW 455 - Anthracite NBAW 456 - Navy Blue

XD COLLECTION No greenwashing, but telling a true story about sustainability! This Impact collection is made with AWARE™ tracer. With AWARE™, the use of genuine recycled fabric materials and water reduction impact claims are guaranteed, by using the AWARE disruptive physical tracer and blockchain technology. Save water and use genuine recycled fabrics. If you choose this item you save 4 litres of water and 7 plastic bottles have been reused. With the focus on water, 2% of proceeds of each Impact product sold is donated to Water.org. Keep all your work essentials organised with the A5 AWARE™ RPET portfolio. Inside the portfolio you can find a matching notebook. The notebook contains 64 sheets/128 sheets cream coloured lined 80gm/s FSC recycled paper. Inside you will find 1 big sleeve pocket, a phone pocket, 2 card slots and pen loop. Interior and exterior 100% recycled polyester with AWARE™ tracer. PVC free.

Print Technique : SC Preferred Print Location : Front Max Print Size : 100 x 80 mm Product Size : 2.1 x 17.2 x 22.2 cm Packing Details : 26.5 X 37.5 X 39.5 cms ; 20 pcs / carton ; gw / nw : 11 kg / carton



START  
TELLING  
YOUR STORY

AN ORIGINAL BRAND

Leverage Your Brand  
The Corporate Idea

Scan Below QR  
code to watch  
product video

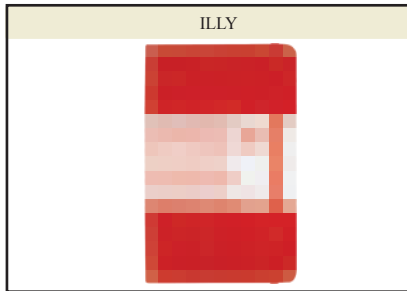
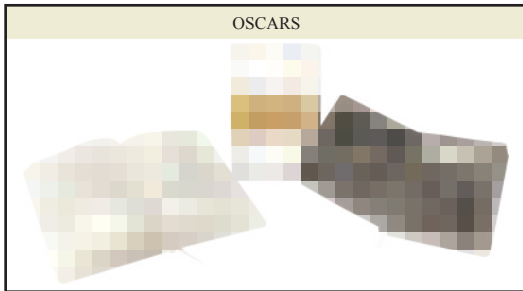
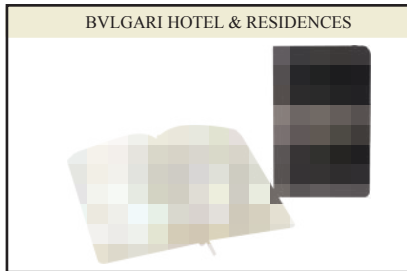

For additional details please refer to the Customization Guidelines

Moleskine notebooks are books to be written and our writing instruments fuel to communicate. They offer simple, thoughtfully designed, functional objects that can be turned into powerful communicators for the world's best brands. Start telling your story.



# MOLESKINE CLASSIC COLLECTION



## NOTEBOOK SIZES



**X-Large**  
192 pages  
19 × 25 cm  
7 1/2" × 9 3/4"



**Large**  
240 pages  
13 × 21 cm  
5" × 8 1/4"



**Medium**  
208 pages  
11.5 × 18 cm  
4 1/2" × 7"



**Pocket**  
192 pages  
9 × 14 cm  
3 1/2" × 5 1/2"



CLASSIC NOTEBOOK FEATURES

- > Hard or soft cover, rounded corners, elastic closure
- > Ribbon bookmark
- > Expandable inner pocket in cardboard and cloth
- > Front endpaper with 'in case of loss' notice
- > Ivory-coloured 70 g/m<sup>2</sup> acid-free paper
- > Elastic closure, ribbon bookmark, innerpocket fabric matches cover colour



OWMOL 311  
Slate Grey



OWMOL 313  
Citron Yellow



OWMOL 314  
Orchid Purple

Large ( 13 x 21 cm ) - Hard Cover - Ruled Notebooks



OWMOL 304  
Black



OWMOL 305  
Red



OWMOL 306  
Navy Blue

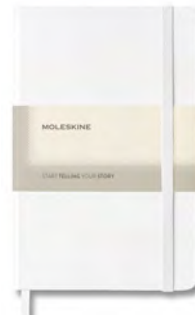

OWMOL 307  
White

Scan Below QR code to watch product video

READY STOCK

Packing Details : 46 X 33 X 24 cm ; 48 pcs / carton ; gw / nw : 17.5 kg / carton



19 x 25 cm (XL)



13 x 21 cm (L)

The Moleskine Professional

- > Available in Large and XL sizes
- > Hard Cover, Rounded Corners, Elastic Closure, Chlorine-free
- > Exclusive Layout Dedicated To Professional Note Taking
- > Initial Pages Dedicated To: Contents, Key Tasks, Project-Planning, Personal And Group Goals
- > Numbered Pages

Last section with detachable pages and to-do lists

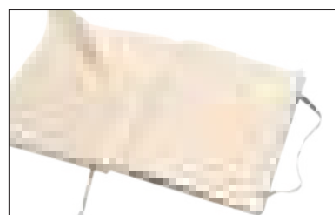

Adhesive tabs and labels for spine or cover



MOLESKINE PROFESSIONAL NOTEBOOKS

OWMOL 320 - 19 x 25 cm (XL) OWMOL 321 - 13 x 21 cm (L)

Stay on top of your work, wherever it takes you. Take satisfaction from detaching a completed to-do list, find your notes easily with the index and numbered pages, and keep all your travel receipts, business cards and hand-outs secure in the double expandable back pocket.

Product Size (XL) : 19 x 25 cm

Packing Details : 28 x 23.5 x 43.5 cm ; 24 pcs /carton ; gw/nw : 13.4 kg / carton

Product Size (LARGE) : 13 x 21 cm

Packing Details : 30.5 x 26 x 47 cm ; 48 pcs /carton ; gw/nw : 16.32 kg / carton



Large (13 × 21 cm) - Hard Cover - Plain Notebooks



OWMOL 309

Large (13 × 21 cm) - Soft Cover - Ruled Notebooks



OWMOL 308 - Black



OWMOL 319 - Sapphire Blue

Packing Details : 46 X 33 X 24 cm ; 48 pcs / carton ; gw / nw : 17.5 kg / carton

Packing Details : 44 X 31 X 24.5 cm ; 64pcs / carton ; gw / nw : 17 kg / carton

READY STOCK

XL (19 × 25 cm) - Soft Cover - Ruled Notebooks

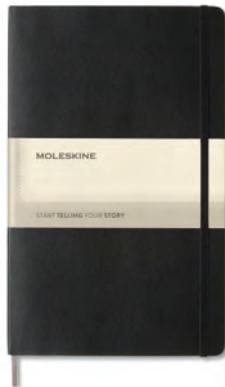

OWMOL 310



Medium (11.5 × 18 cm) - Hard Cover - Ruled Notebooks

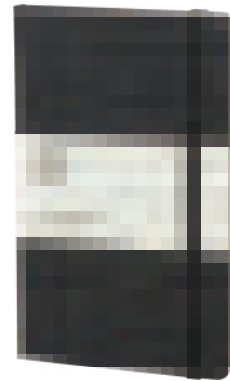

OWMOL 371

Packing Details : 41 X 27 X 22 cm ; 24pcs / carton ; gw / nw : 12.5 kg / carton

Packing Details : 41 X 27 X 22 cm ; 48pcs / carton ; gw / nw : 12.2 kg / carton

Pocket (9 × 14 cm) - Hard Cover - Ruled Notebooks



OWMOL 301 - Black



OWMOL 302 - Navy Blue

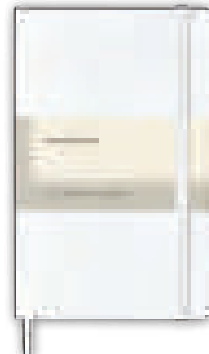

OWMOL 303 - White

Packing Details : 44 X 34 X 16 cm ; 72pcs / carton ; gw / nw : 11.5 kg / carton

Packing Details : 44 X 34 X 16 cm ; 48pcs / carton ; gw / nw : 7.7 kg / carton





**Daily Diary 2022 Available In Hard Cover & Soft Cover**

- > Rounded Corners ; Elastic Closure
- > Ivory-colored, 70 G/m<sup>2</sup>, Acid-free Paper
- > Useful Tools: Travel Planning, Time Zones, International Measurements And Dialling Codes
- > Worldwide Holidays Calendar Available
- > Moleskine.com / diaryaddons
- > Color-Coordinated Expandable Inner Pocket
- > 'In Case Of Loss' Notice Printed On The Flyleaf ; Matching Ribbon Bookmark
- > Reusable Paperband Backside Featuring Additional Printed Tools
- > Lies Flat, Opens At 180°

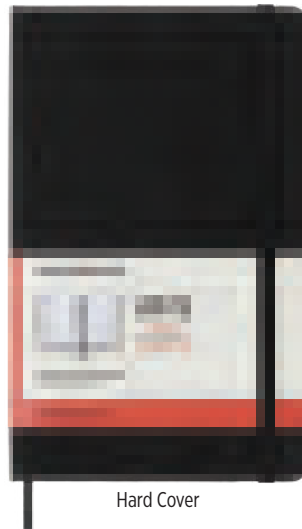

Hard Cover



Soft Cover

Calendar Planner



Time zone page



Expandable Pocket, Moleskine History, Stickers with thematic icons

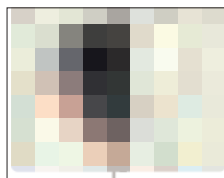

READY STOCK

OWMOL 480 - MOLESKINE 2022 DAILY PLANNER HARD COVER

OWMOL 481 - MOLESKINE 2022 DAILY PLANNER SOFT COVER

Plan out every day in the minutest detail with the 12-Month Daily Diary/Planner. Dated from January to December 2022, this planner is formatted to show one whole page per day – so you have plenty of space to record events, appointments, to-dos, reminders and plans. Throughout the year, it grows into a day-by-day physical record of everything you've accomplished.

Product Size : (Hard Cover) 13 x 21 x 2.5 cm (Soft Cover) 13 x 21 x 2.1 cm

Packing Details : 47 x 28 x 31 cm ; 36 pcs /carton ; gw/nw: 20.1 kg / carton

**Weekly Diary 2022 Available in Soft Cover**

- > Rounded Corners ; Elastic Closure
- > Useful Tools: Travel Planning, Time Zones, International Measurements And Dialling Codes
- > 'In Case Of Loss' Notice Printed On The Flyleaf ; Matching Ribbon Bookmark
- > Lies Flat, Opens At 180°

Calendar Planner

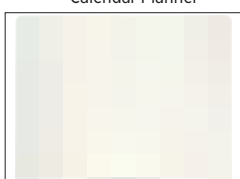

Time zone page



Expandable Pocket, Moleskine History, Stickers with thematic icons

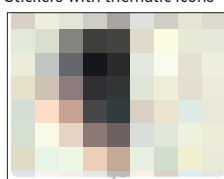

Soft Cover

OWMOL 483 - MOLESKINE 2022 WEEKLY PLANNER SOFT COVER

With the 12-Month Weekly Diary/Planner. Dated from January to December 2022, this planner is formatted to show week planning-at-a-glance

Product Size : 13 x 21 x 1.2 cm

Packing Details : 24 x 25 x 30 cm ; 36 pcs /carton ; gw/nw: 8.5 kg / carton



# ID TOOL BELT AND NOTEBOOK SET

**MOLESKINE**

READY STOCK

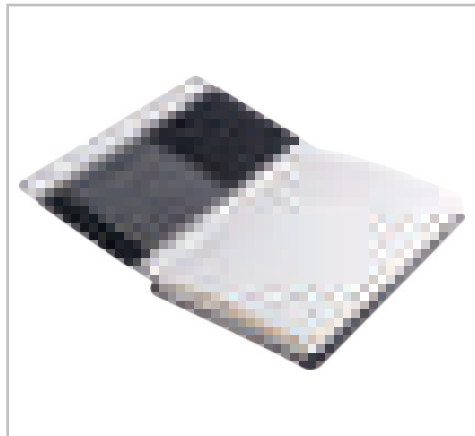

### OWMOL 151

MOLESKINE This moleskine set is a two boxed collection featuring the classic ruled large notebook & the tool belt. This Tool Belt is a neat add-on to upgrade your notebook and keep all your note-taking essentials right where you need them. The notebook measures 15 x 21 cm & has 192 pages.

Print Technique : SC, HT Preferred Print Location : Front Max Print Size : 40 x 40 mm Product size : 16.2 x 1.9 x 26.7cm



Black



Blue



White

Moleskine  
Go Pen

READY STOCK

**A PERFECT MATCH: NEVER LOSE YOUR IDEAS WITH THESE TWO TOOLS, COMPLEMENTARY IN FORM AND FUNCTION**



MOLESKINE CLASSIC LARGE NOTEBOOK & GO PEN SET

OWMOL 325 - Black OWMOL 326 - White OWMOL 327 - Blue

MOLESKINE The Moleskine Notebook and Pen Pack is a set of 2 boxed collection featuring the Classic Ruled Large Notebook with a black hardcover, and the Moleskine Go pen in black. The notebook measures 15 x 21 cm and has 192 pages whilst the pen features black ink, a 0.5 mm tip and a clip designed to attach to the notebook. Both come in a set box with lid.

Product Box Size : 19.5 x 22.5 x 2.5 cm

Packing Details : 41 X 32 X 25.5 cm ; 25 pcs / carton ; gw / nw : 11.75 kg / carton



## Contemporary Technology



READY STOCK

Scan Below QR code to watch product video



- Scalable Efficiency
- Draw / Write in Notebook
- Edit on Tablet / Mobile Phone
- E-mail Share with Colleagues /Friends
- Save as long as you like
- Access notes from anywhere
- Inbuilt Voice Recorder



### OWMOL 101 - ELLIPSE SMART WRITING SET

The Smart Writing Set Ellipse is an instant-access kit containing the Pen+ Ellipse smart pen and a Large Ruled Paper Tablet with special Ncoded paper. Simply write on the pages of the Paper Tablet with the Pen+ Ellipse for instantly-digitized notes that can be edited, transcribed, organized and shared on your device of choice. The Pen+ Ellipse clips to the cover of the Paper Tablet, so you are always ready to jot down key points in a meeting, project brainstorming ideas, to-do lists, and whatever else fill the pages of your notebook. The Smart Writing Set Ellipse makes an instant and workable digital copy of every page bringing all the advantages of borderless digital creativity to your freehand notes, sketches, diagrams and doodles.

Product size : 26 x 26 x 3 cm



CREATIVE

VALUE

A5



- > A5 Hard Cover Notebook
- > Taiwan - Made Sandisk 16GB USB Flash Drive
- > Ruled 160 Pages Each 70 gsm
- > Elastic Closure

READY STOCK

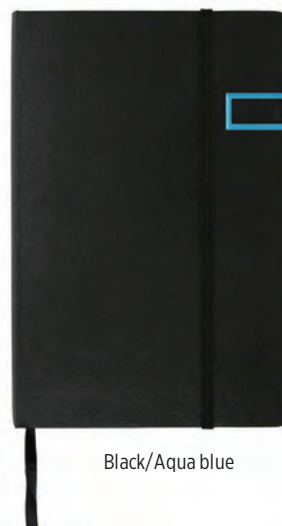

Black/Aqua blue

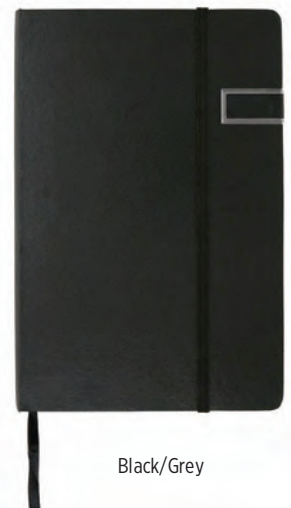

Black/Grey

- > Refillable A5 Notebook
- > 5W Wireless Charger Built in to the Nootebook
- > 160 Pages ; 70 gsm



**NBSN 905 – PESSAC**

SANTH.OME Pessac is a unique A5 refillable notebook with 5 Watt wireless charger. Made from premium interwoven fabric for smooth touch. Notebook consists of 80 sheets/160 pages each of 70 gsm. Input: 5V/1A; Wireless output: 5W.

Print Technique : SC, HT Preferred Print Location : Front  
 Max Print Size : 115 x 180 mm Product Size : 21 x 13.5 x 1.4 cm  
 Packing Details : 42 X 33 X 25 cm; 40 pcs/carton; gw/nw: 14 kg/carton

**SENTA**

**NBGL 211 - Black/Grey NBGL 212 - Black/Aqua blue**

Giftology Senta is an A5 notebook with 16GB Original Taiwan made Sandisk USB flashdrive. The notebook consists of 160 pages each 70 gsm.

Print Technique : UV, SC Preferred Print Location : Front  
 Max Print Size : 140 x 205 mm Product Size : 13 x 21 x 1.4cm  
 Packing Details : 44 x 41 x 16 cm; 50 pcs/carton; gw/nw; 13.9 kg/carton



Navy Blue



Black

READY STOCK

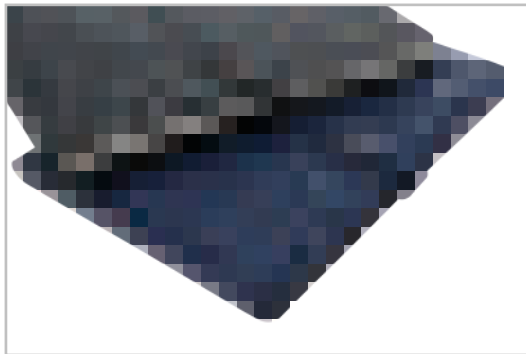

VIZELA

NBSN 204 - Black NBSN 205 - Navy Blue

SANTHOME CHAIRMAN Life is about a desire for something to happen. It is about aspirations, goals and dreams. They can be very simple but incredibly meaningful and fulfilling. The Santhome Chairman notebook inside a leather refillable journal cover accompanies you in the pursuit of your life's desires. Take notes during meetings, write down your thoughts, start a novel or try a new art medium, you can do anything!! It also comes with a pocket inside to carry your essentials.

Print Technique : SC, UV, ENG, EMB

Preferred Print Location : Front

Max Print Size : 120 x 60mm

Product size : 16.3 x 21.5 x 1.3 cm

Packing Details : 38.5 X 25 X 44 cm ; 30 pcs / carton ; gw / nw : 14.3/15.3 kg / carton



- > Cover made from recycled plastic (rPET) & treated with silver-ion Anti-Bacterial Technology
- > FSC Certified Paper
- > A5 Ruled Notebook, 160 Pages

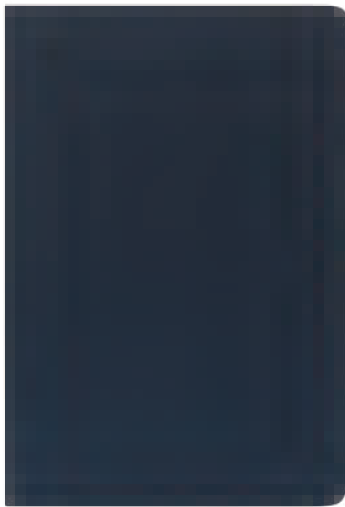

Navy Blue



Black



Grey

READY STOCK

BOOKMARK



**This Notebook Cares for You**  
Functional & Safe notebook that protects you against harmful microbes that may adhere to its surface. Kills 99.9% bacteria using Silver-Ion Technology.

**This Notebook Loves Trees**  
Paper used to make this notebook is FSC certified. FSC® certified paper is paper that has been harvested in a socially and environmentally responsible manner. By using a FSC certified paper, you are helping to ensure our forests are alive for generations to come.

**This Notebook Cares for the Environment**  
The fabric cover of the notebook is made using recycled post-consumer plastic. The rPET material itself is sourced from a Global Recycled Standard (GRS) certified factory. GRS certificate communicates truth in materials and support for a circular economy that reduces waste by using it to make new products.

A notebook that is proudly made and a notebook you would proudly use!



ORSHA

NBSN 341 - Black    NBSN 342 - Grey    NBSN 343 - Navy Blue

**SANTHOME PROTECT** A notebook that cares for you and for the environment. The cover of the notebook is made from recycled plastic (rPET) in a GRS Certified factory that complies with global recycling standards and is treated with anti-bacterial technology to provide protection against the growth of harmful bacteria. The paper used in this notebook is acid-free and FSC Certified. A5 notebook with 160 ruled pages each of 70 gsm.

Print Technique : SC, HT

Preferred Print Location : Front

Max Print Size : 120 X 200 mm

Product Size : 14 X 21 X 1.4 cm

Packing Details : ( Black ) 36.5 X 33 X 24 cm ; (Black = 50 pcs) / carton ; (Grey& navy Blue = 59 pcs / carton gw / nw : 13.3 kg / carton



# NOTEBOOKS

## SANTHOME

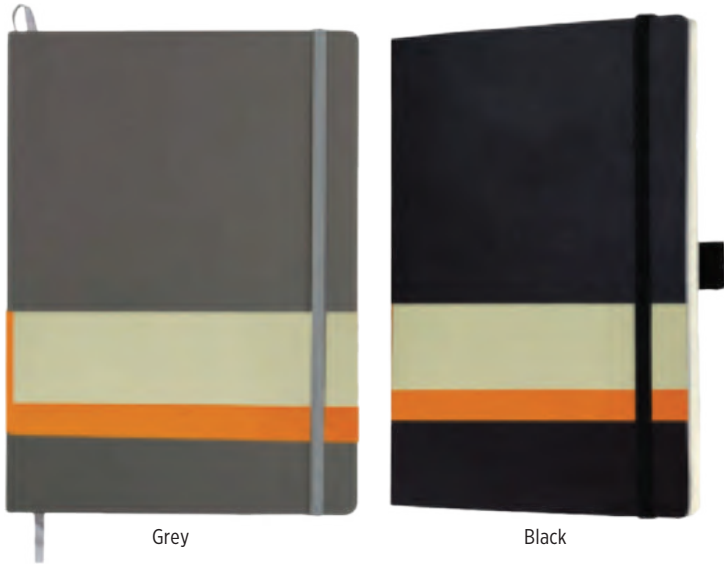

Grey

Black

Expandable Inner Pocket

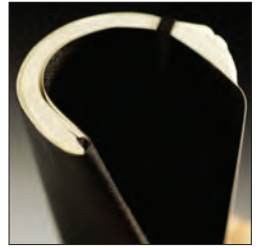
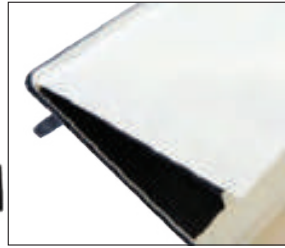

**QUALITY**

A5

- > A5 Ruled Notebook
- > Soft Cover
- > Expandable Pocket

PLABUK

NBSN 114 - Black NBSN 115 - Grey

SANTHOME Plabuk Softcover A5 PVC notebook with matching coloured 3mm elastic closure, 192 plain pages, 70gsm. Every notebook is thread bound and comes with rounded corners, a bookmark, a penloop, an elastic closure and an expandable inner pocket.

Print Technique : UV, SC, EMB Preferred Print Location : Bottom Center Max Print Size : 140 x 205 mm Product Size : 14.80 x 21 x 1.2 cm

Packing Details : 43.5 x 28 x 20.5 cm ; 60 pcs /carton ; gw/nw: 13.8 kg / carton

READY STOCK



- > A5 Hard Cover Notebook
- > Ruled Pages
- > Elastic Closure

**VALUE**

A5



White



Red



Ruled Pages



Black

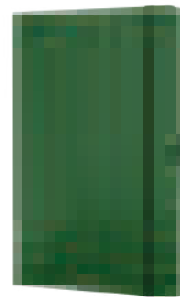

Green

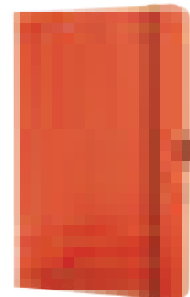

Orange

PINGER

NBGL 203 - Black NBGL 205- White NBGL 206- Red NBGL 207- Green NBGL 208- Orange

Giftology Pinger is an A5 size Hard cover Notebook with 160 ruled pages, 70 gsm. It has a matching color satin bookmark, pen loop on the side & an elastic closure which keeps your notebook tightly closed wherever you go.

Print Technique : UV, SC

Preferred Print Location : Bottom Center

Max Print Size : 140 x 205 mm

Product Size : 13 x 21 x 1.4 cm

Packing Details : 44 x 39 x 15 cm; 50 pcs/carton; gw/nw; 11.5 kg/carton



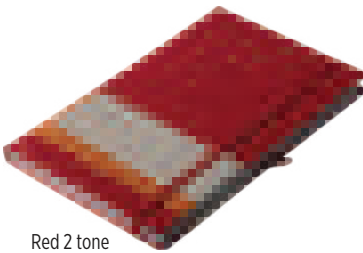
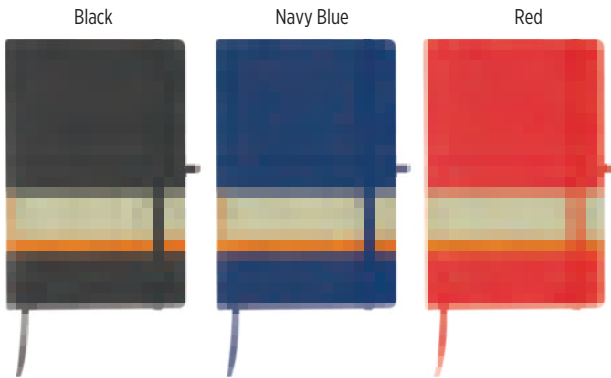

- > A5 Notebook; Ruled Pages
- > Elastic Closure ; Pen Holder Expandable Pocket
- > 192 Pages, 70g Ivory White Paper

Ruled Pages



Expandable Inner Pocket



BUKH

NBSN 101 - Black NBSN 102 - Navy Blue NBSN 103 - Red NBSN 104 - White  
NBSN 116 - Red 2 Tone

**SANTHOME** Bukh Hardcover A5 PVC notebook with matching coloured 3mm elastic closure, 192 ruled pages, 70gsm. Every notebook is thread bound and comes with rounded corners, a bookmark, a penloop, an elastic closure and an expandable inner pocket. Packed in a gift box.

Print Technique : UV, SC, EMB Preferred Print Location : Bottom Center  
Max Print Size : 140 x 205 mm Product Size : 14.8 x 21 x 1.4 cm  
Packing Details : 43.5 x 28.5 x 25.5 cm ; 60pcs/carton ; gw/nw: 17.5 kg / carton



Black-Orange

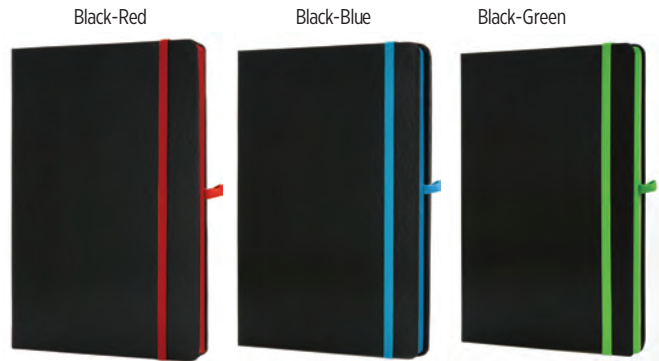

- > A5 Notebook; Ruled Pages
- > Edge-inked pages for color co-ordinated consistency
- > Elastic Closure ; Pen Holder, Expandable Pocket
- > 192 Pages, 70g Ivory White Paper

Ruled Pages

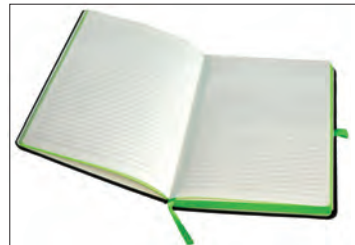

Expandable Inner Pocket

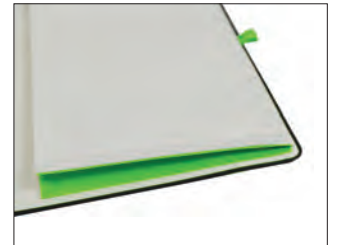

SUKH

NBSN 105 - Black-Blue NBSN 106 - Black-Red  
NBSN 107 - Black-Orange NBSN 108 - Black-Green

**SANTHOME** Sukh Hardcover A5 PVC notebook with contrast colour sides and elastic band, 192 ruled pages, 70gsm. Every notebook is thread bound and comes with rounded corners, a bookmark, a penloop, an elastic closure and an expandable inner pocket. Packed in a gift box.

Print Technique : UV, SC, EMB Preferred Print Location : Bottom Center  
Max Print Size : 140 x 205 mm Product Size : 14.8 x 21 x 1.4 cm  
Packing Details : 43.5 x 28.5 x 25.5 cm ; 60 pcs /carton ; gw/nw: 17.5 kg / carton

READY STOCK



# CREATIVE NOTEBOOKS & NOTEPADS



Black Marble

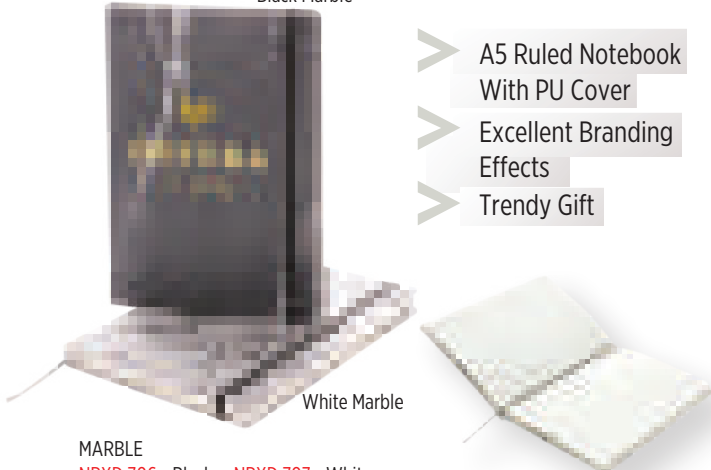

White Marble

- > A5 Ruled Notebook With PU Cover
- > Excellent Branding Effects
- > Trendy Gift

## MARBLE

NBXD 706 - Black NBXD 707 - White

XD Ruled A5 hardcover PU deluxe notebook in marble style with elastic closure and bookmark ribbon. 192 pages (96 sheets) of 80g/m<sup>2</sup> inside. Cream coloured pages.

Print Technique : UV, SC, ENG, EMB Preferred Print Location : Front

Max Print Size : 100 x 150 mm Product Size : 20.0 x 14.0 x 1.5 cm

Packing Details : 19.5 X 22.5 X 32 cm ; 24 pcs / carton ; gw / nw : 7.58 kg / carton



A5

Gold

Bronze

Silver



## SURAKARTA

NBMK 101 - Silver NBMK 102 - Gold NBMK 103 - Bronze

PU leather notepad in eye catching metallic colors. Available in golden, silver and bronze colors. With hard covers, elastic band and matching color fabric bookmark. Including 80 plain sheets in ivory color.

Print Technique : SC, UV, EMB

Preferred Print Location : Bottom Center

Max Print Size : 100 x 160 mm

Product Size : 14.7 x 21 x 1.5 cm

Packing Details : 37.5 X 23.5 X 37.5 cm ; 50 pcs / carton ; gw / nw : 13.5 kg / carton



Heart



Sunglass



Wink

## ADELANTO

NBMK 104 - Heart NBMK 105 - Sunglass NBMK 106 - Wink

Notebook/Notepad of cheerful emoji designs in eye-catching yellow color. With white rings, rigid cardboard covers in soft glossy finish and 40 blank sheets..

Print Technique : SC, UV

Preferred Print Location : Back

Max Print Size : 40 x 15 mm

Product Size : 8 x 9 x 1.1 cm

Packing Details : 28 x 19 x 63.5 cm ; 500 pcs / carton ; gw / nw : 11.5 kg / carton

## MODERN FABRIC COVER



A5



## NBGL 202 - LINGER

Giftology Linger A5 Hard cover notebook with modern fabric cover. It has 160 ruled pages of 70gsm and ivory colored, a satin bookmark ribbon that does not easily fray, and the elastic closure that keeps your notebook tightly secured wherever you go.

Print Technique : SC, HT

Preferred Print Location : Bottom Center

Max Print Size : 140 x 205 mm

Product Size : 14.8 x 21 x 1.5 cm

Packing Details : 44 x 37 x 15 cm ; 50 pcs / carton ; gw / nw : 11.85 kg / carton

READY STOCK



**SANTHOMÉ**  
eco lifestyle

CREATIVE

QUALITY

Earth is a wonderful home and should be treated with respect. At the same time, the brand Santhome creates beautiful design. The Bamboo Notebook embodies both of these philosophies -- bamboo is actually a grass, that grows quickly and has the strength of a hardwood. Its bold design makes it a powerful tool that communicates your commitment to sustainability!



READY STOCK



- > 256 Pages
- > Combination Of Squared, Ruled & Blank Pages
- > Express Your Commitment To Sustainability
- > Eco-Friendly !!

Laser Engrave Your Logo & Be Part Of This Vision !

**NBSN 201 – GANDRA**

SANTHOMÉ Back to nature with this eco-friendly bamboo cover notebook with 128 sheets/256 pages in ivory color each 100 gsm. Inner pages include a combination of ruled, grid (squared) and blank pages. Natural bamboo ensures no two notebooks look the same. Packed in a eco-friendly gift box.  
 Print Technique : UV, SC, ENG Preferred Print Location : Top Max Print Size : 110 x 160 mm  
 Product Size : 18.5 x 13 x 2.2 cm Packing Details : 13 X 18.8 X 2.2 cm; 24 pcs/carton; gw/nw: 14.5 kg/carton



A5



NBEN 103 - BORSA

eco-neutral Borsa is an eco friendly notebook with 160 pages each 80 gsm and made from a combination of fabric and cork materials. Also includes a matching Eco Friendly pen made from Cork and Eco-Friendly Wheat Straw. Packed in a gift box.

Print Technique : UV,SC Preferred Print Location : Front Bottom Max Print Size : 60 x 110 mm (Book) 40 x 7mm (Pen clip)  
Box Size : 22 x 16 x 1.8 cm Packing Details : 50.8 x 35 x 25.8cm; 48 pcs/carton; gw/nw: 15.5 kg/carton

READY STOCK



A5



NBEN 102 - CORQ

eco-neutral Notebook made out of natural cork with 160 pages of 80g. With black page divider and black elastic band. Including bamboo pen with stylus tip and ballpoint. Eco-friendly set packing box.

Print Technique : UV Preferred Print Location : Book Bottom Center Max Print Size : 140 x 205 mm (Book) 25 x 6mm (Pen)  
Box Size : 21 x 25 x 1.7 cm Packing Details : 44.5 x 43 x 26.5 cm; 40 pcs/carton; gw/nw: 15 kg/carton



- > 80 Pages Ruled Notebook
- > Eco-Friendly Cover
- > A5 Size
- > Value Deal !!

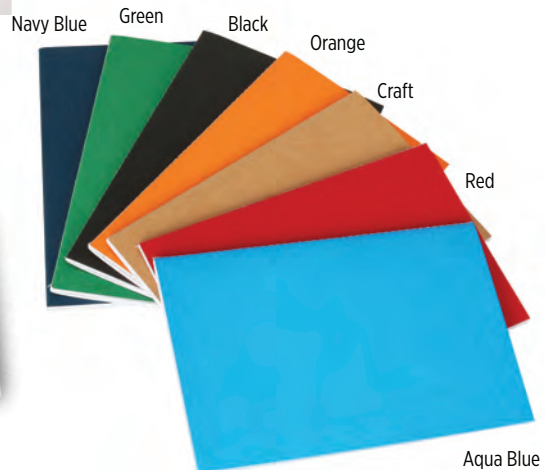

VINICA

NBGL 215-Black NBGL 216-Craft NBGL 217-Aqua Blue NBGL 218-Navy Blue NBGL 219-Red

NBGL 220-Green NBGL 221-Orange

eco-neutral Classic design notebook with cardboard covers in eye-catching colors and smooth finish. With matching color seams on side and 80 ruled pages.

Print Technique : SC, UV Preferred Print Location : Front Max Print Size : 100 x 170 mm  
Product Size : 20.5 x 14 x 0.5 cm



A5

Blue



Black

Lime

Red

White

- > A5 Hard Cover Notebook With Pen
- > 160 Pages Of 70g/m2 Inside
- > Gift Box

WAGGA

GSXD 110 - Black GSXD 111 - White GSXD 112 - Blue GSXD 113 - Red GSXD 114 - Lime

XD COLLECTION Ruled A5 hardcover standard notebook set including plastic pen. 160 pages of 70g/m2 inside. White coloured pages. Packed in Gift box.

(Notebook) Print Technique : UV, SC Preferred Print Location : Front  
 Max Print Size : 120 x 180 mm  
 (Pen) Print Technique : UV, SC Preferred Print Location : Next to clip  
 Max Print Size : 25 x 7 mm Product Box Size : 22.5 x 17.2 x 2 cm  
 Packing Details : 38 x 25 x 36 cm ; 32pc /carton; gw/nw: 10.7kg / carton



A6

Royal Blue



White

Red

Silver

- > A6 Hard Cover Notebook With Stylus Pen
- > 144 Pages Of 70g/m2 Inside
- > Gift Box

ALBURY

GSXD 122 - Silver GSXD 121 - White GSXD 124 - Red GSXD 123 - Royal Blue

XD COLLECTION Ruled A6 hardcover classic notebook set including aluminium stylus pen. With elastic closure and bookmark ribbon. 144 pages of 70g/m2 inside. Cream coloured pages. Packed in Gift box.

(Notebook) Print Technique : UV, SC Preferred Print Location : Front  
 Max Print Size : 110 x 60 mm  
 (Pen) Print Technique : UV, SC Preferred Print Location : Next to clip  
 Max Print Size : 25 x 7 mm Product Box Size : 15.7 x 12.2 x 2 cm  
 Packing Details : 46 x 19 x 30 cm ; 40pc /carton; gw/nw: 6.5 kg / carton

READY STOCK



CREATIVE  
VALUE

Pen Attaches Magnetically To The Notebook !!

READY STOCK



Black



Blue



Red



Orange

A5



> Pen Attaches To The Magnet  
On The Notebook

> 160 Pages ; 80 gsm

> Gift Box

> Value Deal !!

CAMPINA

GSGL 301 - Black GSGL 303 - Blue GSGL 305 - Red GSGL 306 - Orange

Giftology Campina is an A5 notebook with magnet inside the cover to attract the included matching twist action metal pen. The notebook consists of 80 sheets/160 pages of 80 gsm. Packed in a gift box.

(Notebook) Print Technique : UV, SC

Preferred Print Location : Front

Max Print Size : 90 x 180 mm

(Pen) Print Technique : UV, SC

Preferred Print Location : Next to clip

Max Print Size : 30 x 7 mm

Product Box Size: 15.5 x 21.8 x 1.7cm

Packing Details: 38 x 35 x 35.5 cm; 50 pcs /carton; gw/nw: 5.5 kg /carton



- > PU Notebook Cover
- > 160 Ruled Pages, Rounded Corners
- > 1300 Meters Writing Length For Pen
- > Gift Box



Black



Red



Orange



Pink

READY STOCK



Royal Blue



Slate Grey



Green



Aqua

A5

**LIBELLET**

GSGL 201 - Black GSGL 202 - Royal Blue GSGL 203 - Red GSGL 204 - Orange GSGL 205 - Slate Grey GSGL 206 - Aqua  
GSGL 207 - Green GSGL 208 - Pink

Giftology Libellet is a notebook and pen set consisting of a hard cover PU notebook with a matching color pen with geometric design. The round cornered notebook consists of 160 ruled pages, 70 gsm with matching colored 3mm elastic closure, a bookmark and a pen loop. Packed in a gift box.

(Notebook) Print Technique : UV, SC, EMB Preferred Print Location : Front Max Print Size: 210 x 140 mm

(Pen) Print Technique : UV, SC Preferred Print Location : Clip Max Print Size: 8 x 37 mm

Product Box Size : 22.5 x 19.5 x 2 cm

Packing Details: ; 30 x 25 x 40 cm ; 32 pcs /carton ; gw/nw: 12.50 kg / carton



# ECO GIFT SET

## Useful eco-conscious gift set with sustainable packaging:

**Notebook** - Kraft cover with FSC-certified paper inside

**Mug** - Wheatstraw material with silicone sleeve

**Pen** - Made with wheatstraw material

**VALUE**

READY STOCK



Wheatstraw Mug w/ silicone



Notebook with FSC paper



Wheatstraw Pen

- > All products plus packaging from sustainable materials
- > Silicone sleeve helps hold mug with hot liquid
- > 80 pgs Notebook - 14 x 9 cm, 70 gsm
- > Give VALUE, Save Ecology when you give out this set
- > 380 ml Mug capacity



GSEN 681 - KORGAN

(Notebook) Print Technique : SC, UV

(Pen) Print Technique : SC, UV

(Mug) Print Technique : SC

Box Size: 14.5 x 10.3 x 9.7 cm; Each set of 3 in box weighs 176 gms

Preferred Print Location : Front

Preferred Print Location : Clip

Preferred Print Location : Front

Max Print Size : 70 x 130 mm

Max Print Size : 7 x 35 mm

Max Print Size : 30 x 50 mm



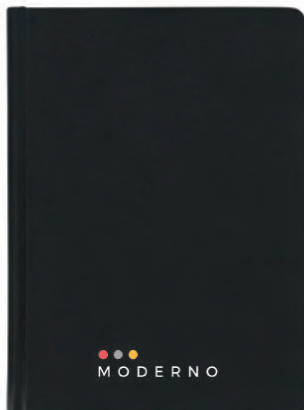

- SS Water Bottle with easy Grip & Flat Sides
- Bottle, Notebook & Pen Set In Gift Box
- Pen With German Dokumental® Ink
- 216 Pages Notebook With Legendary Flair



### GSSN 101 - ARGAKI

SANTHOME Gift set consisting of a double wall water bottle, pen and notebook. The water bottle keeps liquids cold for up to 12 hours and hot for 8 hours without any sweating on the exterior. Notebook is a retro piece of art that gels perfectly with the hexagonal body pen having German Dokumental® ink. A perfect gift that communicates modern flair.

(Notebook) Print Technique : SC, FO, UV, EMB

(Pen) Print Technique : SC, UV, ENG

(Bottle) Print Technique : UV, SC, ENG

Product Box Size : 28 X 25.5 X 9 cm

Preferred Print Location : Front

Preferred Print Location : Barrel

Preferred Print Location : Front

Packing Details : 66.5 X 55.5X 29 cm ; 16 pcs / carton ; gw / nw : 16.3 kg / carton

Max Print Size : 160 x 100 mm

Max Print Size : 25 x 6 mm

Max Print Size : 30 x 120 mm

READY STOCK



- 216 Ruled Pages
- Notebook & Pen Set In Gift Box
- Pen With German Dokumental® Ink
- Modern Notebook With Legendary Flair

### TOMAR

#### GSSN 403-Black

SANTHOME Heritage notebook that bring stylish neo-retro patterns to life with an urban and legendary flair. Tomar consists of 106 sheets/ 216 ruled pages each of 100 gsm. Also includes a stylish metal pen with 1200 meter writing German Dokumental® Ink.

(Notebook) Print Technique : SC, FO, UV, EMB

(Pen) Print Technique : SC, UV, ENG

Product Box Size : 19.6 X 18 X 2.5 cm

Preferred Print Location : Front

Preferred Print Location : Barrel

Packing Details : 37.5 X 21 X 40 cm ; 30 pcs / carton ; gw / nw : 15.4 kg / carton

Max Print Size : 160 x 100 mm

Max Print Size : 25 x 6 mm



- > A5 Refillable Notebook Cover, Notebook Included
- > Pen Included
- > Pocket On Cover To Hold Pen, Cash, Phone etc.



**NBSW 708 - TACCUINO**

**SWISS PEAK**® Executive 1680D and 600D polyester notebook cover with a trendy Swiss Peak pen. Including removable notebook with 160 pages of 80g/m2 inside. Pocket on the cover can hold pen, cards, cash cell phone etc. Packed in Swiss Peak giftbox.

Print Technique : HT, SC Preferred Print Location (Sleeve): Front  
Max Print Size : 70 x 110 mm  
Print Technique : ENG, SC Preferred Print Location (Pen) : Barrel  
Max Print Size : 6 x 45 mm Product Size : 23.3 x 16.7 x 2.0 cm  
Packing Details : 50.1 X 28 X 45.5 cm ; 30 pcs / carton ; gw / nw : 17.6kg / carton

**SANTHOME**



- > A5 Refillable Notebook Cover, Notebook Included
- > Pen Included
- > Pockets Inside To Hold Cards, Documents, Pens Etc.



**GSSN 402 - KUTINA**

**SANTHOME** Set consisting of smart notebook cover made from executive 1680D polyester and twist action metal ballpoint pen. Including refillable notebook with 160 pages of 80g/m2 inside. Pockets on the inside to hold documents and cards. Packed in a giftbox.

Print Technique : EMB, ENG, SC, HT Preferred Print Location : Front  
Product Size : 22.5 X 18 X 3 cm Max Print Size : 65x 65 mm  
Packing Details : 54.5 X 46 X 28 cm ; 20 pcs / carton ; gw / nw : 15.8 kg / carton

READY STOCK



  
Pierre Cardin  
PARIS



Legendary French designer, fashion designer and innovator Pierre Cardin. As a graduated architect he started his career of fashion designer after the Second World War under the guidance of a renowned master in the field, Mr Christian Dior.

In 1950 he sets up his own fashion saloon and in 1953 he becomes a member of the prestigious French association Chambre Syndicale de la Haute Couture. In 1959 he starts a revolution in the field by creating a first collection in history directly produced for the sale and wearing "prêt-à porter". In this way he brings high fashion to the general public.

Besides textiles and accessories Pierre Cardin designs furniture, interiors, objects of applied arts & has also worked for automobile and aircraft industry and in other areas.

Since 1991 Pierre Cardin has held the position of honorary ambassador of UNESCO and since 2009 he has been a good will envoy of the FAO of the United Nations.

Pierre Cardin has received a number of awards and decorations of high degree from institutions all over the world. Since 1977 he has several times been given De d' Or" (golden thimble), the largest honor of French haute culture. Pierre Cardin was the first fashion designer in history to win, in 1992, a chair in the French Academy of Fine Arts ( Academie des Beaux-Arts ).

The collection of original Pierre Cardin products has been carefully produced from selected materials and created with the emphasis on detail and attractive design.

History shows that Pierre Cardin is not only a fashion trademark, he is also a symbol of timelessness.



WIPC 710



WIPC 746

FEATURES :

- > Endless usage, refillable notebook sleeve with modern PIERRE CARDIN pen and notebook
- > 160 ruled pages; ivory color
- > Back pocket to keep phone & cards
- > PIERRE CARDIN bookmark

Packaging

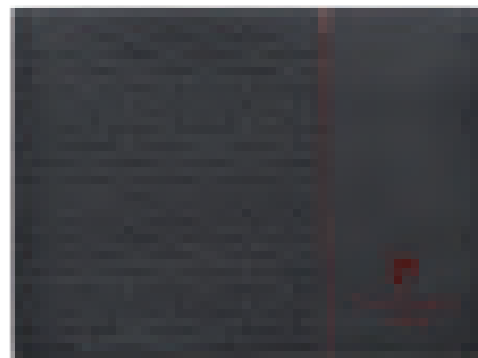

READY STOCK

WIPC 710 - JURA

(Notebook) Print Technique : UV, SC Preferred Print Location : Front  
 Max Print Size : 50 x 170 mm  
 (Pen) Print Technique : UV, SC, ENG Preferred Print Location : Barrel  
 Max Print Size : 30 x 8 mm Product size : 19 x 14 x 1.3 cm  
 Packing Details : 43 X 43 X 51 cm ; 40 pcs / carton ; gw / nw : 16kg / carton

WIPC 746 - NORDEN

(Notebook) Print Technique : UV, SC Preferred Print Location : Front  
 Max Print Size : 50 x 170 mm  
 (Pen) Print Technique : UV, SC, ENG Preferred Print Location : Barrel  
 Max Print Size : 30 x 8mm Product size : 19 x 14 x 1.3cm  
 Packing Details : 43 X 43 X 51 cm ; 40 pcs / carton ; gw / nw : 16kg / carton

FEATURES :

- > PIERRE CARDIN pocket jotter
- > Premium refillable PU cover
- > With silver PIERRE CARDIN logo
- > Contrast white stitching
- > Pen included



NPPC 781 - WIEN

(Notebook) Print Technique : UV, SC Preferred Print Location : Front & Inner Max Print Size : (Front) 55 x 50mm (Inner) 85 X 35 mm  
 (Pen) Print Technique : UV, SC, ENG Preferred Print Location : Next to Clip Max Print Size : 5 x 25mm  
 Product size : 8 x 13 x 1.5cm Packing Details : 57 X 36 X 36 cm ; 65 pcs / carton ; gw / nw : 11.9kg / carton



**FEATURES :**

- Modern fabric cover
- See-through phone pocket
- With modern PIERRE CARDIN pen
- Pockets to keep cards
- Phone/tablet stand
- PIERRE CARDIN ruled notepad included

**PNPC 703 - AVIGNON**

( Folder) Print Technique : SC, ENG Preferred Print Location : Plate Max Print Size : ( ENG 30 x 15mm) ( SC 50 x 30mm)

( Pen) Print Technique : UV, SC, ENG Preferred Print Location : Barrel Max Print Size : 30 x 6 mm

Packing Details : 56.5 X 26.5 X 33cm ; 25 pcs / carton ; gw / nw : 15.3 kg / carton

**READY STOCK**

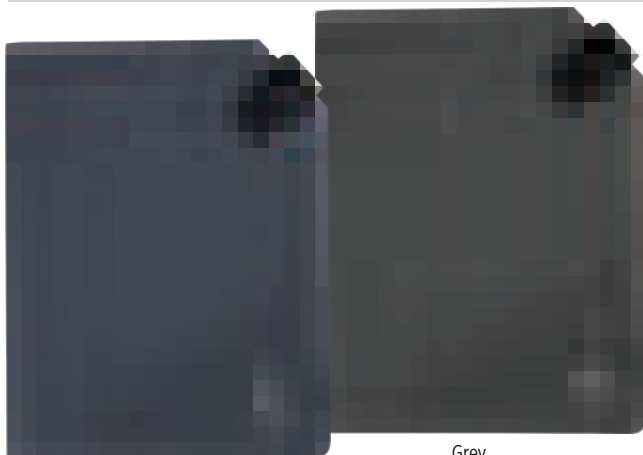

Blue

Grey

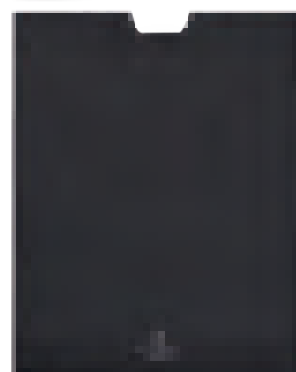

**FEATURES :**

- Modern fabric cover
- See-through phone pocket
- with modern PIERRE CARDIN pen
- Pockets to keep cards
- Phone/tablet stand
- PIERRE CARDIN ruled notepad included



**SARTHE**

**PNPC 702 - Blue PNPC 701- Grey**

( Folder) Print Technique : SC, ENG Preferred Print Location : Plate Max Print Size : 50 x 30 mm

( Pen) Print Technique : UV, SC, ENG Preferred Print Location : Barrel Max Print Size : 30 x 6 mm

Product Size : 19 x 14 x 1.3 cm Packing Details : 59 X 28 X 35cm ; 25 pcs / carton ; gw / nw : 18 kg / carton

For consumption in selected East & West African countries



WIPC 740      WIPC 741  
PROVENCE SET



PBPC 101

FEATURES :

- > Ballpoint and roller pen set
- > Black laquard with rose gold trims
- > Blue refill with 0.5mm nib
- > Reveals executive class

(Pen) Print Technique : UV, SC, ENG  
 Preferred Print Location : Barrel  
 Max Print Size : 30 x 8mm  
 Preferred Print Location : Front  
 (Box) Print Technique : UV, SC  
 Max Print Size : 60 x 40mm  
 Packing Details : 39.8 X 37.5 X 20.2 cm; 50 pcs/  
 carton; gw/nw: 10.7 kg/carton



WIPC 706  
MONACO



PBPC 101

FEATURES :

- > Twist action ballpoint pen
- > Black laquard with rose gold trims
- > Blue refill with 0.5mm nib
- > Stainless steel body

(Pen) Print Technique : UV, SC, ENG  
 Preferred Print Location : Barrel  
 Max Print Size : 30 x 8mm  
 Preferred Print Location : Front  
 (Box) Print Technique : UV, SC  
 Max Print Size : 60 x 40mm  
 Packing Details : 39.8 X 37.5 X 20.2 cm; 50 pcs/  
 carton; gw/nw: 9.6 kg/carton

READY STOCK



WIPC 714 WIPC 715  
PANTHEON

(Box) Print Technique : UV, SC Preferred Print Location : Front Max Print Size : 60 x 40mm  
Packing Details : 40 X 37.5 X 20cm; 50 pcs/carton; gw/nw: 11.2 kg/carton

**FEATURES :**

- Ballpoint pen and fountain pen set
- 2000 metres running length
- Silver cover with distinctive latin engraving
- Blue refill with 0.5mm tip
- Peerless clip mechanism
- A connoisseur's collectable

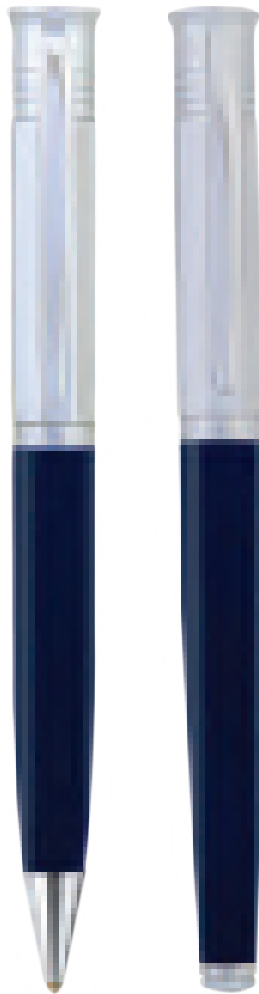

WIPC 716 WIPC 717  
ANNECY



PBPC 101

**FEATURES :**

- Ballpoint and roller pen set
- 2000 metres running length
- Geometric top
- Blue refill with 0.5mm tip
- Ballpoint pen with peerless mechanism
- Dignified pen set that suits your style

(Pen) Print Technique : UV, SC, ENG Preferred Print Location : Barrel Max Print Size : 30 x 8mm  
(Box) Print Technique : UV, SC Preferred Print Location : Front Max Print Size : 60 x 40mm  
Packing Details : 40 X 37.5 X 20cm; 50 pcs/carton; gw/nw: 12.2 kg/carton

READY STOCK



WIPC 701



WIPC 702



WIPC 703



WIPC 704

LYON

CANNES



PBPC 101

READY STOCK

FEATURES :

- > Metal ballpoint pen
- > Chequered aluminium barrel
- > Blue refill with 0.5mm nib
- > Matt finish barrel and smooth finish clip area

FEATURES :

- > Twist action ballpoint pen
- > Chrome finish trims in gun metal color
- > Blue refill with 0.5mm nib
- > Rich smart design

(Pen) Print Technique : UV, SC, ENG Preferred Print Location : Barrel  
 Max Print Size : 30 x 8mm  
 (Box) Print Technique : UV, SC Preferred Print Location : Front  
 Max Print Size : 60 x 40mm  
 Packing Details : 40 X 37.5 X 20cm; 50 pcs/carton; gw/nw: 9 kg/carton

(Pen) Print Technique : UV, SC, ENG Preferred Print Location : Barrel  
 Max Print Size : 30 x 8mm  
 (Box) Print Technique : UV, SC Preferred Print Location : Front  
 Max Print Size : 60 x 40mm  
 Packing Details : 40 X 37.5 X 20cm; 50 pcs/carton; gw/nw: 9.2 kg/carton





**FEATURES :**

- > Smooth metal surface pen
- > Clip with rubberised finish
- > Blue roller pen refill with 0.5mm nib
- > Comes with spare roller refill
- > Geometric clip design



**WIPC 711**  
BRITTANY

(Pen) Print Technique : UV, SC, ENG Preferred Print Location : Barrel Max Print Size : 30 x 7mm  
(Box) Print Technique : UV, SC Preferred Print Location : Front Max Print Size : 60 x 40mm  
Packing Details : 39.8 X 37.5 X 20.2 cm; 50 pcs/carton; gw/nw: 9.5 kg/carton

**PBPC 101**



**WIPC 743 - ARIES**

Print Technique: UV, SC Preferred Print Location: Barrel  
Max Print Size: 30 x 5mm  
Packing Details : 48 X 45 X 31cm; 500 pcs/carton; gw/nw: 14.5 kg/carton

READY STOCK



**FEATURES :**

- > Clip action ballpoint metal pen
- > Blue refill with 0.5mm nib
- > Clip with spring action
- > Simple and elegant

**WIPC 705**  
MARSEILLE

(Pen) Print Technique : UV, SC, ENG Preferred Print Location : Barrel  
Max Print Size : 30 x 6mm  
Packing Details : 34 X 28 X 19cm; 400 pcs/carton; gw/nw: 14 kg/carton



**FEATURES :**

- > Clip action ballpoint pen
- > Silver aluminium body
- > Blue ballpoint refill with 0.5mm nib
- > Fine PIERRE CARDIN engraving on surface
- > Slim and light weight

**WIPC 745**  
MENTON

(Pen) Print Technique : UV, SC, ENG Preferred Print Location : Barrel  
Max Print Size : 30 x 4mm  
Packing Details : 48 X 45 X 31cm; 500 pcs/carton; gw/nw: 12.8 kg/carton



**PBPC 103**



Built to slide into your Moleskine Notebook





Classic Ballpoint pens



Black White Royal Blue

Classic Roller pens



Black White

- > Pens "Made In Italy"
- > Moleskine Ballpoint and Roller Pen Series
- > Clip The Moleskine Pen To Your Moleskine Notebook
- > Brushed Steel Clip

OWMOL 353 - BLACK OWMOL 354 - WHITE OWMOL 358 - ROYAL BLUE OWMOL 351 - BLACK OWMOL 352 - WHITE  
 The perfect match for the Moleskine notebook, Moleskine pens are designed specifically to clip onto the side of the classic hard cover.  
 Product Size : 14.5 x 1.5 x 1.3 cm Packing Details : 40.2 x 12.4 x 18.8 cm ; 36 pcs /carton ; gw/nw: 1.25 kg / carton

READY STOCK

Go Pens



Prussian Blue White Black

- > Pens "Made In Italy"
- > Clip The Moleskine Pen To Your Moleskine Notebook

OWMOL 357 - PRUSSIAN BLUE OWMOL 356 - WHITE OWMOL 355 - BLACK  
 The perfect match for the Moleskine notebook, Moleskine pens are designed specifically to clip onto the side of the classic hard cover.  
 Product Size : 14.5 x 1.5 x 1.3 cm Packing Details : 40.2 x 12.4 x 18.8 cm ; 36 pcs /carton ; gw/nw: 1.25 kg / carton

# ottohutt

GERMANY 1920

Otto Hutt stands for high-quality writing devices that set new standards regarding individuality and precision. Clear shapes, aesthetic design, perfected functionality. Products by Otto Hutt bear a logo on the stylized nib inspired by the Bauhaus signet by Oscar Schlemmer from 1922. An unmistakable symbol of creative standards and the brand's stylistic self-conception: "Form follows function".

# ottohutt

GERMANY 1920

## Precious metals

The writing instruments' high-quality gold, platinum, or silver coating requires an extremely precise procedure and the utmost care. Situated in the German centre of precious metal and jewellery manufacturing, Otto Hutt is of course a master par excellence in these techniques.

Unique.  
By tradition.

Exclusive writing  
instruments.  
Since 1920.

Craftsmanship.  
Of Conviction.

Individualism.  
With style.

Manufacturing  
expertise.  
Made in Germany.

Unique,  
Precision,  
materials,  
features.



# ottohutt

GERMANY 1920

## Guilloché

The origins of this engraving procedure, developed in the 17th century, trace back to the classical jewellery industry. Otto Hutt is one of the few companies that still uses this sophisticated technique. Not only has Otto Hutt continued this precision process manually, but they've developed it even further, adding innovative CNC control.





 otto hutt



WIOTH 504

otto hutt Rollerball & Ballpoint pen set with barrel sterling silver smooth surface, gold - plated fittings

Print Technique : ENG Preferred Print Location : Next to clip / On Box  
 Max Print Size : 30 x6 mm Product Size : 13.5 x ø1.3 cm

READY STOCK

 otto hutt



WIOTH 516  
 WAVE PATTERN

otto hutt After applying a coat of black colored enamel, the three- dimensional guilloche pattern is added with waves that vary in depth. These are coated with white, followed by several more layers of enamel, and then sanded and polished.

Print Technique : SC Preferred Print Location : Clip / Box  
 Max Print Size : 30 x3 mm Product Size : 13.5 x ø1.3 cm





- > High Quality Ballpoint Pen
- > Sturdy Steel Exterior
- > Elegant Swiss Peak Sleeve



WISW 810 - LUZERN

**SWISS PEAK®** This ballpen is known by its quality and elegance. Comes with 1200m writing refill with German ink. Packed in Swiss Peak Sleeve.

Print Technique : ENG, SC Preferred Print Location : Next to clip  
 Max Print Size : 40 x 5 mm Product Size : 13.8 x ø1.0 cm  
 Packing Details :  
 18.0 x 34.0 x 54.0 cm ; 500pc /carton ; gw/nw: 10 kg / carton



- > High Quality Ballpoint Pen & Pencil
- > Sturdy Steel Exterior
- > Elegant Swiss Peak Gift Box



WISW 811 - LUZERN SET

**SWISS PEAK®** This pen set with ballpen and pencil is known by its quality and elegance. Comes with 1200m writing refill with German ink and pencil with 3 leads of 0.7 mm. Packed in Swiss Peak giftbox.

Print Technique : ENG, SC Preferred Print Location : Next to clip  
 Max Print Size : 130 x 100 mm Product Box Size : 2.5 x 24.5 x 32.5 cm  
 Packing Details :  
 30.0 x 39.0 x 49.0 cm ; 200pc /carton ; gw/nw: 12 kg / carton

READY STOCK

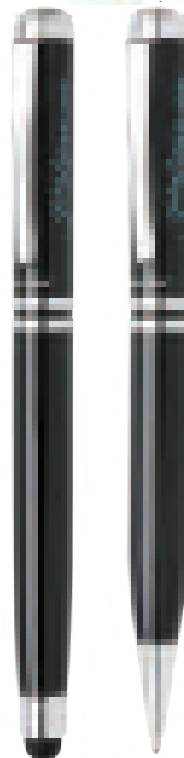

READY STOCK

**WISW 704 - RUNAPE**

**SWISS PEAK®** Unique styled pen with a luxury lined pattern on the barrel. This exclusive designed stylus ballpoint pen is an attractive, high quality gift. Including Swiss Peak tube giftbox. Blue ink.

Print Technique : SC, ENG Preferred Print Location : Barrel

Max Print Size : 47 x 5 mm Product Size : 14.0 x ø1.0 cm

Packing Details : 28 x 41 x 35 cm ; 300 pcs/carton; gw/nw: 14kg / carton

**WISW 705 - DUSCO SET**

**SWISS PEAK®** Authentic pen set bearing all the hallmarks of classic quality. High quality heavy brass metal rollerball with stylus and ball point pen with Swiss Peak branding. Including premium PU leather pouch and giftbox. Blue ink.

Print Technique : SC, ENG Preferred Print Location : Barrel

Max Print Size : 45 x 6 mm Product Size : 14.0 x ø1.1 cm

Packing Details : 53 x 39 x 36 cm; 100 pcs / carton; gw/nw: 17kg /carton



Scan Below QR code to watch product video



Grey-Blue

Grey-White



KONEKT

WIXD 509 - Grey-White WIXD 510 - Grey-Blue

XDDDESIGN® Konekt brings a metal ballpoint pen and a rollerball pen closer together by connecting the clips. Both ballpoint pen and roller pen are delivered with black & blue refills. Registered design®

Print Technique : UV, SC, ENG Preferred Print Location : Next to Clip

Max Print Size : 70 x 6 mm Product Box Size : 16.5 x 4.9 cm

Packing Details : 44 x 27.5 x 38.5 cm ; 80 pcs /carton ; gw/nw : 7 kg / carton



MP 891 - VERTO

XDDDESIGN® Verto is a set containing a ballpoint pen and a rollerball pen made from high quality brass, presented in a sliding box. The solid clip has spring function. Registered design®

Print Technique : UV, SC, ENG Preferred Print Location : Next to Clip

Max Print Size : 40 x 5 mm Packing Box Size : 14.5 x 20.5 x 2.7 cm

Packing Details : 65 x 44 x 32 cm ; 80 pcs /carton ; gw/nw : 20 kg / carton

READY STOCK

Scan Below QR code to watch product video



Clip it anywhere

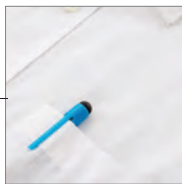

WIXD 501 - SPIN

XDDDESIGN® Spin is a metal 360° ergonomic stylus pen with 6 clips so you can attach it anywhere you want. Delivered with extra refill. Registered design®

Print Technique : UV, SC, ENG Preferred Print Location : Barrel

Max Print Size : 30 x 5 mm Product Size : 14.5 x ø1.2 cm

Packing Details : 33.5 x 27 x 37 cm ; 160 pcs /carton ; gw/nw : 7 kg / carton

USB PEN



➤ Available In 4GB

➤ Includes Touch Pen

➤ Excellent Branding Space



ITXD 815 - STYLO-4GB

XDDDESIGN® Stylo brings traditional writing and current technology together in one pen. Small notes or a quick sketch can be made with the ballpoint on paper or with the precision touch pen on your phone or tablet. On top of that all your data can be stored on the 4GB USB stick. Registered design®

Print Technique : UV, SC, ENG Preferred Print Location : Clip

Max Print Size : 25 x 8 mm Product Box Size : 21 x 4.6 x 2.6 cm

Packing Details : 0.037 cbm ; 100 pcs /carton ; gw/nw : 8 kg / carton





**XDDESIGN®**



**MP 895 - CURBA**

XDDESIGN® Curba is a stainless steel ballpoint pen where round simplicity and finish makes the design. The pen can be refilled. Registered design®

Print Technique : UV, SC, Eng Preferred Print Location : Next to Clip

Max Print Size: W=35 x H=6mm Product Size: 14 x 1.2 cms

Packing Details : 38 x 36.5 x 27 cms ; 160 pcs /carton ; gw/nw: 7 kg / carton

Black



Unique Hexagonal Body

Blue



German Dokumental® Ink

Pink



Swiss Tip

VOGAR

WIMP 208 - Black WIMP 209 - Blue WIMP 210 - Pink

Metal twist action pen. Including ca. 1200m writing length German Dokumental® blue ink refill with TC-ball for ultra smooth writing.

Print Technique : UV,SC,ENG Preferred Print Location : Barrel

Max Print Size : 65 x 8 mm Product Size: 13.8 x ø1.1 cm

Packing Details : 42X 32 X 19 cm ; 10.5 kg Pcs: 1000/ carton

READY STOCK



Phone Stand



Screen Cleaner



Stylus



**Kube Metal 4 In 1 Pen**

KUBE

WIXD 505 - Grey/White WIXD 506 - Grey/Blue

XDDESIGN® Kube combines all your daily mobile needs in one stylus pen. The clip is designed to hold your mobile phone and clean your screen. The pen comes with a blue and black refill. Registered design®

Print Technique : UV, SC Preferred Print Location : Clip /Barrel

Max Print Size : 25 x 6 mm Product Size : 15 x 1.5 x 1.4 cm

Packing Details : 33.5 x 27 x 37 cm ; 160 pcs /carton ; gw/nw : 7.4 kg / carton

**WIMP 201 - VICHY**

Print Technique : UV, SC, ENG

Preferred Print Location : Barrel

Max Print Size : 8 x 40 mm

Product Size : 14x ø1.1 cm

Packing Details : 35 x 35 x 18 cm ;

300 pcs/carton; gw/nw: 11 kg/carton





ANTI-BACTERIAL

- Tested for Anti-Bacterial effectiveness
- Soft Touch, Special mirror effect on engraving
- German Dokumental® Ink



Blue Red Black Green

BILLUND

WIMP 261 - Black WIMP 262 - Blue WIMP 263 - Red WIMP 264 - Green

Giftology Anti-Bacterial Metal Ballpoint pen with soft rubberized finish and matt gun metal trims. Especially designed for laser engraving, including a special coating for your logo. With 1200 m writing length and German Dokumental® Ink.

Print Technique : ENG, UV, SC Preferred Print Location : Barrel Max Print Size : 50 x 6 mm

Product Size : 13.7 x ø1 cm Packing Details : 34 x 29 x 16cm ; 500pcs/carton ; gw/nw: 9.5/10.5kg /carton

READY STOCK



- German Dokumental® Ink
- 1200m Writing Length
- Soft Touch, Special mirror effect on engraving



Black Black/Blue Black/Green Black/Red

VOJENS

WIMP 265 - Black WIMP 266 - Black/Blue WIMP 267 - Black/Red WIMP 268 - Black/Green

Giftology Ballpoint pen with twist mechanism, body in solid black color and stylus in a wide range of colors. Contrast Gun metal trims. Especially designed for laser engraving, including a special coating for your logo to be properly engraved in matching color with the stylus. With 1200 m writing length and German Dokumental® Ink.

Print Technique : ENG, UV, SC Preferred Print Location : Barrel Max Print Size : 50 x 6 mm

Product Size : 14.2 x ø1cm Packing Details : 34 x 29 x 16cm ; 500pcs/carton ; gw/nw: 9.5/10.5kg /carton

# METAL WRITING INSTRUMENTS



**WIMP 211 - LOMMEL**  
 Print T : UV, SC, ENG      Print L : Front & Back  
 Max Print Size : 7 x 30 mm      Product Size : 13.6 x ø1.1 cm  
 Packing Details : 35 X 35 X 18 cm; 11 kg Pcs: 300/ carton



**WIMP 213- GISTEL**  
 Print T : UV, SC, ENG      Print L : Next to clip  
 Max Print Size : 7 x 30 mm      Product Size : 13.6 x ø1.1cm  
 Packing Details : 35 X 35 X 18 cm; 11 kg Pcs: 300/ carton

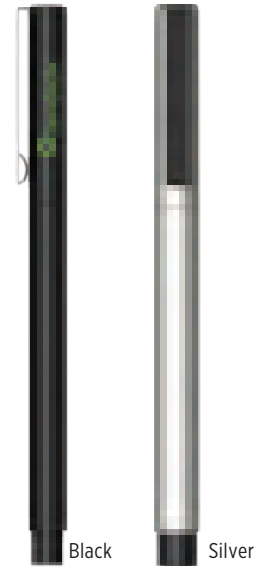

**AROL**  
**WIAP 758 - Black**    **WIAP 759 - Silver**  
 Print Technique : UV, SC    Preferred Print Location : Barrel

Max Print Size : 7 x 70 mm  
 Product Size : 14.4 X ø1 cm  
 Product Box Size : 17.5 X2.8X 6.5 cm  
 Packing Details: 54.5 X 32 X 12 cm; 500 pcs/carton; gw/nw: 10 kg/carton



**WIPB 101**  
 Product Size : 17.5 X2.8X 6.5 cm



READY STOCK

## XD COLLECTION



**WIXD 512 - METLIS**  
**XD COLLECTION** Metal Ballpoint pen with touch pen  
 Print T : UV, SC, ENG      Print Location : Barrel  
 Max Print Size : 40 x 6 mm  
 Product Size : 13.1 x ø1.1 cm  
 Packing Details : 51 x 30 x 21 cm ; 1,000 pcs /carton;  
 gw/nw: 15.0 kg /carton



**WIMP 207 - DINANT**  
 Print Technique : SC, ENG  
 Preferred Print Location : Barrel  
 Max Print Size : 8 x 40 mm  
 Product Size : 13.5 x ø1.1 cm  
 Packing Details : 32 x 26 x 22 cm;  
 500 pcs/carton; gw/ nw: 14 kg/carton



**MONS**  
**WIMP 204 - Black**    **WIMP 205 - Blue**    **WIMP 206 - Red**  
 Print Technique : UV, SC, ENG  
 Preferred Print Location : Barrel Clip  
 Max Print Size : 10 x 50 mm    x 30 mm  
 Product Size : 13.6 x ø1.1 cm    14.1 x 1cm  
 Packing Details : 32 X 26X 22 cm ; 500 pcs /carton ; gw/nw: 13 kg / carton



# METAL WRITING INSTRUMENTS



**WIGS 203 - TROFA**  
 Print T. : UV, SC, ENG  
 Print L. : Barrel  
 Print Size : 25 x 6 mm  
 Product Size : 13.8 x ø1.1 cm  
 Packing Details : 39X 31.5 X 48.5cm; 200 pcs /carton; gw/nw: 15 kg/carton



**WIGS 202 - OSTEND**  
 Print Technique : SC, ENG  
 Preferred Print Location : Barrel  
 Max Print Size : 8 x 40 mm  
 Product Box Size : 17.2 x 6.4 x 2.9 cm



**WIGS 201 - MURET**  
 Print T. : UV, SC, ENG  
 Preferred Print Location : Barrel  
 Print Size : 8 x 40 mm  
 Product Box Size : 17.2 x 6.4 x 2.9 cm  
 Packing Details : 36X 32 X 34cm; 100 pcs /carton; gw/nw: 12 kg/carton

READY STOCK

Stylus Pen



**MP 859 - TIUP**  
 Print T. : UV, SC, ENG  
 Print L. : Barrel  
 Print Size : 30 x 6mm  
 Product Size : 14 x 1.4 cm  
 Packing Details : 51.5 X 16 X 22.5 cm;  
 500 pcs /carton; gw/nw: 18 kg/carton

Black    Brown    Navy-Blue

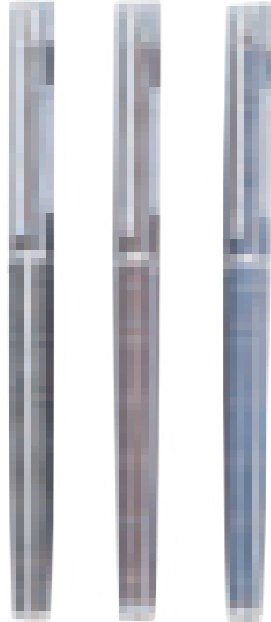

**MP 862 R - ZAM**  
 Print T. : UV, SC  
 Print L. : Next to clip  
 Print Size : 25 x 5 mm  
 Product Size : 14.3 x 1.2 cm  
 Packing Details : 45 X 31 X 16 cm;  
 500 pcs/carton; gw/nw: 15 kg/carton



**MP 828 - EZOR**  
 Print T. : UV, SC  
 Print L. : Next to clip  
 Print Size : 25 x 5 mm  
 Product Size : 14.3 x 1.3 cms

## PACKAGING SELECTION



**PB 762**  
 Product Size : 17 X2 X 4.2cm



**WIPB 101**  
 Product Size : 17.5 X2.8X 6.5 cm



**PB 1055 - Box**  
 Product Size : 17.5 X3X 7.3 cm



**PB 1053**    **GPMK 102**    **GPMK 103**  
 Black    Black    Grey



Die Handschrift der Werbung

### A Climate-Neutral Pens Factory in Germany

#### Climate-neutral company

To ensure sustainable development, an important aspect for us is to take a holistic view of the three components: economics, environment and society. In collaboration with Climate Partner, our site in Fischerbach is 100 % climate-neutral – this includes the processing of all uma pens. The unavoidable emissions are compensated through climate protection projects. We consciously focus on investing in our region. The forest protection project in Freiburg aims to protect our valuable rural environment.

Facts:

- Emissions of 2,636,777 kg CO<sub>2</sub> compensated to date
- 100 % climate-neutral processing in Fischerbach
- 25 product series manufactured, processed and delivered climate-neutrally

#### Climate-neutral product series from recycled PET

With the uma recycled PET PEN series, we created a solution to the current requirements of the market. The series offers the highest degree of sustainability. It is demonstrably certified and is the first European pen series made of recycled PET bottles. It was therefore self-evident that we would want to produce, process and transport this series completely climate-neutrally. The climate protection project that we support fights against the flood of plastic waste in our seas and perfectly completes the sustainability story of the uma recycled PET PEN series.

Facts:

- Emissions totalling 288,994 kg CO<sub>2</sub> compensated
- In addition to being climate-neutral, we ensure an upcycling process certified in accordance with the Global Recycled Standard.

## FACTS

**Climate neutral**  
Company  
ClimatePartner.com/13223-1909-1001

- entire uma NATURALS series is climate-neutral
- total of 3,057,962 kg CO<sub>2</sub> emissions compensated
- continuous investments and innovations for the environment and our home
- investment sum of around 160,000 euros

**Comparison manufacture of a pen:**

<p>ABS plastic kg CO<sub>2</sub>/ 1,000 pcs</p>	<div style="border: 1px solid white; padding: 5px; width: 30px; height: 30px; margin: 0 auto;">80,50</div>	<div style="border: 1px solid white; padding: 5px; width: 30px; height: 30px; margin: 0 auto;">40,00</div>	<p>recycled PET material kg CO<sub>2</sub>/ 1,000 pcs</p>
---	--	--	---



## recycled PET Pen PRO

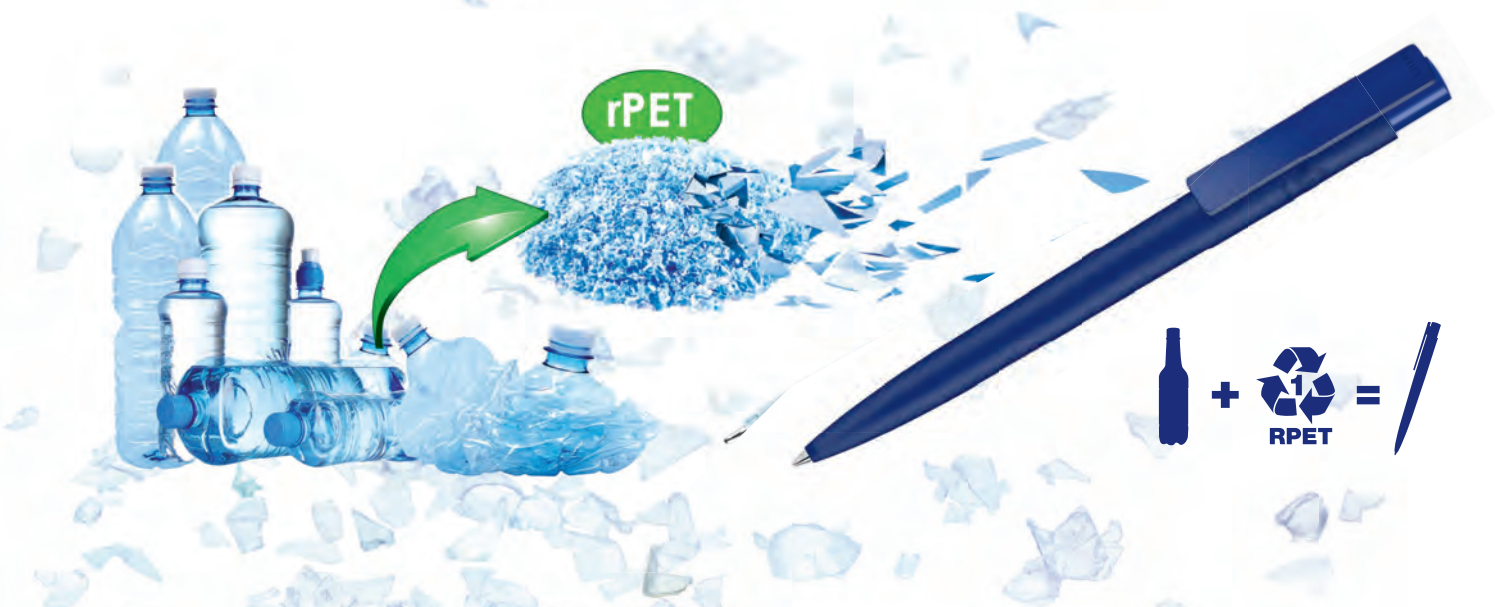



Dark Grey



Light Grey

READY STOCK

LUMUS STONE

WIMP 444 - Light Grey WIMP 445 - Dark Grey

Retractable metal ballpoint pen with reconstructed concrete or stone look and touch. Metal clip and push button matt chromed. From UMA- a Climate-Neutral Certified factory in Germany.

Print Technique : UV, SC

Print Location : Next to Clip

Max Print Size : 3 x 30 mm

Grey



Red



Black



Sky Blue



Navy Blue



Packing: PB 1053

MP 921 - STRAIGHT

UMA Metal Pens from germany

Print Technique : UV, SC, ENG

Product Size : 14 X ø1.2 cm

Print Location : Next to Clip

Box Size : 3 X 16.2 X 1.2 cm

Max Print Size : 30 x 5.5 mm

Packing Details : 39 X 24 X 30cm; 1000 pcs /carton; gw/nw: 18.5 kg/carton

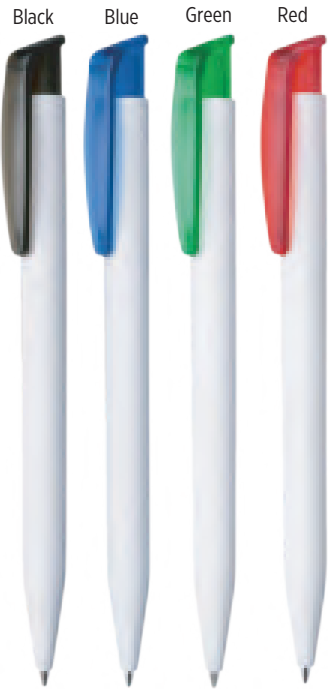

**PP 235 - PENNY FROZEN**

**UMA** Retractable ballpoint pen with white barrel and colored frosted clip  
 Print T. UV, SC Print L.: Barrel  
 Max Print Size : 40 x 6 mm  
 Product Size : 14.5 x ø1.3 cm  
 Packing Details: 40 X 28 X 39 cm;  
 2000 pcs / carton; gw / nw : 20.5 kg / carton



**PP 236 - PENNY**

**UMA** Retractable ballpoint pen  
 Print L.: Barrel  
 Print T.: UV, SC  
 Max Print Size : 40 x 6 mm  
 Product Size : 14.5 x ø1.3 cm

Purple



**PP 242 - STRIPE**

**UMA** Retractable ballpoint pen in white with transparent frosted soft-grip zone, fitting and clip shell  
 Print T. UV, SC Print L.: Barrel  
 M. Print Size : 40 x 6 mm  
 Product Size : 14.5 x ø1.3 cm  
 Packing Details: 39 X 29 X 34 cm;  
 1000 pcs / carton; gw / nw : 11 kg / carton

Green



Red



**PP 240 - SPEED**

**UMA** Retractable ballpoint pen with solid -colored transparent frosted barrel and clip, and silver retractable cap  
 Print T. UV, SC Print L.: Barrel  
 Max Print Size : 40 x 4 mm  
 Product Size : 15 x ø1.3 cm

READY STOCK



Red Royal Blue Green Grey Black Purple Aqua Blue White

**HAPPY**

**WIPP 601** - Black **WIPP 602**- White **WIPP 603** - Grey **WIPP 604** - Royal Blue  
**WIPP 605** - Aqua Blue **WIPP 606** -Red **WIPP 607** - Green **WIPP 608** -Purple

**UMA** Ballpoint pen with tungsten carbide ball (1mm) & 2200 linear meter writing length.  
 Print Technique : UV, SC Preferred Print Location : Clip Max Print Size : 35 X 7 mm  
 Product Size : 13.8 x ø1 cm



**PP 243 - FANTASY**

**UMA** Retractable ballpoint pen with soft- grip zone and push-button clip  
 Print T. UV, SC Print L. Barrel  
 M. Print Size : 40 x 4 mm  
 Product Size : 14.5 x ø1.3 cm



**PP 243 - FLAG**

**UMA** This pen from UMA-Germany represents the national flag colours of some Middle Eastern countries.  
 Print T. UV, SC Print L. Barrel  
 M. Print Size : 40 x 4 mm  
 Product Size : 14.5 x ø1.3 cm

\* Look for the **UMA** brand on the pen



# WRITING INSTRUMENTS



### PP 251 - ULTIMATE

Print Technique : UV, SC      Print Location : Barrel  
Max Print Size : 40 x 6 mm      Product Size : 14.4 x ø1.2 cm  
Packing Details : 39 X 29 X 24 cm ; 1000 pcs / carton ; gw / nw : 14.5 kg / carton



### PP 291 - KYOM

**UMA** Retractable ballpoint pen with metal clip & pusher in silver matt  
Print T. UV, SC    Print L. Barrel  
Max Print Size : 40 x 5.5 mm  
Product Size : 14 x ø1.2 cm



### PP 244 - CHILL

**UMA** Twist ballpoint pen with shiny solid colored body, heavy, matt chrome metal tip and metal clip  
Print T. UV, SC    Print L. Barrel  
Max Print Size : 40 x 6 mm  
Product Size : 14.5 x ø1.3 cm

READY STOCK

### Special Laser Engraving Logo

These pens have an outer coating specially designed for laser engraving which ensures brand color in mirror finish & matches the pen.



### BINJAI

#### STMK 150 - Blue

Ball pen with push-up mechanism, body in black solid color and upper ring in a wide range of matte, metallic colors. Black color clip and a wide printing area on barrel especially designed for laser engraving, including a special coating for your logo to be properly engraved in matching color with the upper ring. Jumbo cartridge and blue ink.

Print Technique : ENG    Preferred Print Location : Barrel  
Max Print Size : 50 x 6 mm    Product Size : 13.9 x ø1 cm  
Packing Details: 18 X 16 X 42.5 cm; 500 pcs /carton; gw/nw: 8 kg / carton

### German Ink

### Unique Slide Open Mechanism

### Smooth Rubber Touch

Black



Red



Dark Blue



Aqua Blue



### TORCY

#### WIPP 801 - Black

#### WIPP 802 - Red

#### WIPP 803 - Dark Blue

#### WIPP 804 - Aqua Blue

Torcy is a unique plastic pen with sliding open mechanism. With smooth touch finish for extra writing comfort. Including ca. 1200m writing length German blue ink refill with TC-ball for ultra smooth writing.

Print Technique : UV, SC      Preferred Print Location : Clip      Max Print Size : 30 x 6 mm  
Product Size : 14.2 x ø0.8 cm      Packing Details : 45 x 19 x 31cm ; 1000pcs /carton ; gw/nw : 9.7 kg / carton





Blue

White

Grey



- > Treated with Japanese Antibacterial agent produced with SIAA Member
- > Great Branding Space on clip

LEOVA

WIPP 818 - White    WIPP 819 - Grey    WIPP 820 - Blue

Giftology Pen is an object that every person keeps using and sharing. Sharing a pen means also transferring disease causing bacteria. Worried? Don't be! Because this pen is made from antibacterial agents produced with SIAA mark. With 99% Bacteriostatic Rate, these pens prevent growth and multiplication of bacteria on their surface.

Print Technique : SC, UV    Preferred Print Location : Clip    Max Print Size : 35 X 7 mm  
 Product Size : 14 x ø1cm    Packing Details : 54x34x18 cm ; 500 pcs /carton ; gw/nw : 5/4kg /carton

READY STOCK



- > Treated for bacterial effectiveness
- > 1200m writing length
- > German Dokumental® Ink.



Green

White

Blue



DEPOK

WIPP 821 - White    WIPP 822 - Blue    WIPP 823 - Green

Giftology Carbon pattern click action ballpoint pen that is treated with Antibacterial Silver-Ion technology in accordance with ISO 22196. With 1200 meter writing length and German Dokumental® Ink.

Print Technique : UV, SC    Preferred Print Location : Clip    Max Print Size : 8 X 35 mm    Product Size : 14 x ø1cm



# WRITING INSTRUMENTS

## Light-Up Your Brand



Blue

Black



DURBUY

WIPP 201 - Black WIPP 202 - Blue

Ballpen with twist open mechanism that lights up the barrel when you twist to open. Stylus on top.

Print T. : UV, SC, ENG Print L. : Barrel

M. Print Size : 10 x 50 mm Product Size : 13.5 x ø1.2 cm

Packing Details : 58 x 16 x 24 cm ; 500pcs /carton; gw/nw: 7.5 kg / carton

## Light-Up-Logo



Blue



Red



Orange



Green



Yellow

KENDARI

STMK 121 - Blue STMK 122 - Red STMK 123 - Orange STMK 124 - Green STMK 125 -Yellow

Led pointer ball pen with twist mechanism.

Print Technique : SC, ENG Print Location : Barrel Max Print Size : 30 x 6 mm

Product Size : 14.2 x ø1.3 cm Packing Details : 24 x 32 x 53 cm ; 1000pcs /carton; gw/nw: 14.5 kg / carton

READY STOCK



STMK 135 - CIMAHI

Micrometer ball pen with twist mechanism. With built-in ruler of 10cm. Blue ink.

Print Technique : SC

Print Location : Right and Left Sides

Max Print Size : 50 x 7 mm

Product Size : 1.1 x 14.8 cms

Packing Details : 32 x 22 x 43 cm ; 1000pcs /carton; gw/nw: 8.5 kg / carton

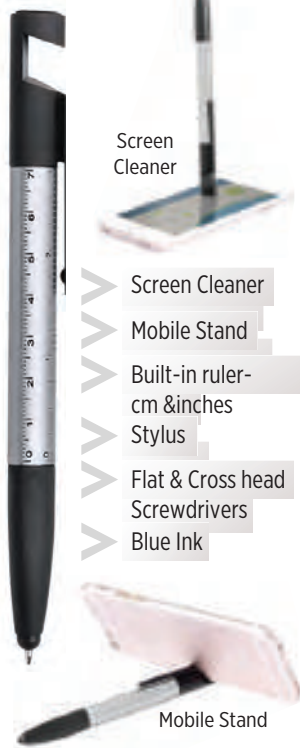

Screen Cleaner

Screen Cleaner

Mobile Stand

Built-in ruler-

cm & inches

Stylus

Flat & Cross head

Screwdrivers

Blue Ink

Mobile Stand

STMK 134 - DUMAI

Print T : SC, UV

Print L : Right and Left Sides

Max Print Size : 50 x 6 mm

Product Size : 15.5 x ø1.61 cm

Packing Details : 20 x 18 x 47 cm ;

500pcs /carton; gw/nw: 8.5 kg / carton

## Swiss Tip

## German Ink

Pink

Aqua Blue



WIPP 751 - Aqua Blue

WIPP 755 - Pink

Print T : UV, SC

Print L : Clip

Max Print Size : 25 x 4 mm

Packing Details : 48 X 31

X 20 cm; 1000 pcs/carton;

gw/nw: 9 kg/carton

## German Dokumental® Ink

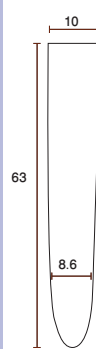

All White

White/Blue

White/Red



ELVAS

WIPP 812 - All White WIPP 813 - White/Blue WIPP 814 - White/Red

Print Technique : UV, SC Preferred Print Location : Next to clip

Max Print Size : 10 x 63 mm Product Size : 13.1 x ø1.1 cm

Packing Details : 50X 33 X 22 cm ; 9 kg Pcs: 1000/ carton



5-IN-1

- Pen
- Spirit Level
- Ruler (7 cm)
- Screw Driver
- Stylus Tip
- Solid Bamboo

eco-neutral



WIEN 876 - WILTZ

eco-neutral Multifunction bamboo pen with ruler (7cm) , spirit level, screw driver, stylus tip and ballpoint. Made from bamboo with aluminium clip. German Documental Ink (Blue)

Print Technique : UV, SC, ENG Preferred Print Location : Barrel Max Print Size : 25 X 10 mm  
 Product Box Size : 2.3 x 5.3 x 17 cm Packing Details : 27 x 31 X 37 cm ; 100 pcs / carton ; gw / nw : 15.5 kg / carton

READY STOCK



KUPANG

STMK 105 - White STMK 106 - Blue STMK 107 - Black STMK 108 - Red STMK 109 - Green  
 STMK 110 - Orange STMK 111 - Pink

Stylish ball pen with quadrangular body in frosted finishing. Push-up mechanism, original clip and available in a wide range of vivid colors. Blue ink refill.

Print Technique : SC, UV Preferred Print Location : Barrel  
 Max Print Size : 50 x 4 mm Product Size : 1 x 14.5 x ø0.8 cm  
 Packing Details : 28 x 28 x 55 cm ; 2000 pcs /carton; gw/nw: 13 kg / carton



ARCATA

STMK 143 - Heart STMK 146 - Wink

Ball pen with fun emoji designs in eye-catching yellow color. With push-up mechanism, soft body in glossy finish and original circular clip. Blue ink.

Print Technique : SC Preferred Print Location :  
 Max Print Size : SC, 50 x 5 mm Product Size : 14 x ø0.9 cm  
 Packing Details : 35 x 51 x 51 cm ; 1000 / carton ;  
 gw / nw : 12.5 kg / carton



# BAMBOO (ECO) PENS



Black

Blue

Green

Grey

- > Fun Colours
- > Matching Stylus
- > Bamboo Grip
- > Metal Pen



READY STOCK

AYTOS

WIMP 871 - Black    WIMP 872 - Grey    WIMP 873 - Blue    WIMP 874 - Green

**eco-neutral** Elegant combination of young & corporate colors with bamboo grip

Print Technique : UV, SC, ENG

Preferred Print Location : Barrel

Max Print Size : 25 X 10 mm

Product : 14.5 x ø1cm

Packing Details : 27 x 31 X 37 cm ; 100 pcs / carton ; gw / nw : 15.5 kg / carton



XD COLLECTION



WIXD 525 - BAMBOO PEN IN BOX

XD COLLECTION Bamboo ballpoint pen with silver finish in bamboo box.

Print Technique : UV, SC, ENG Preferred Print Location : Barrel

Max Print Size : 25 X 10 mm Product Box Size : 2.3 x 5.3 x 17 cm

Packing Details : 27 x 31 X 37 cm ; 100 pcs / carton ; gw / nw : 15.5 kg / carton

# ECO-FRIENDLY WRITING INSTRUMENTS



## STMK 126- CIREBON

Elegant ball pen with natural bamboo wood body and silver finish details. Presented in an individual black cardboard box.

Print T.: SC, ENG, UV      Print Location.: Barrel  
 Max Print Size: 50 x 6mm      Product Size: 14 x ø1 cm  
 Packing Details: 32 X 33 X 68 cm ; 14.5 kg Pcs: 1000/ carton

## STMK 127- SALATIGA

Set of push-up mechanism ball pen and mechanical pencil made in an original combination of natural bamboo wood and metallic finish accessories in shiny silver color. Presented in a cardboard case in wooden finishing. 0.7 mm Leads Included.

Print T.: SC, ENG, UV      Print Location.: Barrel  
 Max Print Size: 60 x 6 mm      Product Size: 13.8 x ø1.1 cm  
 Packing Details: 26 X 43 X 55 cm ; 14 kg Pcs: 300/ carton

## STMK 128- SUKABUMI

Eco- friendly bamboo pen with touch stylus. Blue ink. Jumbo refill.

Print Technique : SC, ENG, UV      Print Location : Barrel  
 Max Print Size : 60 x 6 mm      Product Size : 13.8 x ø1.1 cm  
 Packing Details : 20 X 31 X 45 cm ; 10 kg Pcs: 1000/ carton

READY STOCK

## eco-neutral

Wheat Straw Trims



Bamboo Body



SERANG

WIEN 101 - Natural    WIEN 102 - Blue    WIEN 103 - Green

**eco-neutral** Eco-Friendly push-up mechanism ball pen. Body in bamboo, with accessories in wheat straw, to encourage the use of natural raw materials.

Print Technique : UV, SC, ENG      Preferred Print Location : Barrel      Max Print Size : 6 x 50 mm  
 Product Size : 14 x ø1 cm      Product Size : 15 x ø1 cm      Product Size : 16 x ø1 cm  
 Packing Details : 48 x 31 x 22 cm ; 1000 pcs /carton ; gw/nw: 9.5 kg /carton



## ECO FRIENDLY STATIONERY

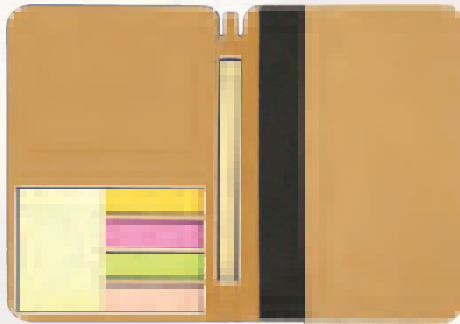

NUUK  
EFEN 108- Craft

**eco-neutral** Notepad that is ideal for meetings!! Consists of 70 sheets of 70 gsm paper, sticky notes to mark important points, business card pocket that can hold up to 10 cards and recycle material ballpoint pen.

Print Technique : SC, UV Preferred Print Location : Center Max Print Size : 60 x 40 mm  
Product Size : 14.5 x 11.5 x 1.5 cm Packing Details : 35.5 x 32 x 21.5 cm; 100 pcs/carton; gw/nw: 11 kg/carton

READY STOCK

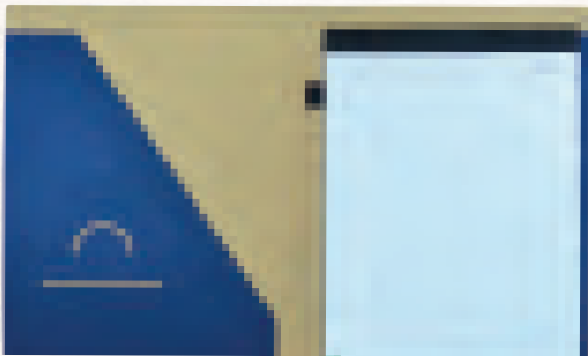

Blue Exterior

Craft Exterior



A4



FO 3340 - JUDAS

A4 folder with a button closure made from Eco-friendly material. Consists of a notepad with 40 pages, pen loop and pocket to keep documents and business cards.

Print Technique : SC Preferred Print Location : Top Right Max Print Size : 130 x 100 mm  
Product Size : 23.5 x 32.5 x 1.5 cm Packing Details : 52 x 38.5 x 35 cm; 40 pcs/carton; gw/nw: 14.5 kg/carton

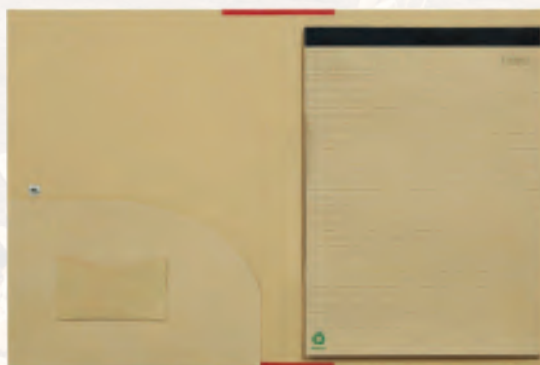

Black .....

Red .....



A4



FO 3341 - SORBUS

A4 folder with a button closure made from Eco-friendly material. Consists of a notepad with 70 pages, a pocket to keep documents and business cards.

Print Technique : SC Preferred Print Location : Center Max Print Size : 300 x 140 mm  
Product Size : 22.5 x 31.5 x 2 cm Packing Details : 51 x 35 x 34.5 cm; 30 pcs/carton; gw/nw: 17kg/carton



QUALITY

# VANCOUVER



- > Mobile Office
- > Practical Pockets On Outside & Inside
- > Notebook Included
- > Fits Tablets Upto 10 Inches



Grey



Blue

READY STOCK



**VANCOUVER**

ITXD 601 - Grey ITXD 602 - Blue

XDDESIGN® Vancouver makes it possible to work from anywhere. It's a compact yet multifunctional solution with pockets on both the outside and inside for all your daily necessities. The strong velcro secures all your belongings. There is a dedicated tablet pocket (max 10" tablets) with soft inside to protect your screen. This pocket can be transformed quickly to stand your tablet and you are ready to start working. The fabric portfolio comes with an A5 notebook with 64 cream pages of 70g/m2. Registered design®

Print Technique : SC, HT  
 Product Size : 30.9 x 24 x 2.5 cm

Preferred Print Location : Front  
 Packing Details : 28 x 51 x 33 cm; 20 pcs /carton ; gw/nw: 16 kg / carton

Max Print Size : 240 x 60 mm



# BALMAIN

PARIS

A4



FO 3287

**BALMAIN** Stylish designed portfolio with zipper closure, pen loop, ringbinde and several pockets to store your documents. Accessories not included  
Print Technique : UV, ENG, SC Preferred Print Location : Bottom Center Max Print Size : 90 x 305 mm  
Product Size : 27x 34 x 2.5 cm Packing Details : 53 x 32 x 37 cm; 12 pcs/carton; gw/nw: 10.5 kg/carton

# SANTHOME

- > Luxury Magnetic Metal Closure
- > Excellent Branding Space
- > Trendy Fabric Material
- > A4 Tech Folder With Ruled Notepad
- > Stylish And Practical

A4



PNFO 316 - FENKA

**SANTHOME** Fenka A4 modern portfolio with luxury magnetic metal closure. Inside: a tablet/phone stand, phone holder with see-through window which allows you to view and access your device. Suitable for most common phones for example iPhone 7 & Samsung S8. Including A4 notepad.  
Print Technique : SC, ENG Preferred Print Location : Metal Closure Max Print Size : 44 x 17 mm  
Product Size: 24 X 32 X 1.5 cm Packing Details : 47 x 26 x 33 cm; 25 pcs/carton; gw/nw: 15 kg/carton



Hans Larsen



Available in size

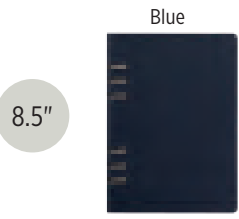

FO 3346(7") - SOMEL FO 3345(8.5") - CRUVA

**Hans Larsen** PU organizer with a textured cover. 6-ring binder allows you to turn the pages easily. Inside flap allows for keeping documents, a pen, 3 credit cards and identity card/business card. Always keep yourself organized! ( Pen not included )

Print Technique : ENG, EMB, SC Preferred Print Location : Bottom Center  
Max Print Size : 90 x 180 mm Product Size : 12.5 x 19 x 3.5 cm  
Packing Details : 56 x 34 x 21 cm; 40 pcs/carton; gw/nw: 14 kg/carton

Print Technique : UV, EMB, SC Preferred Print Location : Bottom Center  
Max Print Size : 130 x 220 mm Product Size : 17 x 23 x 3 cm  
Packing Details : 38.5 x 34 x 25 cm; 20 pcs/carton; gw/nw: 11 kg/carton





- > Made From Iconic Italian PU
- > A5 Portfolio
- > Luxury Silver Zipper
- > With Phone Stand

PNSW 102 - HERITAGE A5

**SWISS PEAK**® The A5 Swiss Peak Heritage collection speaks the language of modern elegance. Comes with iconic Italian PU cover with luxury silver zipper. The inside provides a phone stand, gadget holders, business cards slots, sleeves for your notes and papers along with A5 notepad.

Print Technique : SC, ENG Preferred Print Location : Front Max Print Size : 130 x 100mm  
 Product Size : 24 x 18 x 2.5 cm Packing Details : 26.5 x 32 x 41 cm ; 20 pcs /carton ; gw/nw: 9.2kgs / carton

## XD

- > A4 Portfolio
- > Front Sleeve With Utility Pockets
- > Includes Recycled A4 Notepad



A4



READY STOCK

PNXD 820 - OBAN

XD Oban is an A4 portfolio with 2 useful front pockets for mobile phone and cards. Also a larger pocket can be used to keep documents. Inside sleeve for documents, 4 card holders and pen loop. Polybag packing.

Print Technique : SC, EMB Preferred Print Location : Front Up Max Print Size : 120 x 80 mm  
 Product Size : 23.5 x 31 x 2 cm Packing Details : 32.5 x 25 x 43 cm ; 20pc /carton; gw/nw: 11.12 kg / carton

## SANTHOME



A4

- > Trendy Fabric Material
- > A4 Tech Folder With Ruled Notepad
- > Stylish And Practical

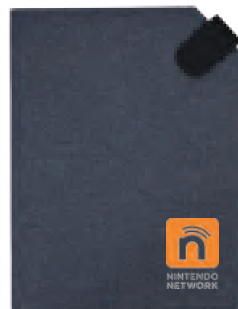

Navy Blue



Grey

FRIBLO

PNFO 320 - Grey PNFO 321 - Navy Blue

**SANTHOME** Friblo A4 portfolio made from trendy fabric material. Magnetic closure allows easy and secured closing, includes a ruled notepad, pen loop, pockets to hold credit cards, mobile phone etc.

Print Technique : SC, HT Preferred Print Location : Bottom Center Max Print Size : 130 x 230 mm  
 Product Size : 24 X 32 X 1.5 cm Packing Details : 54 x 27.5x 35 cm; 25 pcs/carton; gw/nw: 18 kg/carton



# CUSTOMISED DIARIES

## A5 Diary White

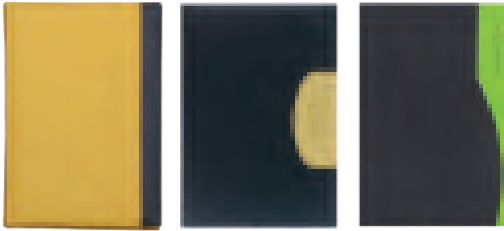

D 11

D 12

D 13

## Executive Daily Diary

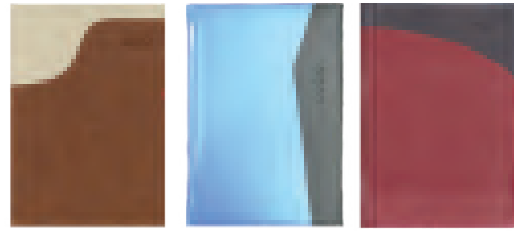

D 08

D 09

D 10

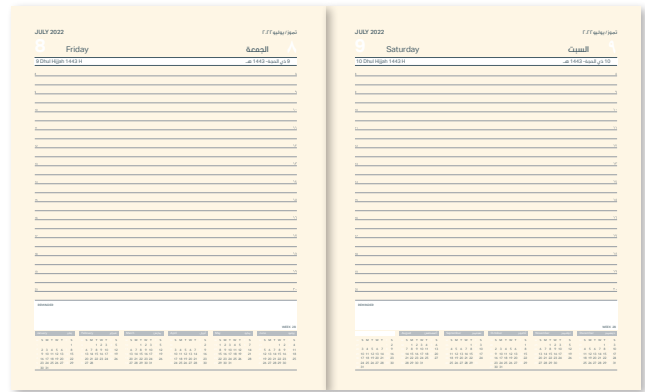
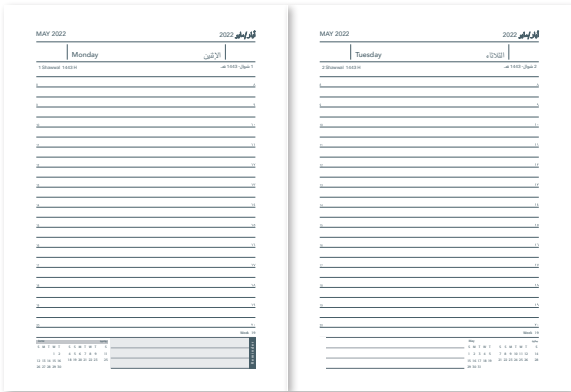

CUSTOM MADE

## Mini Executive Diary

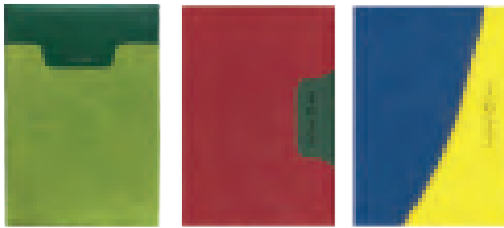

D 18

D 19

D 20

## Weekly Diary

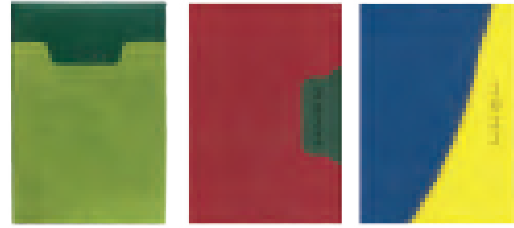

D 18

D 19

D 20



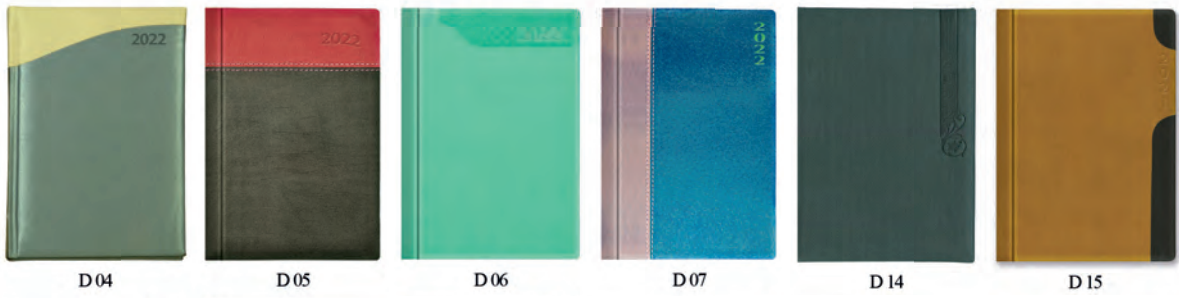

Customised Diaries - Check out our new covers on the previous page & on this one. The A5 & the Executive Daily continue to be the most popular versions users like.

CUSTOM MADE

A5 Cream Diary

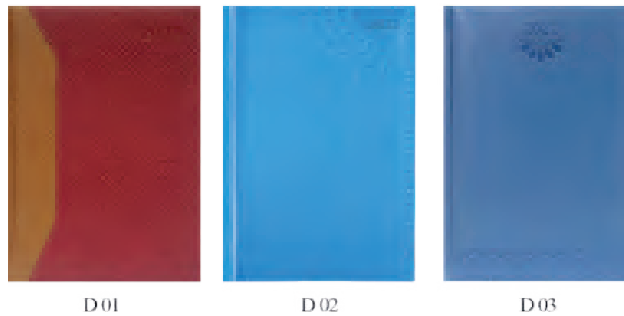



# ECO FRIENDLY DESKTOPS

# eco-neutral

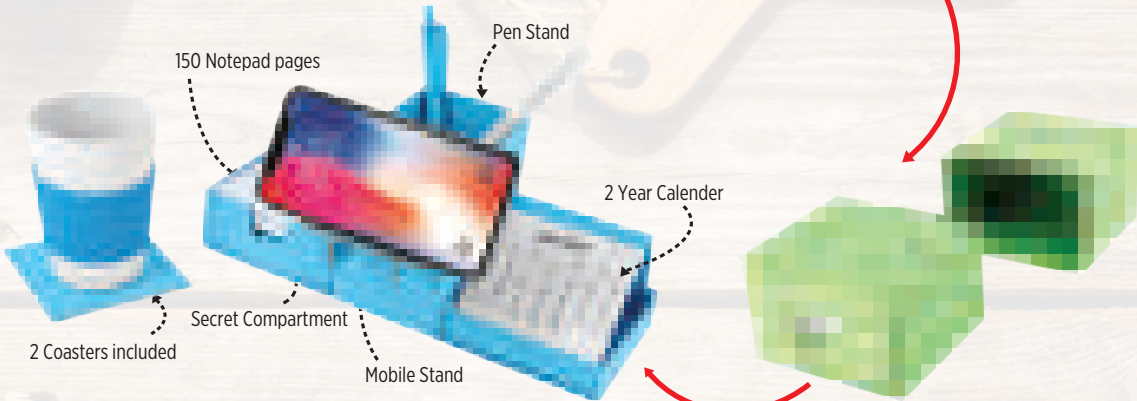

KALMAR

EFEN 210- Blue EFEN 211- Green EFEN 212- Red EFEN 213- Pink EFEN 214- Orange

**eco-neutral** Kalmar is a smart box that unfolds into a useful desk tool. Consists of a pen holder, 150 notepad pages, sticky notes in 5 different colors (25 sheets per color), a 2 year calendar and a secret box to keep those small things you want to hide from the world!

Print Technique : SC, UV

Preferred Print Location : Front

Max Print Size : 70 x 60 mm

Product Size : 10.5 X 10.5 X 7 cm

READY STOCK



VERNON

EFEN 201 - Blue EFEN 202 - Eco Green EFEN 203 - Black EFEN 204 - Red EFEN 205 - Pink

**eco-neutral** Vernon is a box that expands to be a useful workdesk tool. Comes with fun filled water marks, 6 pen holder slots, Memo pads 150 sheets of 70gsm, 30 paper clips and 2 year calendar.

Print Technique : UV, SC

Preferred Print Location : Side Max Print Size : 110 x 110 mm

Product Size : 11.5 X 11.5 X 11.5 cm

Packing Details : 48.5 X 36.5 X 46 cm; 48 pcs/carton; gw/nw: 16.5 kg/carton

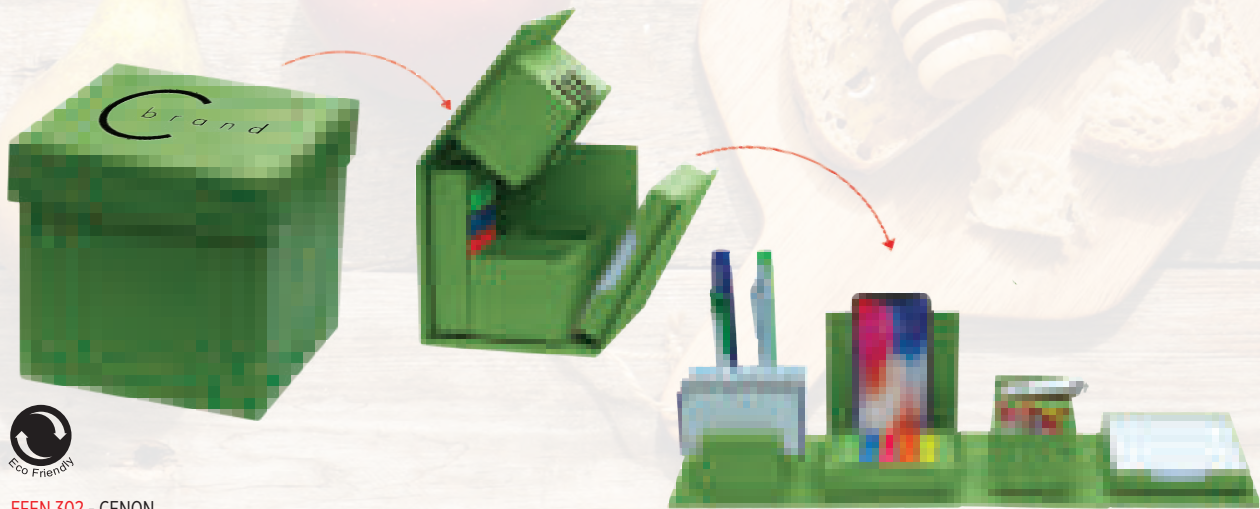

EFEN 302 - CENON

**eco-neutral** Cenon is a box that expands to be a useful desk tool for your workdesk. Comes with 4 holes to keep pens, 2 pcs coasters, Memo pads 150 sheets of 70gsm, 30 paper clips and 25 sheets PET sticky notes.

Print Technique : UV, SC Preferred Print Location : Side Max Print Size : 110 x 110 mm  
 Product Size : 11.5 X 11.5 X 11.5 cm Packing Details : 48.5 x 36.5 x 46 cm; 48 pcs/carton; gw/nw: 17.5 kg/carton



EFEN 109 - OOLO

**eco-neutral** A box that opens up and becomes a useful desk organizer. Includes 50 paper clips, 2 sets of 100 notepages and neon strips in 5 colours. This unique and compact designed product will surely grasp the attention of your customers.

Print Technique : SC, UV Preferred Print Location : Top Max Print Size : 70x70 mm  
 Product Size : 8.5 x 8 x 8.5 cm Packing Details : 44.5 x 27 x 42.5cm; 75 pcs/carton; gw/nw: 15 kg/carton

READY STOCK



Scan Below QR code to watch product video



EFEN 220 - Couvin

**eco-neutral** Cardboard cube with lid. Folds out to reveal small sticky notes in 5 different colours (25 sheets per color), included 30 paper clips, 4 pen holder slots, business card slots, a mobile stand and most importantly, a wireless charger. The Wireless charger has a 5W output. A perfect tech desk accessory for the modern desk!!

Print Technique : UV, SC Preferred Print Location : Front Max Print Size : 90 x 90 mm 44 x 17mm  
 Product Size : 10.5 x 10 x 10.5 cm Packing Details : 44.5 X 27 X 42.5 cm; 75 pcs/carton; gw/nw: 15 kg/carton



# WIRELESS SPEAKER



READY STOCK



Scan Below QR code to watch product video



- > Powerful Sound Wireless Speaker with 10 hours playtime
- > 5W Wireless Charger
- > Digital Alarm Clock
- > 4000 mAh Built-in powerbank

### ITSP 204 - SOMOTO

Somoto is a multifunctional portable wireless charger with alarm clock, a powerful 5 W wireless speaker and a 4000 mAh built in powerbank. The speaker uses wireless BT 5.0 for smooth connection and has an operating distance up to 10 metres. With hands-free function and pick up. The 4.000 mAh battery allows you to play music for up to 10 hours or charge your mobile phone twice (depending on the size of your phone's battery) Input: 5V/2A. Output: 5V/1A. Wireless output: 5V/1A 5W.

Print Technique : SC, UV Preferred Print Location : Top Max Print Size : 30 x 50 mm  
Product Size : 10.6 x 8.5 x 8.7 cm Packing Details : 21.5 x 21.5 x 24 cm; 8 pcs/carton; gw/nw: 4.5/5.0kg/carton



READY STOCK



- > Eco Friendly RPET Material
- > 5 Watts Wireless Charger
- > With Mouse pad, Desk Stand
- > Elegant Fabric gives a Rich appearance
- > Folds completely, hence a Travel-friendly accessory

**ITWC 153 - GORI**

@MEMORI Stay organized in your office or while traveling with our portable desk accessory, which can be packed flat. It can also unfold for use and maintain its position with a magnet. When in use, it can hold mobile phones, pens, serve as a mouse pad and a wireless charger - all in one. Great desk gift with an elegant linen finish and made sustainably with recycled rPET.

Print Technique : SC, UV, ENG Preferred Print Location : Front & Back  
 Max Print Size : (Front) 70 x 30 mm (Back) 260 x 30 mm  
 Product Size : 22 X 28 cm  
 Packing Details : 48.5 X 33 X 33 cm ; 30 pcs / carton ; gw / nw : 11/10 kgs/ carton



- > Eco Friendly RPET Material
- > 10 Watts Wireless Charger
- > With Mouse pad, Desk Stand
- > Elegant Fabric gives a Rich appearance
- > Folds completely, hence a Travel-friendly accessory

**ITWC 154 - VANI**

@MEMORI Stay organized in your office or while traveling with our portable desk accessory, which can be packed flat. It can also unfold for use and maintain its position with a magnet. When in use, it can hold mobile phones, pens, serve as a mouse pad and a wireless charger - all in one. Great desk gift with an elegant linen finish and made sustainably with recycled rPET.

Print Technique : SC, UV, ENG Preferred Print Location : Front & Back  
 Max Print Size : (Front) 70 x 30 mm (Back) 260 x 30 mm  
 Product Size : 22 X 28 cm  
 Packing Details : 48.5 X 33 X 33 cm ; 30 pcs / carton ; gw / nw : 11/10 kgs/ carton



# DESK TECH ACCESSORIES

## Innovative Adapter IDAPT®



Comes with above 4 pin / tip system

ED 447 - EZRA

IDAPT i2P is an innovative charging solution that eliminates cable clutter. IDAPT's patented interchangeable tip system allows you to safely charge almost any combination of portable devices quickly and easily. It is compatible with more than 5,000 electronic devices and combines style with simplified charging, perfect for today's mobile lifestyle.

Print Technique : SC Preferred Print Location : Front Bottom Center  
Max Print Size : 50 x 30 mm Product Size : 15.3 x 12.3 x 3.5 cm  
Packing Details : 58 x 39 x 33 cm; 24 pcs/carton; gw/nw: 14 kg/carton



ED 448 A - DOCK

IDAPT i3P is an innovative charging solution that eliminates cable clutter. IDAPT's patented interchangeable tip system allows you to safely charge almost any combination of portable devices quickly and easily. It is compatible with more than 5,000 electronic devices and combines style with simplified charging, perfect for everyone's mobile lifestyle

Print Technique : SC Preferred Print Location : Front Bottom Right  
Max Print Size : 35 x 20 mm Product Size : 17x 13.5x 3.5 cm  
Packing Details : 58 x 39 x 33 cm; 24 pcs/carton; gw/nw: 14 kg/carton

IDAPT IS SUBJECT TO PATENTS AND REGISTERED TRADEMARKS.  
DEVICES ARE SHOWN FOR ILLUSTRATION PURPOSES ONLY AND ARE NOT INCLUDED.

READY STOCK

Scan Below QR code to watch product video



Place your phone as per your convenient angle of view

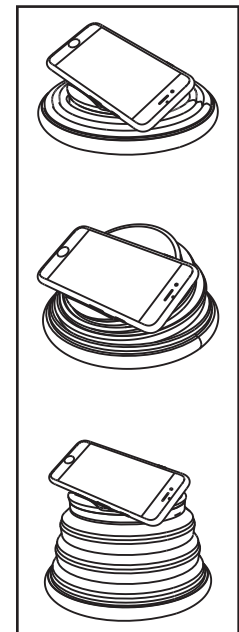

> 10 WATT Fast Wireless Charger

> Perfect For Home And Office Use



> Collapsible Silicon Design To Place Your Phone At Your Angle Of Convenience

> Six Different Mood Light Colors

ITWC 101 - SORRENTO

MEMORI Sorrento is a 10 Watt fast charge desk wireless charger with color changing moodlight. The collapsible silicon design allows for the phone to be positioned and charged at various angles depending on the use. The single touch button on the front allows for 6 different colors to be displayed with each touch. This useful device is a perfect eye catcher for your office or home! Compatible with all Qi enabled devices like Android latest generation, iPhone 8, 8S and X. Input: 5V/2A. Wireless Output: Output: 9V/1.10W.

Print Technique : UV Preferred Print Location : Front Max Print Size : 40 x 50 mm  
Product Size : 8.5 x ø14.5 cm Packing Details : 32 X 30 X 32 cm ; 40 pcs / carton ; gw / nw : 9.4 kg / carton





## AN INTELLIGENT MUG WARMER & PHONE WIRELESS CHARGER use @ home, in office.



READY STOCK



Reinforced Porcelain



Neither wireless charging nor heating coil switches on accidentally due to foreign objects

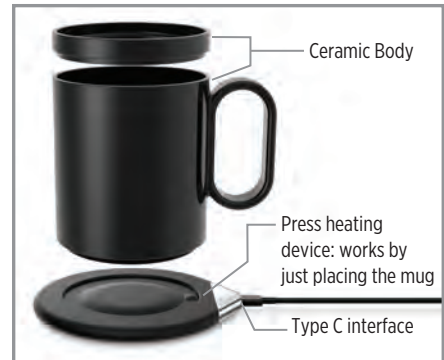

- > Material- High Temperature-Safe on touching while ON
- > Continuous 8 hours working
- > Mug 350ml
- > Constant temperature 55°C
- > Supports Qi standard wireless charging of phones incl. Apple & Android upto 10W.



Intelligent Foreign object Recognition identifies metal items that are accidentally place in panel



Wireless / Heating panel is waterproof

CRIVITS

ITHL 534 - WIRELESS CHARGER CUM CUP WARMER

Hans Larsen™ Works with own cup / mug only as effectice contact points work in tandem with each other. This intelligent base recognises metal foreign objects placed accidentally and are not meant to be warmed or charged, Panel is waterproof & touch safe while on. The radio bottom cooling sheet dissipates heat at high temperature & accumulates heat when temperature is low, Mode of heating - wireless induction.

Print Technique : SC, UV

Print Location : Plate & Front of Mug Max Print Size : (Plate) 10 x 10 mm

Product Size : ø8.5 x 10.5 cm

Packing Details : 59 X 41 X 35 cm; 24 pcs/carton; gw/nw: 19.5/18.5 kgs /carton



Play Modes:

- BT
- TF
- Aux Cable
- USB

VALUE

Giftology

6 Watts



ASTA

ITSP 107 -White ITSP 108-Silver

Giftology Asta soundbar with 2\*3W bluetooth speakers and 1200 mAh battery. Functions include Handsfree calling, 3.5mm Line in, USB/TF card play mode. Can also be used with the included audio cable. Packed in a nice gift box.

Print Technique : UV, SC Preferred Print Location : Front  
Max Print Size : 50 x 12 mm Product Size : 31.6 x 5.5 x 4 cm  
Packing Details : 35.5 x 38 x 15.5 cm; 10 pcs/carton; gw/nw: 5 kg/carton

USB Hub

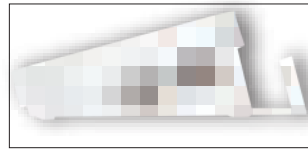

DT 641 - ETID

Mobile Holder with Sticky note pad, USB HUB. Additional Sticky note pad refill is provided with the article.

Print Technique : UV, SC Preferred Print Location : Front  
Max Print Size : 60 x 25 mm Product Size : 9.5 x 4.5 x 9.5 cm  
Packing Details : 51 x 32 x 25 cm 50 pcs /carton ; gw/nw: 10 kg/carton

VALUE

@MEMORI

Blue

Grey

Light up logo !!



PINSK

ITPB 793 - Grey ITPB 794 - Blue

@MEMORI Pinsk is a 2200 mAh powerbank that can be charged wirelessly on a docking station. Just place the powerbank on the docking station and the powerbank connects to the magnetic pins to start charging. The docking station has 2 USB outputs that can be used to charge your digital devices. The powerbank can also be charged with the micro USB cable. Input /output: 5V/1A.

Print Technique : SC, UV, DM Preferred Print Location : Front  
Max Print Size : 15 x 70 mm  
Print Technique : SC, UV Preferred Print Location : Charging Base  
Max Print Size : Dia 37 mm Product Size : 9.7 x 3.5 x 2.2 cm  
Packing Details : 32 X 27 X 12 cm ; 25 pcs / carton ; gw / nw : 4 kg / carton

READY STOCK

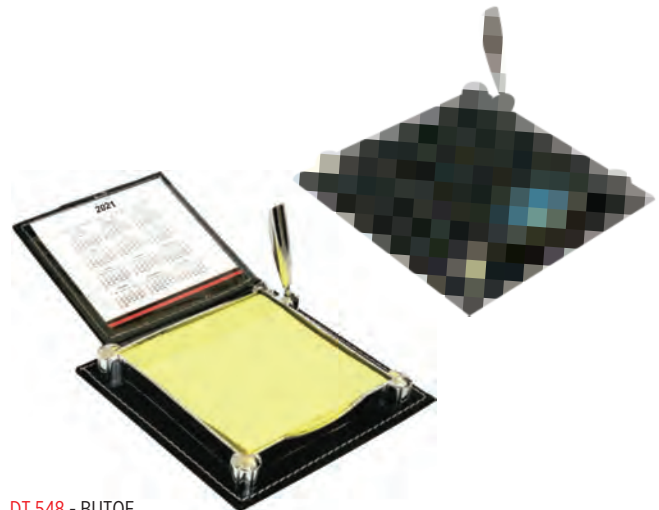

DT 548 - BUTOF

Budget Memo & Pen Holder

Print Technique : UV, SC, ENG Preferred Print Location : Front Plate  
Max Print Size : 30 x 10 mm Product Size : 13 x 12.5 x 2 cm  
Packing Details : 36 x 22 x 40 cm 50 pcs /carton ; gw/nw: 24.9 kg/carton

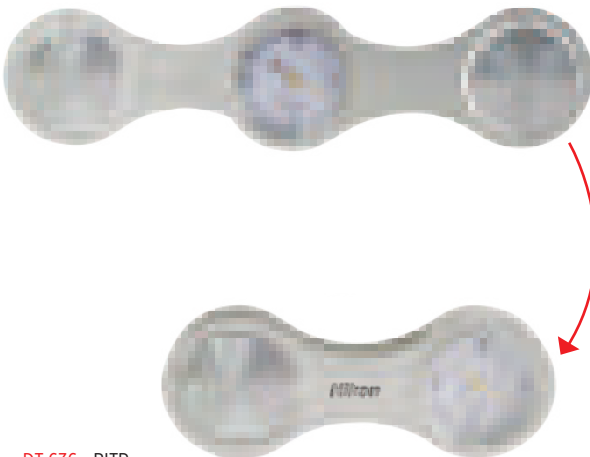

Folds

DT 636 - BITR

Foldable, heavy brushed metal clock with separate panel for logo branding. Packed in a white box.

Print Technique : SC, ENG, DM Preferred Print Location : Front  
Max Print Size : ø35 mm Product Size : 5 x 5 x 1.5 cm  
Packing Details : 35 x 22 x 15.7 cm; 60 pcs/carton; gw/nw: 6.8 kg/carton



DT 646 - LOMBL

Desktop Clock with Maze Game

Print Technique : UV, SC Preferred Print Location : Bottom  
Max Print Size : 60 x 15 mm  
Product Size : 8 x 10 x 4.3 cm  
Packing Details : 38 x 28 x 35.7 cm  
60 pcs /carton; gw/nw: 8 kg/carton



STAITI-98193-19

**Tonino Lamborghini** Silver plated foldable clock in Lamborghini exquisite packaging

Print Technique : SC, ENG Preferred Print Location : Top Bottom  
 Max Print Size : 40 x 10 mm Packing Size : 14.5 x 3.5 x 10.5 cm  
 Packing Details : 34.5 x 31 x 21.5 cm ; 30 pcs /carton gw/nw: 11.9 kg / carton



FIUMARA-98195-19

**Tonino Lamborghini** Silver plated mouse pad in Lamborghini exquisite packaging.

Print Technique : SC, ENG, UV Preferred Print Location : Top  
 Max Print Size : 70 x 20 mm Packing Size : 29 x 3.5 x 23 cm  
 Packing Details : 31 x 25 x 37.5 cm ; 10 pcs /carton gw/nw: 6.4 kg / carton



L001

**Tonino Lamborghini** Silver plated CD rack in Lamborghini exquisite packaging

Print Technique : SC, ENG Preferred Print Location : Front  
 Max Print Size : 30 x 15 mm Packing Size : 19 x 8 x 3 cm Box Size : 33 x 18.5 x 8 cm  
 Packing Details : 40.5 x 35.5 x 44.5 cm ; 10 pcs /carton gw/nw: 11.1 kg / carton



READY STOCK

Pierre Cardin  
PARIS

TCPC 770  
TRIOMPE



- >> PIERRE CARDIN desk clock
- >> Silver plated parts
- >> Quartz mechanism

Print Technique : SC Preferred Print Location : On Box  
 Max Print Size : 20 x 30mm Product Size : 5 x 2.2 x 2.2cm  
 Packing Details : 57 X 36 X 36 cm ; 96 pcs / carton ; gw / nw : 13.5 kg / carton



TCPC 769  
BELLENA

- >> PIERRE CARDIN desk clock
- >> Silver plated parts
- >> Quartz mechanism
- >> A connoisseur's collectable

Print Technique : SC Preferred Print Location : On Box  
 Max Print Size : 20 x 30mm Product Size : 7.2 x 5.5 x 0.5cm  
 Packing Details : 57 X 36 X 36 cm ; 200 pcs / carton ; gw / nw : 13.5kg / carton

Pierre Cardin  
PARIS

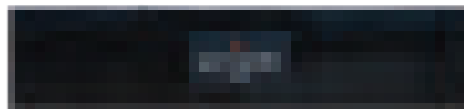

- >> PIERRE CARDIN letter opener
- >> Secured grip
- >> Silver PIERRE CARDIN logo



STPC 783  
TRAPANI

Print Technique : UV, ENG Preferred Print Location : Max Print Size : 5 x 15mm  
 Product Size : 19.5 x 1.2 x 0.5 cm Packing Details : 42X 31 X 29 cm ; 100 pcs / carton ; gw / nw : 12.4 kg / carton



# SILVER PLATED DESK ACCESSORIES

Pierre Cardin  
PARIS



### FEATURES :

- PIERRE CARDIN silver plated photo frame
- Silver PIERRE CARDIN logo
- Smooth premium metallic surface

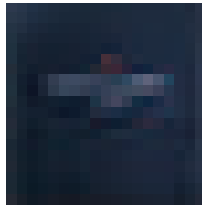

DTPC 776 - EUSTACHE

Print Technique : UV, ENG Preferred Print Location : Front  
 Max Print Size : 7 x 20 mm Product Size : 8.5 x 9.5 x 2.5 cm  
 Packing Details : 42 X 31 X 29 cm ; 66 pcs / carton ; gw / nw : 20.5 kg / carton

### FEATURES :

- PIERRE CARDIN silver plated keyholder with photo frame
- strong magnets to secure the key
- PIERRE CARDIN silver logo



MCPC 786 - GIVERNY

Print Technique : UV, ENG Preferred Print Location : Top  
 Max Print Size : 8 x 30mm Product Size : 16.5 x 17.5 x 1.5 cm  
 Packing Details : 57X 36 X 36cm ; 60 pcs / carton ; gw / nw : 32.5 kg / carton

READY STOCK

  
Pierre Cardin  
PARIS

  
Pierre Cardin  
PARIS

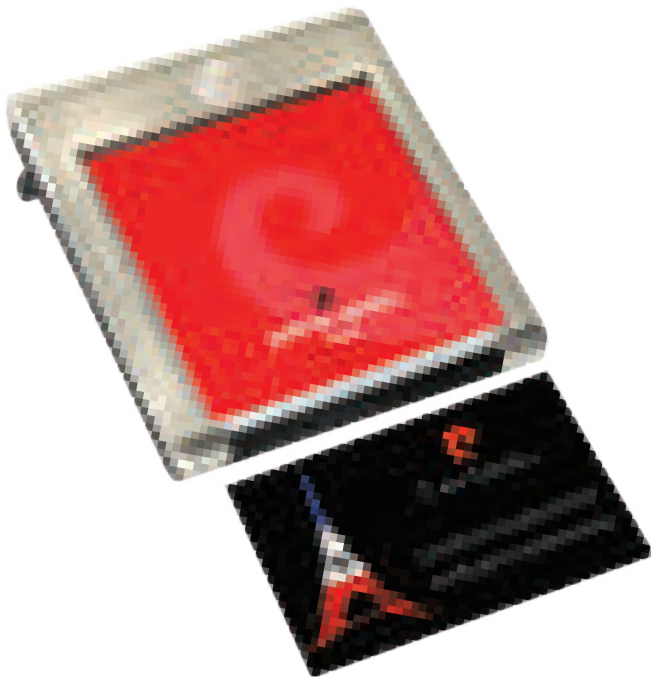

BITONO

DTPC 777 - Silver

\*Pierre Cardin Memo Pad \* Silver Pierre Cardin Logo  
 Print Technique : ENG Preferred Print Location : Top  
 Max Print Size : 10 X 30 mm Product Size : 9.5 X 11 X 3 cm  
 Packing Details : 42 X 23 X 32 cm ; 45 pcs / carton ; gw / nw : 18.65kg / carton



SEINE

DTPC 778 - Black

\*Pierre Cardin Phone/Card Stand \* Leather Pad to keep accessories \*Silver Pierre Cardin Logo  
 Print Technique : ENG, EMB, FO Preferred Print Location : Top  
 Max Print Size : 12 X 60 mm Product Size : 16.5 X 12.6 X 2 cm  
 Packing Details : 42 X 23 X 32 cm ; 39 pcs / carton ; gw / nw : 7.80kg / carton



TCPC 764  
CHAUMONT



TCPC 763  
MONTENA



TCPC 768  
MONCEAU



TCPC 767  
VILLETTE



TCPC 762  
FANONA



TCPC 761  
TUILER

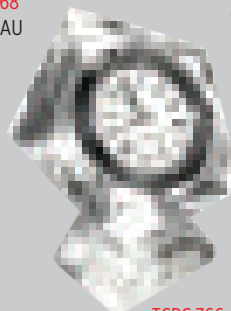

TCPC 766  
CLUNY

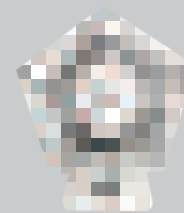

TCPC 765  
CASONA

**FEATURES :**

- > PIERRE CARDIN crystal clocks in 2 sizes
- > quartz movement
- > PIERRE CARDIN silver logo
- > perfect desk accessory!!

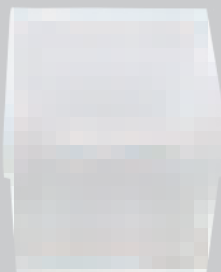

READY STOCK



CLPC 780  
VITERBO

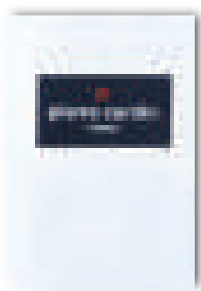

CLPC 779  
SULPICE

**FEATURES :**

- > Handheld PIERRE CARDIN calculator
- > Slide open mechanism
- > Silver plated PIERRE CARDIN logo
- > Digital comfortable display

Print Technique : SC  
Max Print Size: 40 x 60 mm

Preferred Print Location : On Box  
Product Size : 10.5 x 7 x 1 cm

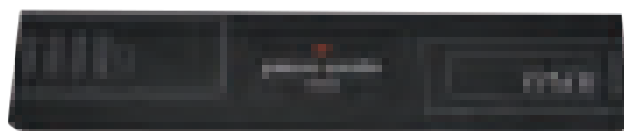

**FEATURES :**

- > Silver plated PIERRE CARDIN Logo
- > Electronic Footscale

STPC 784 - MOGADOR  
Product size : 31 x 4.2 x 1.3 cm  
Packing Details : 57 x 36 x 36cm; 200pc/carton; gw/nw: 20.7 kg /carton



# DESK & TABLE ACCESSORIES

## XDDESIGN®



Designed by:



Ryan McSorley  
Ireland



Cool & Handy Magnifier with Branding Space  
Ideal for Restaurants, Check-in Counters, Reception



UI 1275 - OPTO

XDDESIGN® Opto will help you avoid those annoying moments where you have trouble reading the small letters in a restaurant, bank, hotel, or any other place. The timeless design makes reading with glasses trendy again. Registered design®

Print Technique : SC Preferred Print Location : Front  
Max Print Size : 25 x 6 mm Product Size : 17 x ø3.8 cm  
Packing Details : 57 x 27.5 x 41 cm ; 120 pcs / carton ; gw / nw : 16 kg / carton



USB HUB + PHONE STAND

ITMK 122- BATAM

Desk phone holder with USB hub and light up logo and phone stand.  
Print Technique : ENG Preferred Print Location : Front  
Max Print Size : 50 X 10 mm Product Size : 7.6 X 3.4 X 6 cm  
Packing Details : 33.5 X 38 X 35 cm ; 200 pcs / carton ; gw / nw : 10 kg / carton

READY STOCK

## Giftology

- Mouse Pad
- USB Hub
- Excellent Branding Space



ITGL 815 - PITEA

Giftology Pitea is a multifunctional mouse pad with USB hub at the back. It has a Micro USB input and 3 USB 2.0 output. There is also a compartment to keep small items such as pins, eraser etc. (not included). Packed in a gift box.

Print Technique : UV, SC Preferred Print Location : Front  
Max Print Size : 20 x 60 mm Product Size : 18 x 22 x 2 cm  
Packing Details : 47 X 34.5 X 20.5 cm ; 50 pcs / carton ; gw / nw : 8.5 kg / carton



ITLC 903

ITLC 903



ITLC 901 & 902

ITLC 901 - AARHUS  
5mm Square shape  
sublimation mouse pad

ITLC 902 - ODENSE  
3mm Square shape  
sublimation mouse pad

ITLC 903 - HORSENS  
Round sublimation  
mouse pad



Heart



Wink



Sunglass

DAEJEON

SBMK 101 - Heart SBMK 102 - Sunglass SBMK 103 -Wink

Soft anti-stress ball with fun emoji designs in eye-catching yellow color.

Print Technique : SC, UV, Pad printing Preferred Print Location : Front Max Print Size : 30 x 30 mm

Product Size : ø6.2 cm Packing Details : 50.5 x 31.5 x 60cms ; 400 pcs / carton ; gw / nw : 7 kg / carton



SB 1021 - PAINTU

Paint Brush shape Stress Reliever

Print Technique : UV, SC Preferred Print Location : Front Base

Max Print Size : 8 x 40 mm Product Size : 3 x 12.5 x 1.5 cm

Packing Details : 63 x 30 x 32 cm; 500 pcs /carton; gw/nw: 9.8 kg/carton



SB 1012 - CLAPUC

Number 1 Shape Stress Reliever - White

Print Technique : UV, SC Preferred Print Location : Front Center

Max Print Size : 30x75 mm Product Size : 5.5 x 10 x 2.8 cm

Packing Details : 43 x 39 x 41 cm; 250 pcs/carton; gw/nw: 6.8 kg/carton



SB 1017 - STRAVE

Star Shape Stress Reliever - White

Print Technique : UV, SC Preferred Print Location : Front

Max Print Size : 20 x 20 mm Product Size : 8.5 x 8.5 x 3 cm

Packing Details : 48 x 35 x 48 cm; 500 pcs/carton; gw/nw: 10 kg/carton



SB 1013 - KEYOZ

Key Shape Stress Reliever - White

Print Technique : UV, SC Preferred Print Location : Front Top

Max Print Size : 45 x 15 mm Product Size : 6 x 11 x 2 cm

Packing Details : 61 x 35 x 28 cm; 250 pcs /carton; gw/nw: 6.8 kg/carton



SB 1001 - ROUNDA

Round Shape Stress Relievers Print Technique : SC, Pad Printing, UV

Preferred Print Location : Top Max Print Size : 35 x 15 mm

Product Size : ø6 cm

Packing Details : 70 x 35 x 33 cm; 250 pcs/carton; gw/nw: 7 kg/carton

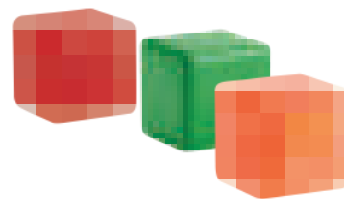

SB 1002

Square Shape Stress Relievers

Print Technique : UV, SC, Pad printing Preferred Print Location : Side

Max Print Size : 35 x 35 mm

Product Size : 5.5 x 5.5 x 5.5 cm

Packing Details : 57.5 x 30.5 x 29.5 cm; 250 pcs/carton; gw/nw: 7.2 kg/carton

READY STOCK



# LANYARDS, BADGE REELS & ID CARD HOLDERS



LY 884  
(Lanyard with detachable clip)



LY 885



LY 881



LY 886

## Lanyards

READY STOCK



Round Badge Reels # 755



Drop Shape Badge Reels # 801



Square Badge Reels # 756



Silver Chrome  
Badge Reels

# 802



# 803

## Badge Reels



# 754

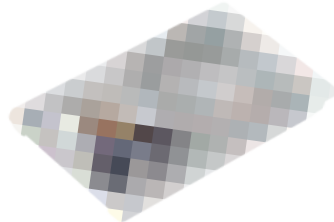

# 752



# 751



# 753

Best quality lanyards are available with us in all standard colors and sizes (10 mm, 15mm & 20mm).

- ✓ Fabric - nylon polyester.
- ✓ Clips - alligator and swivel clips
- ✓ We can customize lanyards according to customer requirements.

## ID Card Holders





DTLC 801 - LUBLIN  
Square Wooden Coaster

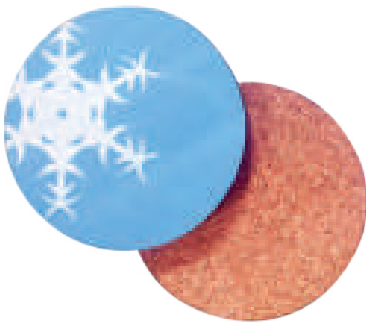

DTLC 804 - PLOCK  
Round Cork Coaster



DTLC 803 - MALBORK  
Round Wooden Coaster



DTLC 802 - RADOM  
Square Cork Coaster

READY STOCK

ABS ( ANTI-MICROBIAL TREATED ) KEYRING



Red



Blue



Green



White



MASTY

MTGL 843 - White MTGL 844 - Blue MTGL 845-Red MTGL 846-Green

Giftology A robust hygiene tool that allows the user to open doors and push buttons without any direct contact. Manufactured from strengthened materials for extra durability. This product contains antimicrobial technology that provides protection against the growth of harmful micro-organisms for the lifetime of the product. Supplied as a keychain.

Print Technique : UV, SC

Preferred Print Location : Front

Max Print Size : 30 X 6 mm

Product Size : 8 X 3.5 X 0.4 cm

Packing Details : 39.5 x 21.5 x 39 cm ; 1000 pcs / carton ; gw / nw : 10.3 kg / carton



# KEYRINGS

## Giftology

ANTI-MICROBIAL TOUCHLESS KEYHOLDER

- > Over 62% Copper- naturally anti-bacterial
- > Press/Push using tip-contactless



Foam with Sanitizer



MSKC 411 - SOROCA



2033 A - Leather Keyring  
 Print Technique :UV, SC, ENG, EMB  
 Preferred Print Location : Front  
 Max Print Size: 15 X 15 mm  
 Product Size : 7 X 2 X 0.7 cm



BEECH WOOD



KCMK 102 - MARFA  
 Smart nature line keychain. Obtained from cuts of beech wood, being all of them different and unique, each one with its own texture, thickness and color. With a wide printing area.  
 Print Technique : SC, ENG, UV  
 Preferred Print Location : Front/Back  
 Max Print Size : 40 x 24 mm Product Size: Variable  
 Packing Details : 40 x 36 x 40 cm; 800 pcs / carton;  
 gw / nw : 13 kg / carton



Black

Silver

KIMSE

MSKC 507 - Black MSKC 508 - Silver  
 Print Technique : UV, SC, ENG  
 Preferred Print Location : Front  
 Max Print Size : 8 x 30 mm  
 Product Size : 8.8 x 1.6 x 10 cm  
 Packing Details : 34.5 x 25 x 37 cm; 270 pcs /carton; gw/nw: 10.5 kg/carton

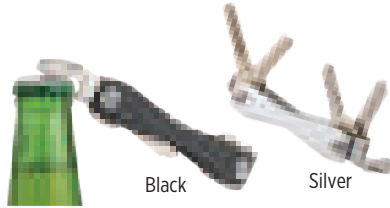

Black

Silver

SIMEK

MSKC 505 - Black MSKC 506 - Silver  
 Print Technique : UV, SC, ENG  
 Preferred Print Location : Front  
 Max Print Size : 7 x 50 mm  
 Product Size : 8.8 x 1.6 x 10 cm  
 Packing Details : 34.5 x 25 x 37 cm; 270 pcs /carton; gw/nw: 10.5 kg/carton



PERNIK

MTMK 101 - Black  
 Print Technique : SC, ENG  
 Preferred Print Location : Body of the Flashlight  
 Max Print Size: 20 X 6 mm  
 Product Size : 8.5 X Ø 1.4 cm  
 Packing Details : 16 X 22 X 53 cm  
 500 pcs / carton ; gw / nw : 7 kg / carton



KCMK 101 - DEVIN

Print Technique : ENG, SC  
 Preferred Print Location : Square Part  
 Max Print Size: 28 X 5 mm  
 Product Size : 1.7 X 6.7 X 0.3 cm  
 Packing Details : 34 X 29 X 49 cm  
 250 pcs / carton ; gw / nw : 10 kg / carton



MSKC 504 - ITIE

Print Technique : UV, SC, ENG, EMB  
 Preferred Print Location : Front  
 Max Print Size : 25 x 10 mm  
 Product Size : 9 x 2.1 x 0.6 cm  
 Packing Details : 40 x 29 x 35 cm; 200 pcs /carton; gw/nw: 10 kg/carton

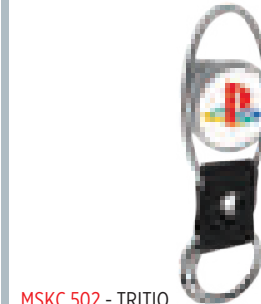

MSKC 502 - TRITIO

Print Technique : UV, SC, ENG, DM  
 Preferred Print Location : Front  
 Max Print Size : ø24mm  
 Product Size : 10.8 x 0.8 x 3.2 cm  
 Packing Details : 39 x 24 x 29 cm  
 200 pcs/carton; gw/nw: 10 kg/carton



KC 2055 - AWZIC

Print Technique : ENG  
 Preferred Print Location : Front Top  
 Max Print Size : 15 x 5 mm  
 Product Size : 3.8 x 9.5 cm  
 Packing Details : 37 x 28 x 25 cm; 200 pcs /carton  
 gw/nw: 11.24 kg /carton

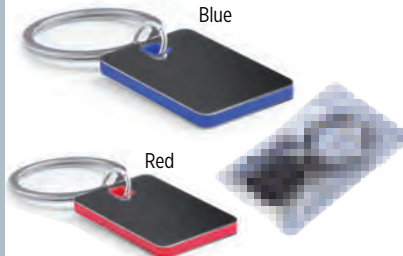

Blue

Red

TAEBACK

KCMK 106 -Blue KCMK 107 -Red  
 Print Technique : UV, SC, ENG  
 Preferred Print Location : Front, Back  
 Max Print Size : 25 x 35 mm  
 Product Size : 2.9 x 4 x 0.4 cm  
 Packing Details : 21 X 17 X 25 cm  
 200 pcs/carton; gw/nw: 4.5 kg/carton



SBKC 1005 - FOOTE

Football stress reliever keyring for FOOTBALL lovers  
 Print Technique : SC  
 Preferred Print Location : Top  
 Max Print Size : 5 x 5mm  
 Packing Details : 37 x 33 x 29.5 cm  
 500 pcs /carton ; gw/nw: 5.5 kg/carton

READY STOCK



Keyfetch the only online lost property service to connect owners and finders directly and anonymously, at a click.



*Socially Responsible Gift*



## Tag Anything!

Keys, Cards, Bags, Phones, Laptops....



## BENEFITS

- Allows customers / employees to protect their valuables and allows you to advertise your brand at the same time
- Promote your brand by putting your logo on millions of your customers everyday belongings, visible 24/7, 365 days a year.
- Be part of solving a real life problem
- Nurture your socially responsible corporate image.
- Works globally

## FEATURES

- Directly and anonymously connects owners and finders of lost items
- 100% anonymous patented messaging system
- Private label offering designed to put your logo on millions of everyday items

Keyfetch demonstration Video



Police Preferred Specification

Global Product Certification from Association of Chief of Police Officers (UK)

Keyfetch is the only service of its kind to have received an official accreditation from the UK Association of Chief Police Officers (ACPO) as part of the Secured by Design nationwide initiative.

[www.keyfetch.com](http://www.keyfetch.com)

READY STOCK

## How It Works!

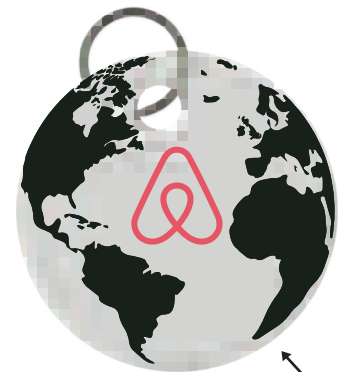

MSKF 101- Keyfetch

**KEYFETCH** is a smart keychain that allows the owner of the keychain to find his/ her lost keychain by connecting the owner & the finder anonymously.

Print Technique: UV, SC, ENG

Preferred Print Location: (Box) Front

Max Print Size: ø 32 mm

Product Size: ø3.2 cm

Packing Details : 30 x 28 x 18 cm ; 1000 pcs /carton ; gw/nw: 8.3 kg / carton



**C-secure** RFID Protection





**Genuine Leather**

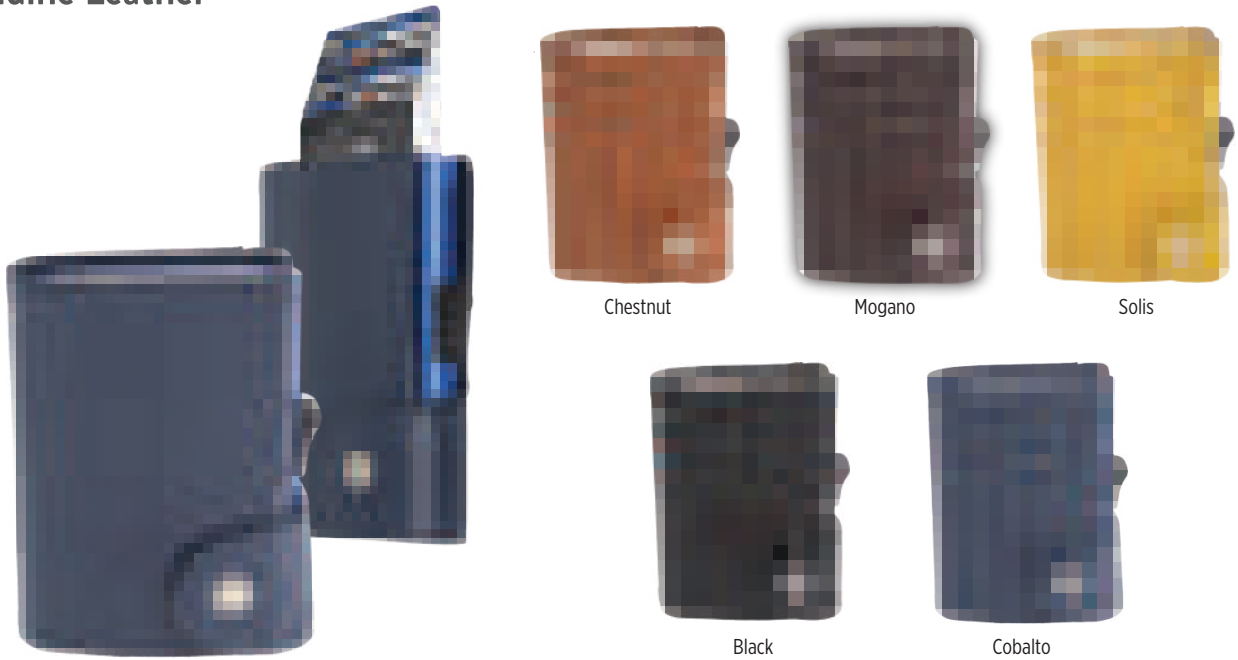

Chestnut

Mogano

Solis

Black

Cobalto

**MARALIK**

LASN 639 -Black LASN 640-Cobalto LASN 641-Chestnut LASN 642-Mogano LASN 643-Solis

No more electronic pickpocketing, broken or bent cards! This is the ultimate wallet for the regular card user. The XL cardholder in Genuine Italian Leather can hold up to 12 cards. The side button slider will push the cards up gradually. The wallet can hold your cash or more cards.

Product size : 9.5 x 6.7 x 1.2cm Packing Details : 45.5 x 27 x 21 cm ; 50 pcs /carton ; gw/nw: 5.8/7.0 kg / carton

**READY STOCK**



Black

Navy Blue

Brown

**VATRA**

LASN 631 - Black LASN 632 -Navy Blue LASN 633 - Brown

No more electronic pickpocketing, broken or bent cards! This is the ultimate wallet for the regular card user. The XL cardholder can hold up to 12 cards. The side button slider will push the cards up gradually. The wallet can hold your cash or more cards.

Product size : 10 x 7 x 2.5 cm Packing Details : 45.5 x 27 x 21 cm ; 50 pcs /carton ; gw/nw: 5.8/7.0 kg / carton



**c-secure**





Brown

Navy Blue

Black

OTACI

LASN 634 - Black LASN 635 - Navy Blue LASN 636- Brown

No more electronic pickpocketing, broken or bent cards! This is the ultimate wallet for the regular card user. The XL cardholder can hold upto 12 cards. The side button slider will push the cards up gradually. The wallet can hold your cash or more cards. Also features a coin pocket on the back.

Product size : 10 x 7 x 2.5 cm Packing Details : 45.5 x 27 x 24 cm ; 50 pcs /carton ; gw/nw: 6.5/9.0 kg / carton

READY STOCK



Silver

Black

CODRU

LASN 637 - Black LASN 638 - Silver

No more electronic pickpocketing, broken or bent cards! This is the ultimate wallet for the regular card user. The XL cardholder can hold up to 12 cards. The side button slider will push the cards up gradually.

Product size : 9.5 x 6.7 x 1.2cm Packing Details : 43 x 27 x 22 cm ; 100 pcs /carton ; gw/nw: 6.5/9.0 kg / carton



PRESENTING A WALLET  
THAT PROTECTS AGAINST FRAUD IN THE NEW WI-FI ERA.

# SANTHOME

SECURITY FOR YOU



### How the card holder protects?

The aluminium Cardprotector protects your most important plastic cards not only against bending and breaking, but also against malicious parties reading your RFID and NFC cards. RFID (Radio Frequency IDentification) cards contain a chip and an antenna for wireless communication. Examples of RFID cards include the Travel card, ID cards, the latest generation of credit cards and bank cards, as well as various access passes.

### Using the Cardprotector

The Cardprotector can hold a maximum of 7 cards. If only embossed cards are used, the capacity is 5 cards. Position the cards you use the most at the back or front and they will slide out sufficiently to be used. Slide out the cards with ONE movement of the slider on the side. The radio signal, although still greatly reduced, will now be sufficient for contact over a short distance. This means that you can use your RFID-NFC cards easily and securely. After use, slide your cards back into the Cardholder by pressing down on them lightly.

**PREVENT e-PICKPOCKETING PROTECTION**

**RFID: New Technology, New Threat Potential**

Designed to be used with PayPass, public transit, ID scan systems

RFID chip makes personal information easy to scan

Scanner sends signal to card

RFID

Radio Frequency Identification

Info on ID transmitted: name, ID/ account numbers

RFID chip activated by signal

**ePickpocketing: RFID Danger**

Scanners activate RFID chips

Pickpockets make portable scanners

Financial/ID information stored on scanner

Scans done while walking by no contact

Tourist destinations, transit stations, airports, and large crowds are target areas

Victims don't know until signs of theft appear

Emptied transit card or bank account, fraudulent charges

**Does Your Card Have an RFID Chip?**

blink payWave or blink logo

May still have RFID if no logos

**Cards likely to have RFID**

Credit / Bank Cards

Transit Cards

Driver's Licenses

All U.S. Passports Issued since Oct. 2006

Common Access Cards

**ePickpocketing Solution: Identity Stronghold Protection**

Our Santhome card holder blocks portable scanner signals

Prevent RFID chip activation and info transfer





**RFID**  
**BLOCKING**

Scan Below QR  
code to watch  
product video



- > Rfid Protection Wallet
- > Slide-Open Mechanism
- > Designed In Europe



Packaging

VITL

LASN 601 - Black LASN 602 - Navy Blue LASN 603 - Pink LASN 604 - Camel LASN 605 - Brown

SANTHOME Cardholder cum Wallet with RFID protection . Designed in Europe.

Print Technique : SC, UV, ENG, EMB

Preferred Print Location : Front Top Max Print Size : 50 x 50 mm

Product Size: 7 x 9.8 x 2 cm

Packing Details : 42.6 x 25.3 x 20.7 cm ; 50 pcs /carton ; gw/nw: 8.5 kg / carton

**READY STOCK**

**Genuine Leather**



Silver



Black



Brown



Packaging

> Rfid Protection Card Holder

> Slide-Open Mechanism

> Can Hold Upto 6 Embossed Cards

> Designed In Europe



Packaging



KLOY

LASN 606 - Black LASN 607 - Silver

SANTHOME Cardholder with RFID protection. Designed in Europe.

Print Technique : SC, UV, ENG

Preferred Print Location : Front Top

Max Print Size : 58 X 74 mm

Product Size : 9.5 x 6.2 x 0.8 cm

Packing Details : 42.6 x 25.3 x 38.3 cm ; 100 pcs /carton ; gw/nw: 13.6 kg / carton

CIKAW

LASN 609 - Brown

SANTHOME Cardholder cum Wallet with RFID protection and crafted from Genuine leather. Designed in Europe.

Print Technique : SC, ENG

Preferred Print Location : Aluminium Cardholder Back

Max Print Size : 70 x 50 mm

Product Size : 7 x 10 x 2.5 cm

Packing Details : 42.6 x 25.3 x 20.7 cm ; 50 pcs /carton ; gw/nw: 8 kg / carton



# CARDHOLDERS

## SANTHOME GENUINE LEATHER

Box: PB1041



CH 151 - LITHIS

**SANTHOME** Metal cardholder with Genuine grained leather covering. Can hold up to 20 Business Cards. Packed in a velvet pouch and presented in a textured two piece box.

Print Technique : ENG Preferred Print Location : Front Bottom  
Max Print Size : 40 x 30 mm Product Size : 6 x 10 x 1 cm  
Packing Details : 59.5 x 25 x 32 cm ; 200 pcs /carton ; gw/nw: 23.2 kg / carton

## SANTHOME GENUINE LEATHER



6003 - UTTUN

Print Technique : ENG, EMB, FO Preferred Print Location : Front Bottom Right  
Max Print Size : 25 x 55 mm Product Size : 7 x 10.5 x 1 cm

## Giftology



White



Black

MITSE

CHGL 780 - White CHGL 779 - Black

**Giftology** Smooth metal cardholder with PU covering. Can hold up to 20 business cards

Print Technique : SC, UV, ENG Preferred Print Location : Body  
Max Print Size : 10 x 65 mm Product Size : 6.5 x 9.3 x 1.2 cm  
Packing Details : 47 x 33 x 28cm; 200 pcs /carton ; gw/nw: 15.5 kg / carton



Brown



CHGL 775 - CARFO

**Giftology** Carfo is a cardholder that can hold upto 25 business cards. The cardholder folds itself and stands on the desk enabling easy access to your business cards. Stylish, easy to carry and compact design.

Print Technique : SC, ENG Preferred Print Location : Front  
Max Print Size : 80 x 20 mm Product Size : 9.5 x 6.5 x 1 cm  
Packing Details : 39 X 37 X 14.5 cm; 100 pcs/carton; gw/nw: 9.5 kg/carton

READY STOCK

## Giftology



MTGL 803 - TETOVO

**Giftology** RFID secured case that sticks to the back of your phone and can also be used as a phone stand or phone grip.

Print Technique : SC, UV Preferred Print Location : Front  
Max Print Size : 65 x 20 mm Product Size : 8.8 x 5.8 cm  
Packing Details : 31.5 X 21.5 X 54 cm ; 500 pcs/carton; gw/ nw: 13 kg/carton

## eco-neutral



Dark Grey Exterior

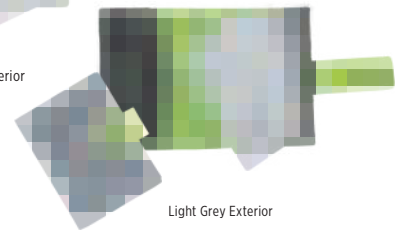

Light Grey Exterior



CH 139 - TRAILL

**eco-neutral** Pocket Cards Holder in attractive color combinations with eco-friendly felt jacket

Print Technique : SC Preferred Print Location : Center  
Max Print Size : 50 x 90 mm Product Size : 8.5 x 11 x 1 cm  
Packing Details : 54.5 x 27 x 30.5 cm; 200 pcs/carton; gw/nw: 7 kg/carton



Giftology

RFID BLOCKING



Brown



Navy Blue

SNEEK

CHGL 802 - Navy Blue CHGL 803 - Brown

Giftology Grained PU leather cardholder with anti-skimming RFID protection. Can hold up to 10 cards. Features a bill pocket. Packed in a gift box.

Print Technique : SC, ENG, UV Preferred Print Location : Front

Max Print Size : 40 x 70 mm Product Size : 7 x 9.8 x 2 cm

Packing Details : 42 x 31.5 x 24.5cm ; 100 pcs/carton ; gw/nw: 11 kg / carton

SANTHOME

RFID BLOCKING



HIBRID

- RFID Card Protection
- Slide Open Mechanism
- Can Hold Up to 7 Cards
- Pocket For Currency & Other Valuables

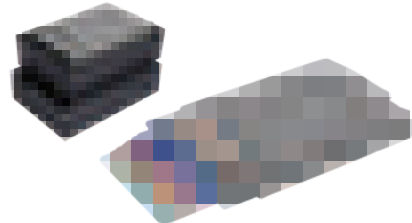

CHSN 802- DEVA

SANTHOME The aluminum credit card holder protects your most important plastic cards against bending and breaking. The card holder can hold a maximum of 7 cards. The extra pockets for currency & business cards makes it a complete wallet. The RFID blocking material protects against identity theft & electronic pick pocketing.

Print Technique : SC, ENG

Preferred Print Location : Front

Max Print Size : 40 x 40 mm

Product Size : 11 x 7.2 x 1.2 cm

Packing Details : 48 x 32 x 30 cm ; 100 pcs /carton ; gw/nw: 18 kg / carton

Giftology - Blues



RFID BLOCKING

Say no to RFID/NFC theft!



- RFID/NFC Protection
- Cardholder Cum Wallet
- Space To Store Currency
- Can Hold Up to 6 Embossed Cards



CHGL 772 - BORO

Giftology

Print Technique : SC, ENG Preferred Print Location : Front

Max Print Size : 70 x 90 mm Product Size : 8.5 x 11 x 1 cm

Packing Details : 49 x 38 x 26 cm ; 100 pcs/carton ; gw/nw: 10.5 kg/carton



Red



Blue



Green

Easy Pull-Up Mechanism to Remove Cards

Excellent Branding Space

RFID Security Technology

RFID BLOCKING



READY STOCK

MANADO

ITMK 118 - Blue ITMK 119 - Red ITMK 120 - Green ITMK 121 - Orange

Witty design cardholder with Slide and Remove mechanism. RFID (Radio Frequency Identification) security technology that keeps card data safe. Capacity up to 5 cards, in a wide range of vivid colors.

Print Technique : SC, UV

Preferred Print Location : Front

Max Print Size : 70 X 45 mm

Product Size : 6.2 X 10 X 1.1 cm

Packing Details : 34 X 26 X 58 cm ; 16 kg Pcs: 500/ carton

XD COLLECTION



RFID BLOCKING

- RFID Protection
- Great Logo Space
- Easy Access Opening
- Value Proposition !

ITXD 727 - SMART CARD

XD Slim down your wallet with this elegant minimalistic wallet design. The wallet can hold up to 8 credit cards. Ideal for credit cards, bills and business cards. With anti-skimming protection. It blocks 100% of all known RFID/NFC frequencies.

Print Technique : SC, UV Preferred Print Location : Front

Max Print Size : 65 x 40 mm Product Size : 8.8 x 5.8 cm

Packing Details : 39 X 25 X 42 cm ; 500 pcs/carton ; gw/nw: 16.02 kg/carton



RFID BLOCKING



Blue



Black



Red

PADANG

ITMK 114- Black ITMK 115- Red ITMK 116- Blue

Card holder with RFID blocking technology to protect your cards from identity theft, breaking and damage. Can hold up to 12 cards.

Print Technique : SC, UV, ENG Preferred Print Location : Front

Max Print Size : 50 x 25 mm Product Size : 8.9 x 5.8 x 0.7 cm

Packing Details : 19 X 27 X 42 cm ; 13.5 kg Pcs: 400/ carton

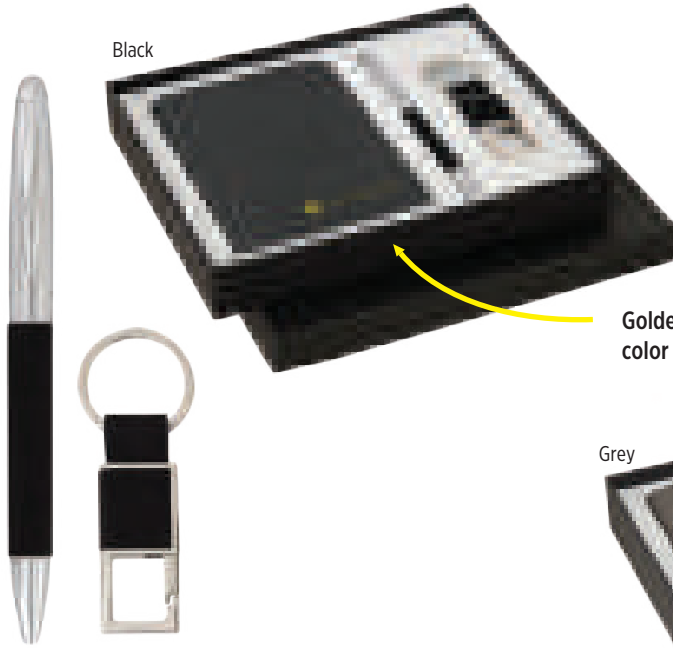

Black

Golden base color on Engraving



Passport Holder



Grey

Black base color on Engraving

READY STOCK

PINTIM

GSGL 103 - Black GSGL 104 - Grey

Giftology Pintim is a gift set consisting of coarse grained passport holder, a metal pen and a metal key chain. Its modern material is such that on engraving, golden color comes up in black and black color come up in grey. Packed in an elegant gift box.

(Passport Holder) Print Technique : FO, ENG, EMB

Preferred Print Location : Front Bottom

Max Print Size : 80 x 120 mm

(Pen) Print Technique : SC, ENG

Preferred Print Location : Barrel

Max Print Size : 35 x 7 mm

(Key Chain) Print Technique : SC, ENG

Preferred Print Location : Front

Max Print Size : 15 x 18 mm

Product Box Size : 16 X 20.5 X 3 cm

Packing Details : 48 x 35 x 39 cm; 40 pcs/carton; gw/nw: 13 kg/carton

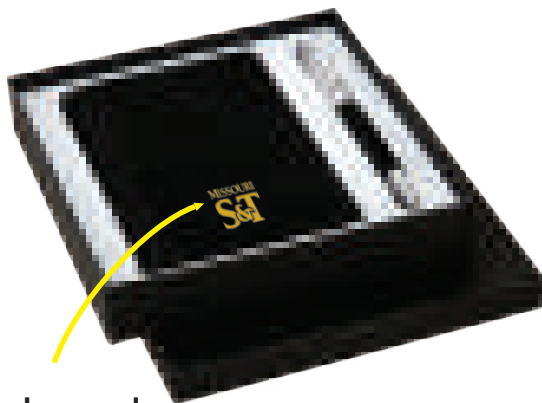

Golden base color on Engraving



Passport Holder



LOTIK

GSGL 101 - Black

Giftology Lotik is a gift set consisting of coarse grained passport holder and leather wrapped ballpoint metal pen. Its modern material is such that on engraving, golden color comes up in black and black color come up in grey. Packed in an elegant gift box.

(Passport Holder) Print Technique : FO, ENG, EMB

Preferred Print Location : Front Bottom

Max Print Size : 80 x 120 mm

(Pen) Print Technique : UV, SC, ENG

Preferred Print Location : Barrel

Max Print Size : 35 x 7 mm

Product Box Size : 16.5 X 16.5 X 3 cm

Packing Details : 38 x 38 x 38 cm; 40 pcs/carton; gw/nw: 11 kg/carton



# Giftology



Passport Holder



Cardholder

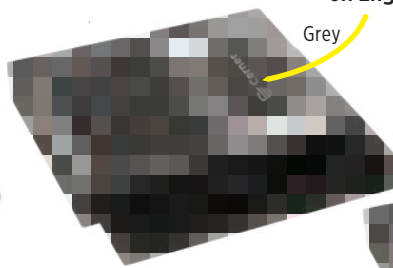

Black base color on Engraving

Grey

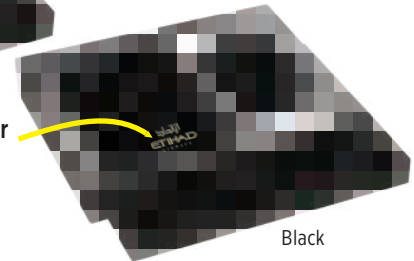

Golden base color on Engraving

Black

KRIMT

GSGL 105 - Black GSGL 106 - Grey

Giftology Krimt is a gift set consisting of coarse grained passport holder and card holder. Its modern material is such that on engraving, golden color comes up in black and black color come up in grey. Packed in an elegant gift box.

(Passport Holder) Print Technique : FO, ENG, EMB

Preferred Print Location : Front Bottom

Max Print Size : 80 x 120 mm

(Card Holder) Print Technique : SC, ENG

Preferred Print Location : Front

Max Print Size : 80 x 30 mm

Product Box Size : 16 X 20.5 X 3 cm

Packing Details : 48 x 35 x 39 cm; 40 pcs/carton; gw/nw; 13 kg/carton

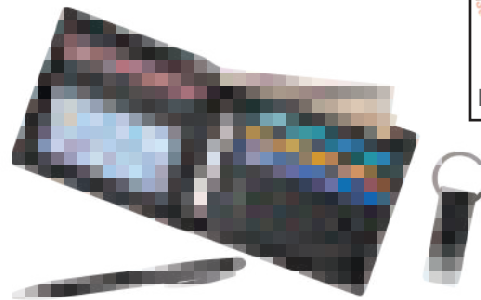
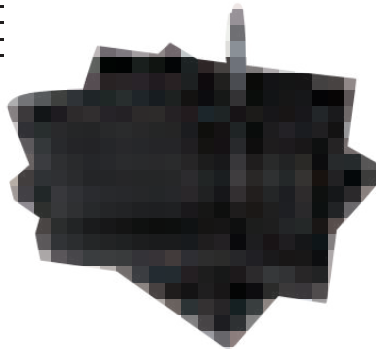

READY STOCK

GSSH 802- SHUMEN

Swiss Gift set consisting of a leather wrapped ballpoint pen, leather keychain and men's wallet with 6 credit card pockets.All packed in a nice gift box!

(Box) Print T : SC, UV, ENG

Print L : Front Plate

Max Print Size : 35 x 10 mm

(Wallet) Print T : EMB, ENG, FO

Print L : Front Center

Max Print Size : 70 x 90 mm

(Pen) Print T : ENG, SC, UV

Print L : Next to clip

Max Print Size : 35 x 5 mm

(Key Chain) Print T.: ENG, SC

Print L : Top/ Front

Max Print Size : 30 x 10 mm

Product Box Size : 18.2 x16.5 x 3.2 cm

Packing Details : 42 x 38.5 x 56.5 cm; 60 pcs/carton; gw/nw; 16.4 kg/carton



GSSH 803- YAMBOL

Swiss Gift set consisting of a leather wrapped ballpoint pen, leather keychain, men's wallet with credit card pockets and coin pocket.All packed in a nice gift box!

(Box) Print T : SC, UV, ENG

Print L : Front Plate

Max Print Size : 35 x 10 mm

(Pen) Print T : ENG, SC, UV

Print L : Next to clip

Max Print Size : 35 x 5 mm

(Wallet) Print T : EMB, ENG, FO

Print L : Front Center

Max Print Size : 70 x 90 mm

(Key Chain) Print T.: ENG, SC

Print L : Top/ Front

Max Print Size : 30 x 10 mm

Product Box Size : 18.2 x 16.5 x 3.2 cm

Packing Details : 42 x 38.5 x 56.5 cm; 60 pcs/carton; gw/nw; 16.4 kg/carton



# GIFT SETS



### GSSH 801- SLIVEN

Anyang gift set consisting of passport holder, keychain and pen in matching materials. Packed in a gift box.

(Passport Holder) Print T : FO , ENG, EMB      Print L : Front Bottom      Max Print Size : 80 x 120 mm

(Pen) PrintT : UV, SC, ENG      Print L : Barrel      Max Print Size : 35 x 5 mm

(Key Chain) Print T : SC, ENG      Print L : Front      Max Print Size : 30 x 10 mm

Product Box Size :16 X 20.5 X 3 cm      Packing Details : 42 X 38.5 X 56.5 cm; 60 pcs/carton; gw/nw: 16.4 kg/carton

READY STOCK



- > Ladies Special
- > Keychain
- > Manicure Set

### GSBG 915 - MANIKE

Gift set consisting of a manicure set and a keychain. Manicure set consists of Nail filer, Cuticlepusher, Nail clipper and toe nail Clipper. Packed in a nice gift box.

(Box) Print Technique : SC, UV      Preferred Print Location : Front Plate  
Max Print Size : 35 x 10 mm

(Keychain) Print Technique : SC, UV, ENG      Preferred Print Location : Front  
Max Print Size : 30 x 30 mm

(Manicure Set) Print Technique : SC, UV, ENG      Preferred Print Location : Front  
Max Print Size : 90 x 40 mm

Product Box Size : 14 x 16 x 3 cm

Packing Details : 34 X 29 X 38.5cm; 40 pcs/carton; gw/nw: 10.3 kg/carton



- > Genuine Leather Men's Wallet
- > Keyring
- > Value Deal !!

### GSGL 490 - JARMEN

Set of wallet and Keychain. Packed in a gift box.

(Box) Print Technique : SC, UV      Preferred Print Location : Front Center  
Max Print Size: 150 x 140 mm

(Wallet) Print Technique : ENG, UV, FO      Preferred Print Location : Front Bottom Right  
Max Print Size : 90 x 70 mm

(Keychain) Print Technique : ENG, SC, UV      Preferred Print Location : Front  
Max Print Size : 25 x 15 mm

Product Box Size : 15 x 14 x 2.5 cm



**GSGL 492 - TACNA**

Giftology Set of Notebook and Digital Luggage Scale

(Notebook) Print T : UV, SC	Print L : Front	Max Print Size : 120 x 190 mm
(Luggage Scale) Print T : UV, SC	Print L : Front	Max Print Size : 15 x 20 mm
(Box) Print T : UV, SC	Print L : Top of Box	Max Print Size : 180 x 220 mm
Product Box Size : 3.7 X 19.6 X 23.2 cm		



**GSGL 495 - NAZCA**

Giftology Set of Wallet and Metal Pen

(Box) Print T : UV, SC	Print L : Top of Box	Max Print Size : 130 x 200 mm
(Wallet) Print T : UV, SC	Print L : Front Bottom	Max Print Size : 85 x 60 mm
(Pen) Print T : UV, SC	Print L : Next to Clip	Max Print Size : 25 x 5 mm
Product Box Size : 3.4 X 15 X 21 cm		

**READY STOCK**



**GSGL 491 - CUSCO**

Giftology Set of Wireless Charger and TSA Lock

(Box) Print T : UV, SC	Print L : Top of Box	Max Print Size : 80 x 160 mm
(Charger) Print T : UV, SC	Print L : Top of Charger	Max Print Size : 100 x 60 mm
(Lock) Print T : UV, SC	Print L : Front	Max Print Size : 7 x 10 mm
Product Box Size : 3.3 X 9.7 X 17.7 cm		



**GSGL 496 - VIRU**

Giftology Set of Powerbank, Keyring and Metal Pen

(Box) Print T : UV, SC	Print L : Top of Box	Max Print Size : 130 x 200 mm
(Powerbank) Print T : UV, SC	Print L : Cover	Max Print Size : 135 x 92 mm
(Pen) Print T : UV, SC	Print L : Next to Clip	Max Print Size : 25 x 5 mm
(Keychain) Print T : UV, SC	Print L : Front	Max Print Size : 30 x 6 mm
Product Box Size : 3.4 X 15 X 21 cm		



## PERSONALIZATION

Add a touch of distinction to your bag with TUMI's personalization services and products.

### MONOGRAMMING

Personalize your bag with TUMI's hand-stamped artisan craftsmanship monogramming, complimentary for travel and business products that feature an exterior leather monogram patch or TUMI luggage tags. A variety of styles and colors are available to suit any distinguished traveler. Have your design, logo or initials carefully debossed into the material to add a personal and permanent touch to your TUMI product. Hotstamp your monogram with a brilliant metallic gold or silver print that outshines any ink design for an eye-catching personalization.



This catalog includes highlights of TUMI's best-selling product offerings for men and women, the perfect selection of gifting options for any occasion.



# TUMI EXCLUSIVE INNOVATIONS



## FXT BALLISTIC NYLON®

Our exclusive FXT ballistic fabric combines a unique weave and special coating to make it ultra-durable.



## TEGRIS®

Globally exclusive to TUMI, Tegris offers unparalleled strength and impact resistance at very light weights.

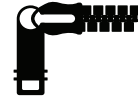

## OMEGA CLOSURE SYSTEM®

Our patented system reduces the risk of damage to the zipper and makes replacing one unnecessary.



## X-BRACE 45® HANDLE SYSTEM

An innovative telescoping handle made from lightweight-yet-sturdy aircraft-grade aluminum.



## TUMI TRACER®

A complimentary program that reunites TUMI customers with their lost or stolen bags.



## LEVER LOCK™

A two-stage expansion system that offers up to 2.5 extra inches of packing space.



## DURAFOLD™

This construction method reinforces the corners of hardside cases with heavy-duty stitching and impact-resistance caps.



## SECURE SLIDE® SHOULDER STRAP ATTACHMENT

This exclusive design features a cover that slides into place to ensure the clip stays securely closed.



## T-PASS®

Breeze through airport security hassle-free with computer cases and sleeves designed to meet the Transportation Security Administration's technical requirements.



## ADD-A-BAG SYSTEM

Secure another travel or business bag to another with the patented Add-A-Bag hook to effortlessly carry multiple items at the same time.



## ID LOCK™

RFID-blocking ID Lock™ technology protects personal information on credit cards and documents from identity theft by electronic data reading devices.



## RECESSED DUAL WHEELS

Offering better balance and smoother rolling, recessed dual wheels streamline the travel experience while maximizing internal packing capacity.



TUMI Alpha SLG - Double Billfold Wallet - Black Chrome



TUMI Alpha SLG - Double Billfold Wallet - Black / Red

2 options of the elegant TUMI logo  
**MATM 734** - Tumi Alpha SLG Wallet - Black Chrome  
Print Technique : EMB, ENG  
Product Size: 11.5 X 8 cm

Preferred Print Location : Inside

**MATM 735** - TUMI Alpha SLG Wallet - Black / Red  
Max Print Size : 50 x 10 mm or 25 X 25 mm

READY STOCK



TUMI Alpha SLG - Passport Case - Black Chrome

**TATM 736** - TUMI Alpha SLG - Passport Holder - Black Chrome  
Print Technique : EMB, ENG  
Product Size: 14.5 x 12 cm

Preferred Print Location : Inside Right

Max Print Size : 50 x 10 mm or 25 X 25 mm



READY STOCK



**SBTM 733** - TUMI Alpha 3 Pocket Shoulder Bag  
 Print Technique : ENG on Front Patch    Max Print Size : 35 x 15 mm  
 Print Technique : SC on Front            Max Print Size : 120 x 70 mm  
 Product Size: 24 x 20 cm



READY STOCK



**BPTM 732**

TUMI® Alpha Bravo Core Collection - Davis Backpack

A versatile and sleek backpack is made from our highly durable Ballistic Nylon fabric and features a comfortable, adjustable shoulder strap and precisely designed compartments for your laptop, tablet and other daily essentials. Perfect commuter bag or as a carry-on.

Print Technique : ENG on Front Patch

Max Print Size : 35 x 15 mm

Print Technique : SC on Front

Max Print Size : 200 x 110 mm

Product Size : 42 x 29 cm



READY STOCK



**MBTM 731**

TUMI® Alpha Bravo Core Collection - Aviano Slim Brief

From the TUMI Alpha Bravo collection of modern, unstructured day and travel bags comes this commuter-ready brief crafted in an exceedingly durable Ballistic fabric. Slim and well organized, it offers dedicated laptop and iPad compartments, numerous interior and exterior pockets and a removable shoulder strap.

Print Technique : ENG on Front Patch

Max Print Size : 35 x 15 mm

Print Technique : SC on Front

Max Print Size : 60 x 160 mm

Product Size: 40 x 30 cm

# Genuine Leather Accessories from SANTHOME

Scan this QR code to learn  
more about the Anti-Microbial  
effectiveness and check  
certifications



Scan this QR code to see how  
Biomaster works on the surface  
of the product to effectively  
protect you 24/7





**SANTHOME**  
GENUINE LEATHER



Leather Article contains Biomaster antimicrobial technology that provides protection against the growth of harmful micro-organisms for the lifetime of the product. A special tracker is built into the product to prove that the surface is treated with Biomaster. Packed in Santhome gift box.

**SANTHOME**  
GENUINE LEATHER



READY STOCK



**LASN 658 BIO - TORREON**

**SANTHOME PROTECT** Providing a safe and convenient way to carry all of your travel documents in one place, this wallet will organise even the most chaotic traveller. Ideal for storing passports, tickets and credit cards, 8 well-proportioned compartments offer quick and easy access to all your travel essentials for a smoother journey. This product contains Biomaster antimicrobial technology that provides protection against the growth of harmful micro-organisms for the lifetime of the product. A special tracker is built into the product to prove that the surface is treated with Biomaster. Packed in a Santhome gift box.

Print Technique : FO, EMB, ENG Preferred Print Location : Front  
Max Print Size : 80 x 50 mm Product Size : 20 x 11 x 1.5 cm

**GSSN 186 BIO - TONALA**

**SANTHOME PROTECT** Set includes Genuine Leather Travel Wallet and complimenting Metal Pen. Interior organization includes a passport holder, ID holder, three business or credit card pockets and boarding document holder. The travel wallet contains Biomaster antimicrobial technology that provides protection against the growth of harmful micro-organisms for the lifetime of the product. A special tracker is built into the product to prove that the surface is treated with Biomaster. Pen is also treated for antimicrobial effectiveness. Packed in a Gift Box.

(Wallet) Print Technique : FO, EMB, ENG Preferred Print Location : Front  
Max Print Size : 80 x 50 mm  
(Pen) Print Technique : UV, SC Preferred Print Location : Barrel  
Max Print Size : 6 x 40 mm



ANTI-MICROBIAL  
GENUINE LEATHER MEN'S WALLETS

SANTHOME  
PROTECT

SANTHOME  
GENUINE LEATHER



**LASN 652 BIO - CANCUN**  
SANTHOME PROTECT Genuine Leather Men's wallet with contrast grey stitching. The inside of the wallet features 3 card slots, 2 section for banknotes and 1 coin pocket.

SANTHOME  
GENUINE LEATHER



**LASN 651 BIO - MERIDA**  
SANTHOME PROTECT Genuine Leather Men's wallet with contrast grey stitching. The inside of the wallet features 6 card slots, 2 section for banknotes and 2 additional pockets for receipts and appointment cards.

READY STOCK

SANTHOME  
GENUINE LEATHER

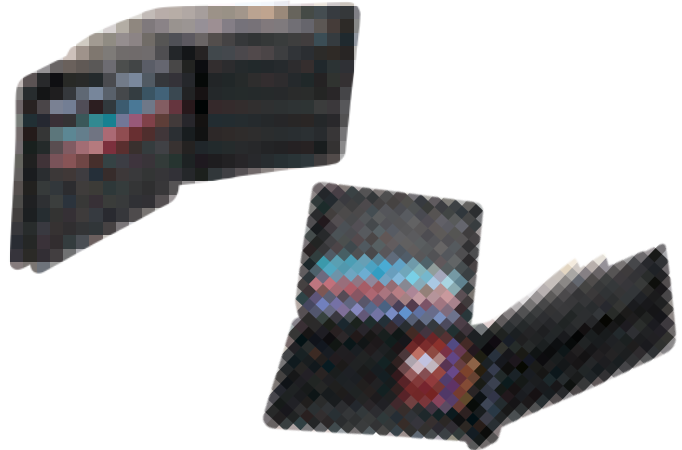

**LASN 656 BIO - TOLUCA**  
SANTHOME PROTECT Exclusive wallet with numerous compartments to keep everything you need together and organized. The wallet itself has a stylish and sophisticated look for any occasion. Consists of 2 bill compartment, 9 card slots along and compartment for coins.

Print Technique : ENG, EMB, FO Preferred Print Location : Front  
Max Print Size : 85 X 60 mm Product Size : 9 X 11.5 X 1.5 cm



Above Leather Articles contain Biomaster antimicrobial technology that provides protection against the growth of harmful micro-organisms for the lifetime of the product. A special tracker is built into the product to prove that the surface is treated with Biomaster. Packed in Santhome gift box.







- Genuine Leather Men's Wallet
- 13 Credit Card Pockets
- Elegant Contrast Stitching

SANTHOME  
GENUINE LEATHER



**LASN 653 BIO - MORELIA**

SANTHOME GENUINE LEATHER Men's wallet with attractive contrast grey stitching. The inside of the wallet features 11 card slots, 1 big section for banknotes and 2 additional pockets for receipts and appointment cards.

Print Technique : EMB, FO, ENG Preferred Print Location : Bottom Center  
Max Print Size : 85 x 60mm Product Size : 10.5 x 14.5 x 2.5 cm

SANTHOME  
GENUINE LEATHER



**LASN 666 BIO - TEPIC**

SANTHOME GENUINE LEATHER Impressive genuine leather card holder with contrast grey stitching. It contains essential pockets to carry your cards & bank notes. Inside has 4 credit card / business card pockets and 1 currency compartment. There are 3 additional quick access card pockets in the back.

Print Technique : EMB, FO, ENG Pre. Print Location : Front  
Max Print Size : 55 x 70 mm Product Size : 10.5 x 7.5 x 1 cm

SANTHOME  
GENUINE LEATHER



**LASN 655 BIO - CHALCO**

SANTHOME GENUINE LEATHER Genuine leather card case with attractive contrast grey stitching. Flip open to find the main section of card holder which can store up to 40 Business cards. An additional pocket on the other side to store credit card or ID card comes with a small window.

Print Technique : ENG, EMB, FO Preferred Print Location : Front Bottom  
Max Print Size : 50 x 70 mm Product Size : 10.5 x 7.8 x 1.5 cm

READY STOCK



Above Leather Articles contain Biomaster antimicrobial technology that provides protection against the growth of harmful micro-organisms for the lifetime of the product. A special tracker is built into the product to prove that the surface is treated with Biomaster. Packed in Santhome gift box.





GENUINE LEATHER ANTIMICROBIAL GIFT SETS

SANTHOME PROTECT

SANTHOME GENUINE LEATHER



SANTHOME GENUINE LEATHER



READY STOCK

GSSN 498 BIO - HAIGER

SANTHOME PROTECT Gift set consisting of wallet, cardholder both made from genuine grained leather, and metal pen. The Wallet and Cardholder contain Biomaster antimicrobial technology that provides protection against the growth of harmful micro-organisms for the lifetime of the product. A special tracker is built into the product to prove that the surface is treated with Biomaster. Pen is also treated for antimicrobial effectiveness. Packed in a Gift Box.

(Card Holder) Print Technique : EMB, FO, ENG	Pre. Print Location : Front
Max Print Size : 55 x 70 mm	
(Wallet) Print Technique : EMB, FO, ENG	Pre. Print Location : Bottom
Max Print Size : 85 x 60 mm	
(Pen) Print Technique : SC, UV, ENG	Pre. Print Location : Barrel
Max Print Size : 7 x 70 mm	

GSSN 497 BIO - KLEVE

SANTHOME PROTECT Gift set consisting of wallet, cardholder both made from genuine grained leather, and metal pen. The Wallet and Cardholder contain Biomaster antimicrobial technology that provides protection against the growth of harmful micro-organisms for the lifetime of the product. A special tracker is built into the product to prove that the surface is treated with Biomaster. Pen is also treated for antimicrobial effectiveness. Packed in a Gift Box.

(Card Holder) Print Technique : EMB, FO, ENG	Pre. Print Location : Front
Max Print Size : 55 x 70 mm	
(Wallet) Print Technique : EMB, FO, ENG	Pre. Print Location : Bottom
Max Print Size : 85 x 60 mm	
(Pen) Print Technique : UV, SC	Pre. Print Location : Barrel
Max Print Size : 7 x 70 mm	



Above Leather Articles contain Biomaster antimicrobial technology that provides protection against the growth of harmful micro-organisms for the lifetime of the product. A special tracker is built into the product to prove that the surface is treated with Biomaster. Packed in Santhome gift box.





### SANTHOME GENUINE LEATHER



LASN 659 - RANSOL

**SANTHOME** Tall, slim and highly elegant, Ransol is a leather coat wallet that is a perfect option to use with a suit. Tucked inside the breast pocket, it will not break the line of the suit while still carry 14 credit cards and keep all your banknotes crisp and neat in 3 slip-in pockets.

Print Technique : FO, EMB, ENG Preferred Print Location : Front  
Max Print Size : 80 x 50 mm Product Size : 20 x 11 x 1 cm

### SANTHOME GENUINE LEATHER



LASN 668 - POMPEII

**SANTHOME** Have all your travel essentials at one place in this Genuine Leather travel wallet which can store ample of essentials in an organized manner. Have a safe and worry free travel. Pockets inside for Bank notes, currencies, coins & 5 credit cards. Packed in a Santhome gift box.

Print Technique : EMB, FO, ENG Pre. Print Location : Bottom Center  
Max Print Size : 80 x 50 mm Product Size : 20 x 11 x 1.5 cm

### SANTHOME GENUINE LEATHER



- > Genuine Leather Men's Wallet
- > 14 Credit Card Pockets
- > Elegant Contrast Stitching



LASN 654 - TRENTO

**SANTHOME** Genuine Leather Men's wallet with attractive contrast grey stitching. The inside of the wallet features impressive 14 credit card pockets which has 6 slots as easy access & 8 slots are buttoned inside to keep your cards safe. In addition there are 2 sections to keep your bank notes.

Print Technique : ENG, EMB, FO Preferred Print Location : Front Bottom Center  
Max Print Size : 65 x 40mm Product Size : 12 x 9 x 1.5cm

### SANTHOME GENUINE LEATHER



LASN 667 - BARI

**SANTHOME** Genuine Leather Passport cover with contrast grey stitch and button closure. This passport holder has 8 credit card pockets, a currency compartment and space to hold 2 passports. Packed in Santhome gift box.

Print Technique : EMB, FO, ENG Pre. Print Location : Bottom Center  
Max Print Size : 85 x 50 mm Product Size : 15 x 11 x 1 cm

READY STOCK



SANTHOME  
GENUINE LEATHER



READY STOCK



**GSSN 184 - OLFUS**

SANTHOME Olfus gift set consisting of a genuine leather passport holder and a matt finish metal pen. Packed in a gift box.

(Passport Holder) Print Technique : EMB, FO, ENG

Pre. Print Location : Bottom Center

Max Print Size : 85 x 50 mm

(Pen) Print Technique : UV, SC

Pre. Print Location : Barrel

Max Print Size : 7 x 70 mm

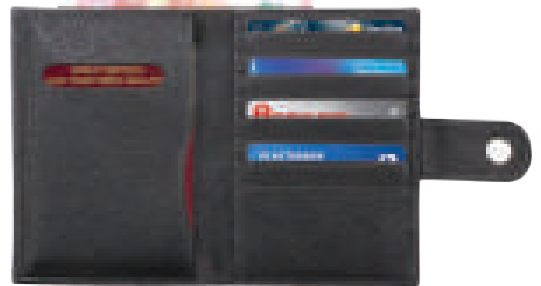

**GSSN 182 - AKRANES**

SANTHOME Akranes is a gift set consisting of genuine leather Passport holder, genuine leather Wallet and a metal pen. Packed in a nice gift box.

(Passport Holder) Print Technique : EMB, FO, ENG

Pre. Print Location : Bottom Center

Max Print Size : 85 x 50 mm

(Wallet) Print Technique : EMB, FO, ENG

Pre. Print Location : Bottom

Max Print Size : 85 x 60 mm

(Pen) Print Technique : UV, SC, ENG

Pre. Print Location : Barrel

Max Print Size : 7 x 70 mm



**LAGL 011 - RHINOW**

(Wallet) Print Technique : FO, SC, EMB  
 (Card Holder) Print Technique : FO, SC, EMB  
 Product size : (Wallet) 11 X 9 cm (Card Holder) 9.5 X 7.5 cm

Preferred Print Location : Front Centre Bottom on Wallet  
 Preferred Print Location : Front of Cards holder  
 Packing Details : 74 X 51 X 31 cm ; 100 pcs /carton ; gw/nw: 19/18 kg / carton

Max Print Size : 60 X 60 mm  
 Max Print Size : 30 X 70 mm



READY STOCK



**LAGL 013 - TRIPTIS**

Print Technique : FO, EMB, SC  
 Product size : 11 X 9 cm

Preferred Print Location : Front Bottom  
 Max Print Size : 50 X 50 mm  
 Packing Details : 61 X 51 X 25 cm ; 60 pcs /carton ; gw/nw: 17/16 kg / carton



**LAGL 004 - LINKUVA**

Giftology Genuine Leather Men's Mini Over-flap bifold wallet with space to keep all your pocket essentials. Features 9 Credit Card Pockets, 1 ID Pocket, 2 Slip in Pockets and a large bill compartment. Also features an ID pocket on the outside for easy access. Packed in a gift box.

Print Technique : FO, EMB, ENG, SC  
 Product size : 7.9 X 11 X 2 cm

Preferred Print Location : Front Bottom  
 Max Print Size : 50 X 75 mm  
 Packing Details : 56 X 30 X 29 cm ; 100 pcs /carton ; gw/nw: 11.1 kg / carton



# GENUINE LEATHER CARD HOLDERS / WALLETS



### LAGL 002 - SILUTE

Giftology Basic Genuine Leather Men's bifold wallet featuring 4 Credit Card Pockets, 1 ID Card Pocket, 2 Slip in Pockets and a large bill compartment with bill divider where you can keep your bills safe and organized. Packed in a Gift Box.

Print Technique : FO, EMB, ENG, SC

Preferred Print Location : Front Bottom

Max Print Size : 85 X 60 mm

Product size : 9 X 11.5 X 1 cm

Packing Details : 56 X 30 X 29 cm ; 100 pcs /carton ; gw/nw: 10.4 kg / carton

READY STOCK



### LAGL 003 - SEDUVA

Giftology Roomy yet slim genuine leather men's wallet with center-flap. Features 12 Credit Card Pockets, 1 ID Pocket, 4 Slip in Pockets and a large bill compartment with a bill divider where you can keep your bills safe and organized. Packed in a Gift box.

Print Technique : FO, EMB, ENG, SC

Preferred Print Location : Front Bottom

Max Print Size : 85 X 60 mm

Product size : 9 X 11.5 X 1.5 cm

Packing Details : 56 X 30 X 29 cm ; 100 pcs /carton ; gw/nw: 12.3 kg / carton

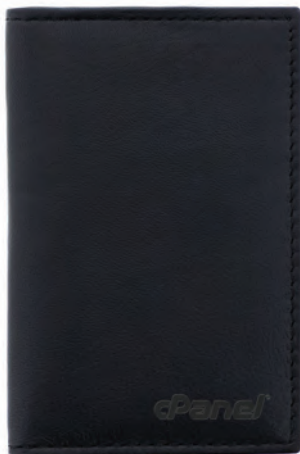

### LAGL 009 - VIEVIS

Giftology Basic Genuine Leather Card holder with 6 credit card pockets and 2 slip in pockets. Packed in a gift box.

Print Technique : FO, EMB, ENG, SC

Preferred Print Location : Front Bottom

Max Print Size : 55 X 80 mm

Product size : 11.5 X 7.5 X 1.2 cm

Packing Details : 47 X 29 X 26 cm ; 100 pcs /carton ; gw/nw: 7.9 kg / carton



LAGL014 - WELZOW

Giftology Basic genuine leather Passport cover packed in a gift box

Print Technique : FO, EMB, SC Preferred Print Location : Front Max Print Size : 70 X 80 mm  
 Product size : 14.5 X 10 cm Packing Details : 53 X 52 X 28 cm ; 60 pcs /carton ; gw/nw: 15.5/14.5 kg / carton



LAGL001 - JONAVA

Giftology Elegant multi pocket genuine leather cheque book holder with button closure. Consists of 5 credit card slots and an ID pocket. Carry all your important documents such as cheque book, cards and other travel document conveniently with this thoughtfully designed wallet.

Print Technique : FO, EMB, ENG, SC Preferred Print Location : Front Bottom Max Print Size : 70 X 80 mm  
 Product size : 21.5 X 11.7 X 1.3 cm Packing Details : 69 X 47 X 27 cm ; 100 pcs /carton ; gw/nw: 18.7 kg / carton

READY STOCK



LAGL008 - PALANGA

Giftology A useful Genuine Leather Card Holder with button closure for the modern man. Features 6 Credit Card Pockets, 2 Slip in Pockets and a Zipper Pocket to keep coins, keys etc. Also features an ID pocket on the outside for easy access. Packed in a gift box.

Print Technique : FO, EMB, ENG, SC Preferred Print Location : Front Bottom Max Print Size : 55 X 75 mm  
 Product size : 10 X 7.5 X 1.2 cm Packing Details : 47 X 29 X 26 cm ; 100 pcs /carton ; gw/nw: 8.3kg / carton



**GSGL 007 - TAURAGE**

Giftology Gift set for men consisting of genuine leather wallet and card holder. These classic accessories for everyday use are simple yet essential. Packed in a gift box.

(Wallet) Print Technique : FO, EMB, ENG, SC

Preferred Print Location : Front Bottom

Max Print Size : 85 X 60 mm

(Card Holder) Print Technique : FO, EMB, ENG, SC

Preferred Print Location : Front Bottom

Max Print Size : 55 X 80 mm

Product Box Size : 22.5 X 12.7 X 2.5 cm

Packing Details : 48 X 30 X 36 cm ; 100 pcs /carton ; gw/nw: 20.5 kg / carton

READY STOCK



Elegant Cotton Pouch



- > Toiletries Pouch / Wash bag for organizing your travel
- > Zipper Pockets in front, at the back & on top
- > Spacious interior

**LAGL 019 - GUBEN**

Giftology Each leather wash bag in an elegant natural cotton drawstring pouch.

(Toiletry Pouch) Print Technique : FO, EMB, SC

Preferred Print Location : Front

Max Print Size : 40 X 50 mm

(Cotton Pouch) Print Technique : SC

Preferred Print Location : Front

Max Print Size : 150 X 300 mm

Product size : 25 X 10 X 13 cm

Packing Details : 61 X 56 X 46 cm ; 24 pcs /carton ; gw/nw: 13/12 kg / carton





- 3 Zipper pockets in the front
- 1 Zipper pocket in the back of pouch
- Adjustable strap makes for convenient strap-on
- Travel hands-free, safe & secure
- Large size for securing family belongings



**LAGL 017 - FREITAL**

(Waist Pouch) Print Technique : FO, EMB, SC  
Product size : 34 X 18 cm

Preferred Print Location : Front      Max Print Size : 30 x50mm  
Packing Details : 51 X 51 X 30 cm ; 50 pcs /carton ; gw/nw: 12.7/11.5 kg / carton

READY STOCK

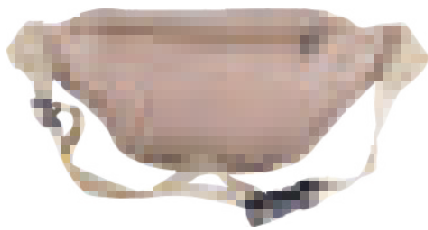

- 3 Zipper pockets in the front
- 1 Zipper pocket in the back of pouch
- Cow milled Nappa Leather- elegant beige / camel natural color
- Adjustable strap makes for convenient strap-on
- Travel hands-free, safe & secure
- Large size for securing family belongings
- Packed in cotton drawstring pouch

Elegant Cotton Pouch



**LAGL 018 - GRANSEE**

(Waist Pouch) Print Technique :FO, EMB, SC  
(Cotton Pouch) Print Technique : SC  
Product size : 34 X 17 cm

Preferred Print Location : Front      Max Print Size : 30 x50mm  
Preferred Print Location : Front      Max Print Size : 170 xmm  
Packing Details : 51 X 51 X 30 cm ; 50 pcs /carton ; gw/nw: 12.7/11.5 kg / carton



**GSGL 493 - TUMBES**

Giftology Set of Genuine Leather Card Wallet, Flashlight Keyring and Metal Pen

(Wallet) Print Technique : FO, EMB, ENG, SC

(Flashlight Keyring) Print Technique : SC, ENG

(Metal Pen) Print Technique : UV, SC

Product Box Size : 3.4 X 15 X 21 cm

Preferred Print Location : Front Bottom

Preferred Print Location : Body of the Flashlight

Preferred Print Location : Next to Clip

Max Print Size : 85 X 60 mm

Max Print Size : 20 X 6 mm

Max Print Size : 25 X 5 mm

READY STOCK



**GSGL 494 - LAREDO**

Giftology Set of Genuine Leather Card Holder, Flashlight Keyring and Metal Pen

(Card Holder) Print Technique : FO, EMB, ENG, SC

(Flashlight Keyring) Print Technique : SC, ENG

(Metal Pen) Print Technique : UV, SC

Product Box Size : 3.4 X 15 X 21 cm

Preferred Print Location : Front Bottom

Preferred Print Location : Body of the Flashlight

Preferred Print Location : Next to Clip

Max Print Size : 55 X 80 mm

Max Print Size : 20 X 6 mm

Max Print Size : 25 X 5 mm

## CROSS - The Iconic Brand

The iconic writing instruments brand established in the United States in 1846. Famed as the brand used by American Presidents, Cross Leather Accessories have been extremely successful and the award-winning leather accessories collection is currently being retailed in over 40 countries across the globe. Over a short span, the leather accessories under CROSS's banner has managed to gather a lot of fame with two consecutive wins in Germany this year at the Red Dot Design Awards and ILM Offenbach Awards. CROSS products form an excellent gifting option.

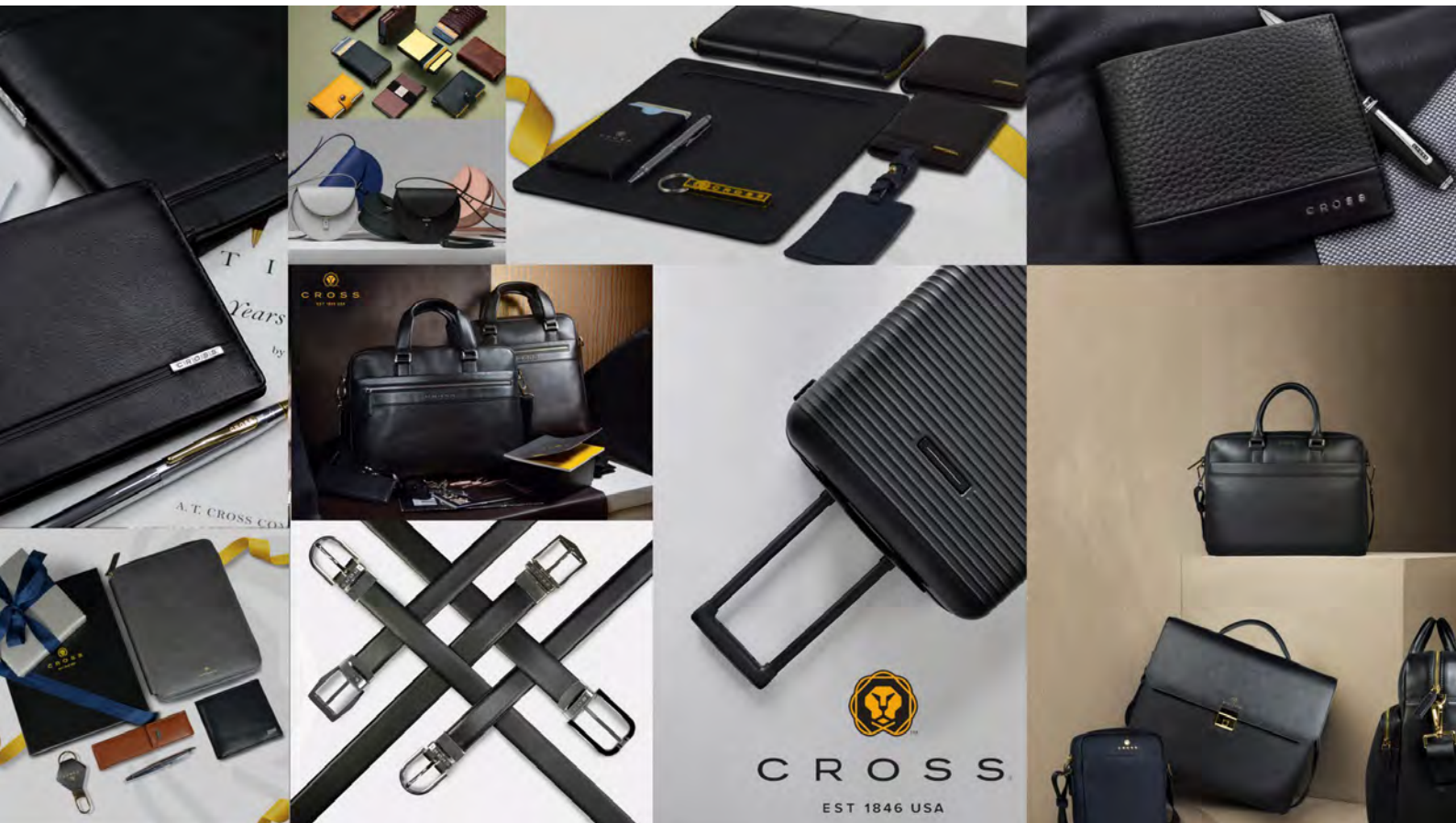



READY STOCK



**LACRS 885 - CHESTER**  
Authentic Cross Branded wallet made with 100% Genuine Leather. Includes 4 Credit Card Slots, 2 Multi-purpose slip-in Pockets, 2 Currency Compartment and 1 Coin Pocket.  
Print Technique : ENG, EMB Preferred Print Location : Inside Right Bottom  
Max Print Size : 12 x 30 mm Product Size: 9 x 11 cm

**LACRS 886 - ELY**  
Authentic Cross Branded wallet made with 100% Genuine Leather. Includes 8 Credit Card Pockets, 2 Currency Compartment and 2 Multi-Purpose Pockets.  
Print Technique : ENG, EMB Preferred Print Location : Inside Right Bottom  
Max Print Size : 25 x 50 mm Product Size: Product Size: 9 x 11 cm



- Holds Business Cards, ID Cards, Credit Cards
- Can hold folded currency notes
- Genuine Leather

**LACRS 890 - ALZEY**

Business and Credit Card Case Wallet

Print Technique : ENG, EMB Preferred Print Location : Inside  
Max Print Size : 30 x 30 mm Product Size: 10.5 x 7.5 cm



- Genuine Leather
- Sleek & Elegant
- Holds Credit Cards

**LACRS 891 - HOYA**

HOYA Credit Card Case Wallet

Print Technique : ENG, EMB Preferred Print Location : Front  
Max Print Size : 30 x 20 mm Product Size: 9.6 x 8.2 cm

READY STOCK



# CROSS GENUINE LEATHER PASSPORT HOLDER



READY STOCK



- > Genuine Leather
- > Holds Passport & Credit cards
- > Pen slot discreetly holds pen
- > Separate pocket can hold Boarding pass, Currency, Misc Documents
- > An ideal travel companion from the renowned brand CROSS.

LACRS 892 - BARTH

International Passport Wallet  
Print Technique : ENG, EMB  
Product Size: 10 x 1 x 13.3 cm

Preferred Print Location : Inside

Max Print Size : 50 x 20 mm



- A5-most handy & appropriate size
- Hard Elegant gift box
- Credit card & Documents compartment
- Replacable Notebook
- Your prime meetings Accessory

READY STOCK

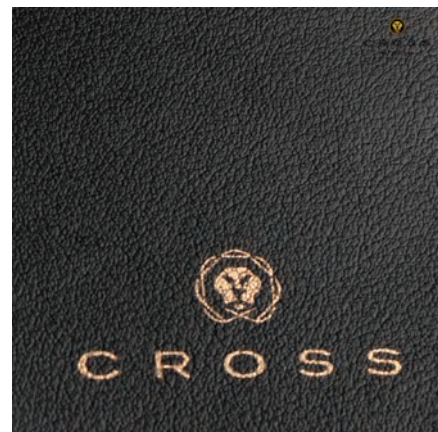

**Genuine Leather**

LACRS 889 - FURTH  
A5 Size Planner Cover  
Print Technique : ENG, EMB  
Product Size: 23.3 x 17.3 cm

Preferred Print Location : Inside

Max Print Size : 50 x 20 mm



# GENUINE LEATHER LAMBORGHINI & SANTHOME



by *Tonino Lamborghini*



98204-10 - LERICI  
*Tonino Lamborghini* Card holder in black full grain leather



by *Tonino Lamborghini*



98187-10 - MARINDI  
*Tonino Lamborghini* Cards + Key holder in black top quality leather



by *Tonino Lamborghini*



98201-10 - CECILIA  
*Tonino Lamborghini* Ladies wallet in black top quality Genuine Leather

## SANTHOME GENUINE LEATHER



LASN 619 - POJ  
**SANTHOME** Genuine Leather classic wallet with blue contrast stitching. The subtle and fine-detailing and the practical card-holder compartments underline the masculine and practical appeal of this wallet. Packed in a Santhome gift box.  
Print Technique : Eng, Emb, FO Preferred Print Location : Front Bottom Center  
Max Print Size : 65 x 40 mm Product Size : 12 x 9 x 1.5 cm  
Packing Details ( Without Box ) : 41 x 21 x 53 cms ; 150 pcs /carton ; gw/nw: 11.2 kg / carton

READY STOCK





Genuine Leather

Pierre Cardin  
PARIS



FEATURES :

- > Genuine soft leather cardholder
- > Contrast grey stitch
- > With modern PIERRE CARDIN pen
- > Pocket to keep currency
- > LED lights to display available power



LAPC 761 -LOUVRE

( Card Holder) Print Technique : SC, EMB, ENG Preferred Print Location : Max Print Size : 20 x 30mm  
 ( Pen) Print Technique : UV, ENG Preferred Print Location : Max Print Size :  
 Product Size : 11.2 x 8 x 0.4cm Packing Details : 63 x 32.5 x 25cm ; 100 pcs /carton ; gw/nw: 9.8 kg / carton



Brown



Black



SANTHOME  
MADE IN GERMANY



READY STOCK



6301 - FLUGHAFEN

Print Technique : FO, ENG, EMB  
 Preferred Print Location : Front Bottom Right  
 Max Print Size : 95 x 205 mm

Genuine Leather.  
 Article crafted & made in Germany.  
 A Travel wallet - elegant & practical



SANTHOME  
MADE IN GERMANY



6901 - MUNCHEN

Print Technique : ENG, FO, EMB  
 Preferred Print Location : Front Bottom Center  
 Max Print Size : 50 x 100 mm  
 Product Size : 7.5 x 12 x 1.7 cm

Genuine Leather.  
 Article crafted & made in Germany.  
 A mobile phone holder designed to hold various currently used mobile phone instruments.



# NOTEPAD WALLETS

Pierre Cardin  
PARIS

Genuine Leather

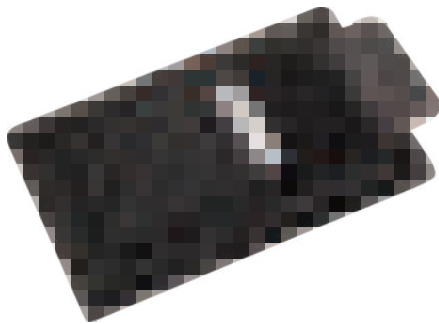
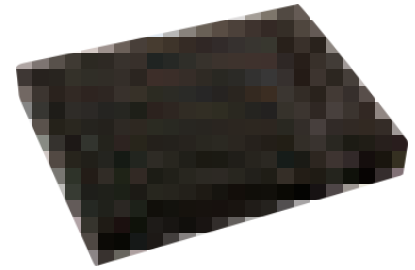

### FEATURES :

- Genuine soft leather cardholder
- Contrast grey stitch
- With modern PIERRE CARDIN pen
- Phone pocket on the back
- Pockets to keep cards
- PIERRE CARDIN branded plain papers included



LAPC 763 - TILAT

( Card Holder) Print Technique : SC, EMB, ENG  
( Pen) Print Technique : UV, ENG

Product Size: 18 x 10.7 x 1.6 cm

Preferred Print Location : Front  
Preferred Print Location :

Packing Details : 78x 24 x 27.5cm ; 50 pcs/carton ; gw/nw: 13.5 kg / carton

Max Print Size : 30 x 50mm  
Max Print Size :

READY STOCK

## GENUINE LEATHER

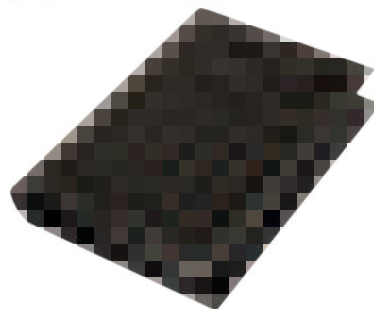

### FEATURES :

- Genuine soft leather cardholder
- Contrast grey stitch
- With modern PIERRE CARDIN pen
- Pockets to keep credit cards, sim cards
- PIERRE CARDIN branded plain papers included



LAPC 762 - MARAIS

( Card Holder) Print Technique : SC, EMB, ENG Preferred Print Location : Max Print Size : 20 x 30mm

( Pen) Print Technique : UV, ENG Preferred Print Location : Max Print Size : Product Size : 14 x 9 x 1.6cm

Packing Details : 69 x 38 x 25cm ; 100 pcs/carton ; gw/nw: 17.5 kg / carton

For consumption in selected East & West African countries

MOLESKINE®

*Craftsmanship*





Genuine Leather



READY STOCK

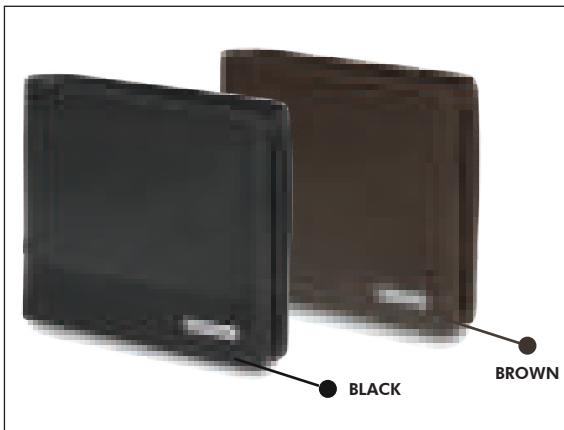

LAMOL 103 - Black LAMOL 104 - Brown

MOLESKINE This classic yet contemporary horizontal wallet features an unexpected match of two different types of leather – one smooth to the touch and the other textured and tactile. With plenty of space for both cards, cash and keepsakes, the smart Classic Match Horizontal Wallet with coin pocket moves effortlessly with you from elegant to everyday. Any variations in the appearance of the leather between one wallet and the next make you as unique as the combination of items you store inside.

Print Technique : EMB, FO, ENG Preferred Print Location : Inside Max Print Size : 85 x40mm  
Product size : 12 x 9.5x 1.5cm Packing Details : 26 x 18 x 16cm ; 8 pcs /carton ; gw/nw: 1.8 kg / carton



Genuine Leather



READY STOCK



LAMOL 105

MOLESKINE This classic yet contemporary black horizontal wallet features an unexpected match of two different types of leather – one smooth to the touch and the other textured and tactile. With plenty of space for both cards, cash and keepsakes, the smart Classic Match Horizontal Wallet moves effortlessly with you from elegant to everyday. Any variations in the appearance of the leather between one wallet and the next make yours as unique as the combination of items you store inside.

Print Technique : EMB, FO, ENG  
Product size : 12 x 9.5 x 1.5cm

Preferred Print Location : Inside      Max Print Size : 85 x 40mm  
Packing Details : 26 x 18 x 16cm ; 8 pcs/carton ; gw/nw: 1.8 kg / carton



Genuine Leather



READY STOCK



CODRU

LAMOL 101

The Classic Leather Clip Wallet is made from smooth, premium leather. As well as holding up to 10 cards, tickets, receipts and loose notes, it also features a central hinged metal clip that elegantly holds a number of bank notes in place. Designed to celebrate the clean look, this supple wallet is an elegant travel companion, built to accompany you wherever you go.

Print Technique : EMB, FO, ENG  
Product size : 11 x 9 x 1.5cm

Preferred Print Location : Inside  
Packing Details : 25 x 15 x 14cm ; 8 pcs /carton ; gw/nw: 1.25 kg / carton

Max Print Size : 85 x40mm



Genuine Leather

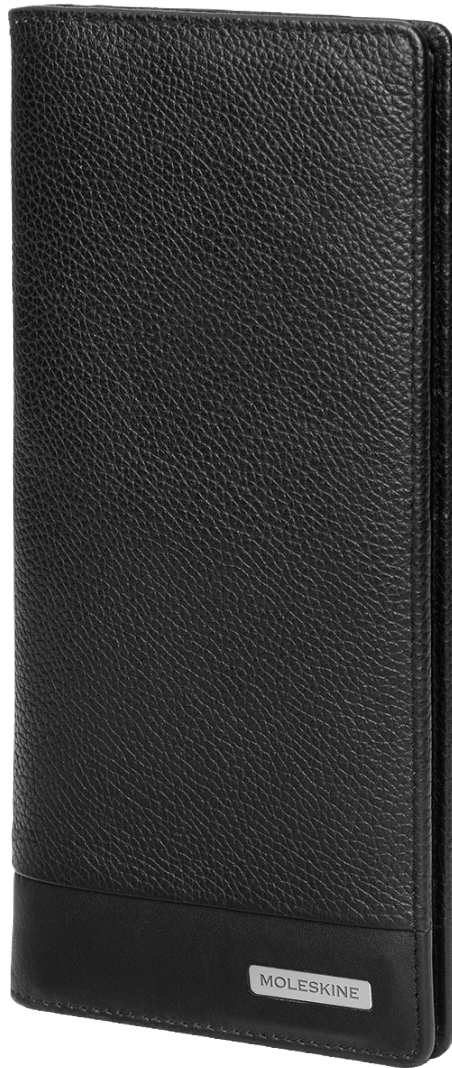

READY STOCK



LAMOL 102

MOLESKINE The black Classic Match Slim fold Wallet is a slim and lightweight wallet that hides huge potential. Made from two types of premium leather - one smooth and the other textured - it has space for up to 15 cards as well as all the notes, tickets, receipts and keepsakes you want to keep safely stored as you move around the city. Any variations in the appearance of the leather between one wallet and the next make yours as unique as the combination of items you carry inside.

Print Technique : EMB, FO, ENG  
Product size : 9 x19 x 2cm

Preferred Print Location : Inside      Max Print Size : 40 x 60mm  
Packing Details : 24 x 19 x 23cm ; 8 pcs /carton ; gw/nw: 2.6 kg / carton



Genuine Leather



READY STOCK

FEATURES:

- Metallic Moleskine logo on front
- Metallic zip puller with logo
- Zip-around entry
- Multiple compartments
- 1 inner coin pocket with zip
- 12 credit card slots



LAMOL 106

MOLESKINE Carry your most precious essentials everywhere and anywhere in a tactile black leather wallet with a secure zip closure.

Print Technique : EMB, FO, ENG

Preferred Print Location : Inside

Max Print Size : 40 x 60mm

Product size : 19.3 x 10.7 x 1.8cm

Packing Details : 30 x 18 x 24cm ; 8 pcs /carton ; gw/nw: 3.7 kg / carton





PRESENTING A WALLET

THAT PROTECTS AGAINST FRAUD IN THE NEW WI-FI ERA.

**RFID**  
**BLOCKING**

**How the card holder protects?**

The aluminium Cardprotector protects your most important plastic cards not only against bending and breaking, but also against malicious parties reading your RFID and NFC cards. RFID (Radio Frequency IDentification) cards contain a chip and an antenna for wireless communication. Examples of RFID cards include the Travel card, ID cards, the latest generation of credit cards and bank cards, as well as various access passes.

**Using the Cardprotector**

The Cardprotector can hold a maximum of 7 cards. If only embossed cards are used, the capacity is 5 cards. Position the cards you use the most at the back or front and they will slide out sufficiently to be used. Slide out the cards with ONE movement of the slider on the side. The radio signal, although still greatly reduced, will now be sufficient for contact over a short distance. This means that you can use your RFID-NFC cards easily and securely. After use, slide your cards back into the Cardholder by pressing down on them lightly.



Scan Below QR code to watch product video



- > Rfid Protection Wallet
- > Slide-Open Mechanism
- > Designed In Europe



**Genuine Italian Leather**



Red

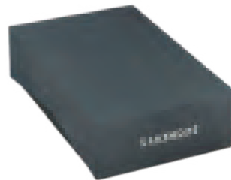

Packaging



White

ITALE

LASN 611 - Red LASN 614 - White

**SANTHOME**

Print Technique : SC, ENG, EMB Preferred Print Location : Front Top Max Print Size : 50 x 50 mm

Product Size : 7 x 10 x 2.5 cm Packing Details : 42.6 x 25.3 x 20.7 cm ; 50 pcs /carton ; gw/nw: 8.1 kg / carton

VITL

LASN 603 - Pink

**SANTHOME** Cardholder cum Wallet with RFID protection . Designed in Europe.

Print Technique : SC, UV, ENG, EMB Preferred Print Location : Front Top Max Print Size : 50 x 50 mm

Product Size : 7 x 10 x 2.5 cm Packing Details : 42.6 x 25.3 x 20.7 cm ; 50 pcs /carton ; gw/nw: 8.5 kg / carton



Pink



Packaging

**PU Leather**

READY STOCK



## LADIES LEATHER GIFTS



by *Tonino Lamborghini*



98201-10 - CECILIA

*Tonino Lamborghini* Ladies wallet in black top quality genuine leather

## SANTHOME GENUINE LEATHER

READY STOCK

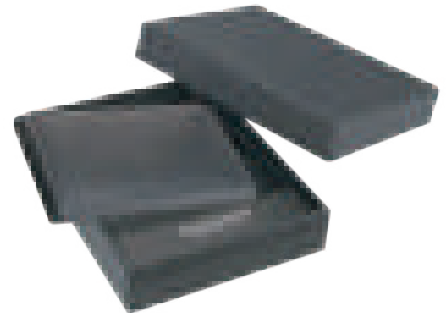

1218 - LOTUP

**SANTHOME** Genuine leather trifold ladies wallet with contrast white stitch. Consists of a coin pocket, a mesh pocket, pockets for credit cards and currency pocket.

Print Technique : ENG, EMB, FO  
Max Print Size : 70 x 95 mm

Preferred Print Location : Bottom Right  
Product Size : 10 x 12 x 2 cm



Maroon



Black



1233 - TYOL

Real Leather Ladies wallet with Zipper Pocket to hold coins, Credit Card pockets and a safe Currency pocket. Its smooth surface adds to its elegance and beauty. Packed in a box.

Print Technique : ENG, EMB, FO  
Max Print Size : 165 x 30 mm

Preferred Print Location : Front Bottom Right  
Product Size : 19 x 10 x 2 cm



Grey

- Anti-Theft
- Cut Proof
- Weight Balance



Light Blue



BOBBY ELLE

BGXD 613 - Grey    BGXD 616 - Light Blue

**XDDDESIGN** The Bobby Elle is not just a fashionable backpack, it also protects you from getting pickpocketed. With hidden zippers there is no way of getting into the backpack while carrying it. However strategically placed hidden pockets on the back of the backpack will give you as user easy access to smaller items when needed. The front of the backpack is protected with a PP board inside which will prevent thieves from cutting through the backpack and reflective strips on the front will ensure your night safety. This backpack will make sure your belongings will stay safe while keeping it fashionable. Registered design®

Print Technique : SC, HT

Preferred Print Location : Front

Max Print Size : 80 x 40 mm

Product Size : 30.5 x 23 x 11 cm

Packing Details : 36 x 57 x 58 cm ; 8 pcs /carton ; gw/nw: 10.01 kg / carton

READY STOCK



TORCY  
WIPP 802-Red



PP 271 - VITAN



TOMOHON  
STMK 149 - Pink



VOGAR  
WIMP 210 - Pink



WIPP 755 - Pink



KUPANG  
STMK 108-Red  
STMK 111- Pink



by *Tonino Lamborghini*



TROPEA-98181-19

*Tonino Lamborghini* Watch with stainless steel case and strap, Mother of Pearl dial, Japan movement.

Packing Size : 11 x 13.5 x 6.5 cm

Packing Details : 47.8 x 40.8 x 50.8 cm

60 pcs /carton ; gw/nw: 16 kg / carton



# XDDESIGN<sup>®</sup> BOPP SPORT WATER BOTTLE



- > 550 ml Capacity
- > Convenient grip, perfect for running
- > Leak proof design

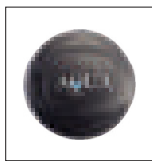

## DWXD 604 - BOPP SPORT

XDDESIGN<sup>®</sup> Bopp Sport is a remarkable sports bottle. The iconic shape gives multiple solutions to carrying the 550ml bottle. The leakproof closure can be easily opened and closed for immediate use. Made of durable Tritan<sup>®</sup> material. Registered design<sup>®</sup>

Print Technique : SC, UV Preferred Print Location: Cap / Front Down  
 Max Print Size : 35 x 15 mm Product Size : 24.1 x ø6.8 cm  
 Packing Details : 27.5 x 69.5 x 53.5 cm ; 48 pcs /carton ; gw/nw : 14.2 kg / carton

READY STOCK



## GSBG 915 - MANIKE MANICURE SET & KEYCHAIN

Gift set consisting of a manicure set and a keychain. Manicure set consists of Nail file, Cuticle pusher, Nail clipper and toe nail Clipper. Packed in a nice gift box.

(Box) Print Technique : SC, UV Preferred Print Location : Front Plate  
 Max Print Size : 35 x 10 mm  
 (Keychain) Print Technique : SC, UV, ENG Preferred Print Location : Front  
 Max Print Size : 30 x 30 mm  
 (Manicure Set) Print Technique : SC, UV, ENG Preferred Print Location : Front  
 Max Print Size : 90 x 40 mm  
 Product Box Size : 14 x 16 x 3 cm  
 Packing Details : 34 X 29 X 38.5cm; 40 pcs/carton; gw/nw: 10.3 kg/carton

# Tacx

Made in THE NETHERLANDS

BIO BOTTLES MADE IN THE NETHERLANDS

Tacx bio-bottles is the water bottle for the Pro teams. This sturdy water bottle features a powerful design and a screw-on cap. A Tacx bio-bottle distinguishes itself thanks to a number of excellent functionalities and is easy to fill and clean.



WB 003  
 Transparent /  
 Purple Lid 750CC

WB 003  
 Transparent /  
 Pink Lid 750CC

- > Bio Degradable
- > 100% Recyclable
- > Safe for Food Use
- > Screw-On Cap With A Leak Proof Spout
- > Secure Grip On Triangular Cap For Easy - Opening And Closing Of Bottle
- > Certified Bio-Degradable Water Bottles.
- > FDA Approved For Contact With Food.
- > OSHA Approved As Non-Hazardous.
- > Indefinite Shelf Life.



Print Technique : UV, SC Preferred Print Location : Center  
 Max Print Size : (Flat) 33 x 100 mm, 230 x 100 mm ( Round )  
 Product Size : 7.5 x 25 X 7.5 cm  
 Packing Details : 39 x 39 x 52 cm ; 50 pcs /carton ; gw/nw: 5.5 kg / carton



## QUATRO UD 795 - Pink

XDDESIGN<sup>®</sup> Quatro brings the 4 most common plugs into just one cable: Apple Lightning, Apple Dock, Micro USB and Mini USB. Now you can have them all together on a handy keychain so you'll never be without the right connector. Registered design<sup>®</sup>

Print Technique : SC, UV Preferred Print Location : Front  
 Max Print Size : 25 x 25 mm Product Size : 14.5 x 5 x 1 cm  
 Packing Details : 36 x 34 x 18 cm ; 100 pcs /carton ; gw/nw: 9.1 kg / carton



**MOLESKINE**

**CLASSIC NOTEBOOK FEATURES**

Scan Below QR code to watch product video



- > Hard cover, rounded corners, elastic closure
- > Ribbon bookmark
- > Expandable inner pocket in cardboard and cloth
- > Front endpaper with 'in case of loss' notice
- > Ivory-coloured 70 g/m<sup>2</sup> acid-free paper
- > Elastic closure, ribbon bookmark, innerpocket
- Fabric matches cover colour

**Large ( 13 x 21 cm ) - Hard Cover - Ruled Notebooks**



OWMOL 305 - Red    OWMOL 307 - White    OWMOL 313 - Citron Yellow    OWMOL 314 - Orchid Purple  
 Packing Details : 47 x 33 x 24cm ; 48 pcs /carton ; gw/nw : 18 kg / carton

**READY STOCK**

**XD COLLECTION**



A5

- > A5 Hard Cover Notebook With Pen
- > 160 Pages Of 70g/m<sup>2</sup> Inside
- > Gift Box

**GSXD 113 -**  
**XD COLLECTION** Ruled A5 hardcover standard notebook set including pen. 160 pages of 70g/m<sup>2</sup> inside. White coloured pages. Packed in Gift box.  
 (Notebook)Print Technique : UV, SC Preferred Print Location : Front  
 Max Print Size : 120 x 180 mm Preferred Print Location : Next to clip  
 (Pen)Print Technique : UV, SC Preferred Print Location : Next to clip  
 Max Print Size : 25 x 7 mm  
 Product Box Size : 22.5 x 17.2 x 2 cm  
 Packing Details : 38 x 25 x 36 cm ; 32pc /carton; gw/nw: 10.7kg / carton

**XD COLLECTION**



A6

- > A6 Hard Cover Notebook With Stylus Pen
- > 144 Pages Of 70g/m<sup>2</sup> Inside
- > Gift Box

**GSXD 124 - ALBURY**  
**XD COLLECTION** Ruled A6 hardcover classic notebook set including aluminium stylus pen. With elastic closure and bookmark ribbon. 144 pages of 70g/m<sup>2</sup> inside. Cream coloured pages. Packed in Gift box.  
 (Notebook)Print Technique : UV, SC Preferred Print Location : Front  
 Max Print Size : 110 x 60 mm  
 (Pen)Print Technique : UV, SC Preferred Print Location : Next to clip  
 Max Print Size : 25 x 7 mm Product Box Size : 15.7 x 12.2 x 2 cm  
 Packing Details : 46 x 19 x 30 cm ; 40pc /carton; gw/nw: 6.5 kg / carton

**Giftology**



A5

- > Pen Attaches To The Magnet On The Notebook
- > 160 Pages ; 80 gsm
- > Gift Box

**GSGL 305 - CAMPINA**  
**Giftology** Campina is an A5 notebook with magnet inside the cover to attract the included matching twist action metal pen. The notebook consists of 80 sheets/160 pages of 80 gsm. Packed in a gift box.  
 (Notebook)Print Technique : UV, SC Preferred Print Location : Front  
 Max Print Size : 90 x 180 mm  
 (Pen)Print Technique : UV, SC Preferred Print Location : Next to clip  
 Max Print Size : 30 x 7 mm Product Box Size : 15.5 x 21.8 x 1.7cm  
 Packing Details : 38 x 35 x 35.5 cm; 50 pcs /carton; gw/nw: 5.5 kg /carton



# LADIES GIFTS



READY STOCK

Bronze

Gold

Silver

A5

### SURAKARTA

**NBMK 101** - Silver **NBMK 102** - Gold **NBMK 103** - Bronze

PU leather notepad in eye catching metallic colors. Available in golden, silver and bronze colors. With hard covers, elastic band and matching color fabric bookmark. Including 80 plain sheets in ivory color.

Print Technique : SC, UV, EMB

Preferred Print Location : Bottom Center

Max Print Size : 100 x 160 mm

Product Size : 14.7 x 21 x 1.5 cm

Packing Details : 37.5 X 23.5 X 37.5 cm ; 50pcs/carton ; gw/nw: 13.5 kg / carton



### EFNP 105 - Pink Notepad Pocket

Ecofriendly pocket notepad with 75 sheets of yellow sticky notes and neon strips in 5 exotic colours. Be organized!

Print Technique : SC, UV

Preferred Print Location : Front

Max Print Size : 50 x 75 mm

Product Size : 5.3 x 8 cm



Heart



Sunglass



Wink

### ADELANTO

**NBMK 104**- Heart **NBMK 105** - Sunglass **NBMK 106** - Wink

Notebook of cheerful emoji designs in eye-catching yellow color. With white rings, rigid cardboard covers in soft glossy finish and 40 blank sheets..

Print Technique : SC, UV

Preferred Print Location : Back

Max Print Size : 40 x 15 mm

Product Size : 8 x 9 x 1.1 cm

Packing Details : 28 x 19 x 63.5 cm ; 500 pcs / carton ; gw / nw : 11.5 kg / carton

## Giftology



Red

A5

➤ PU Notebook Cover

➤ 160 Ruled Pages, Rounded Corners

➤ 1300 Meters Writing Length For Pen

➤ Gift Box



Pink

### LIBELLET

**GSSL 203** - Red **GSSL 208** - Pink

Giftology Libellet is a notebook and pen set consisting of a hard cover PU notebook with a matching color pen with geometric design. The round cornered notebook consists of 160 ruled pages, 70 gsm with matching colored 3mm elastic closure, a bookmark and a pen loop. Packed in a gift box.

(Notebook) Print Technique : UV, SC, EMB

Preferred Print Location : Front Max Print Size: 210 x 140 mm

(Pen) Print Technique : UV, SC Preferred Print Location : Clip

Max Print Size: 8 x 37 mm Product Box Size : 22.5 x 19.5 x 2 cm

Packing Details : ; 30 x 25 x 40 cm ; 32 pcs /carton ; gw/nw: 12.50 kg / carton

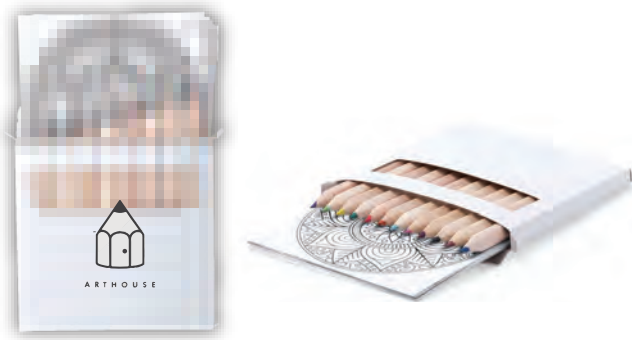

**STMK 136 - TARAKAN**

Set of pencils and coloring sheets with mandala designs to color and relax. Includes 12 hexagonal body pencils and 12 sheets with different designs. Presented in cardboard box with window. 12 Pencils and 12 Sheets Included

Print Technique : SC, UV Preferred Print Location : Front Cover  
 Max Print Size : 65 x 35 mm Product Size : 9 x 9 x 1 cm  
 Packing Details : 29 x 22 x 48 cm ; 300pcs /carton ; gw/nw: 13kg / carton



**STMK 137 - SORONG**

Set of 6 crayons in natural cardboard box. With cylindrical body in varied colors. Including crayons in 6 colors.a

Print Technique : SC, UV Preferred Print Location : Front Cover  
 Max Print Size : 35 x 50 mm Product Size : 5.3 x 9 x 0.9 cm  
 Packing Details : 26.5 x 21 x 28.5 cm ; 250pcs /carton ; gw/nw: 10kg / carton



**STMK 139 - BATU**

Box of 4 wooden pencils with hexagonal body and in natural finish. Presented in natural cardboard box with window.

Print Technique : SC, UV Preferred Print Location : Front Cover  
 Max Print Size : 40 x 20 mm Product Size : 3 x 9 x 0.8 cm  
 Packing Details : 27 x 23.5 x 47.5 cm ; 1000pcs /carton ; gw/nw: 12kg / carton



**STMK 102 - TERVEL**

Set of 6 pencils in natural cardboard box with window. Wooden pencils with hexagonal body in natural finish and in a wide range

Print Technique : UV, SC Preferred Print Location : Front Cover  
 Max Print Size : 35 X 55 mm Product Size : 4.5 X 9 X 0.8 cm  
 Packing Details : 24.5 X 24.5 X 37.5 cm ; 500 pcs / carton ; gw / nw : 9 kg / carton

READY STOCK

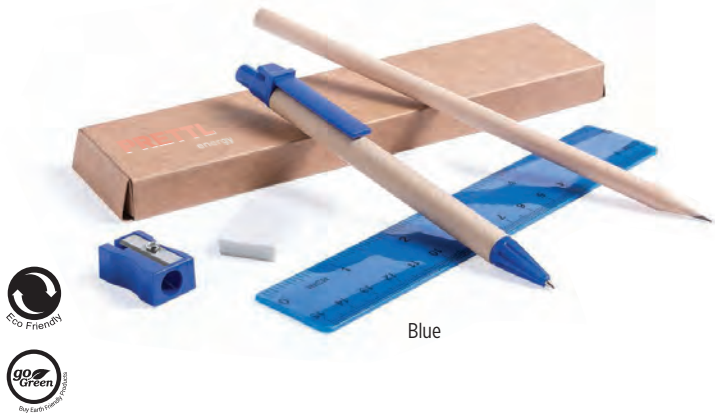

**BATAK**

**STMK 101 -Blue STMK 141 - Red STMK 142 - Green**

Set of 5 pieces presented in natural cardboard box. Includes push-up mechanism ball pen and blue ink in recycled cardboard, wooden cylindrical body pencil, pencil sharpener, rubber and 15 cm ruler.

Print Technique : UV, SC Preferred Print Location : Box Max Print Size : 100 X 30 mm  
 Product Size : 4.5 X 17.7 X 1.5 cm Packing Details : 38 X 34 X 48 cm ; 400 pcs / carton ; gw / nw : 14 kg / carton

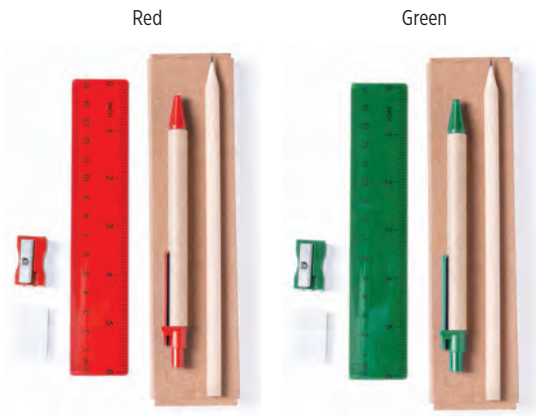



# KIDS STUFF



DELANO

SCMK 101 - White SCMK 102 - Red SCMK 103 - Blue

5 panel kid cap in bright colors. In 100% cotton material, with embroidered ventilation holes and adjustable velcro closure.

Print Technique : SC, EMBROIDERY Preferred Print Location : Front

Max Print Size : 80 x 45 mm

Packing Details : 64 X 40 X 44 cm ; 15 kg Pcs: 300/ carton



GA 120 - GHISTU

Flaunt your love of golf with your own mini golf course. Get amateur putting practice in the office or play with children at home, while teaching them the basics of golf.

Print Technique : UV, SC, ENG Preferred Print Location : Side

Max Print Size : 340 x 20mm Product Size : 37.5 x 12 x 3.5cm



Output : Lightning, Micro USB & Type-C  
Charges Device & Transfers Data

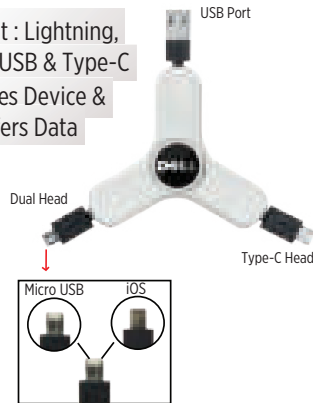

Stress-Relieving Fidget Spinner  
3 In 1 Charging Cable

MTST 701 - SPINCER

Giftology Spincer is a fidget spinner with 3 in 1 Integrated charging & data transfer cable which includes a Type-C output & a Dual sided output : Lightning & Micro USB. With Lightning output, Micro USB & Type-C plug Spincer can charge almost all phones. A playful fidget spinner & integrated charging cable that caters to almost all the smart devices makes Spincer a must-have accessory.

Print Technique : UV, SC, DOM Preferred Print Location : Center

Max Print Size : ø24 mm Product Size : 8.5 x 8.5 x 1.1 cm

Packing Details : 44 x 19.5 x 39 cm; 200 pcs/carton; gw/nw: 9.5 kg/carton



DT 646 - LOMBL

Desktop Clock with Maze Game

Print Technique : UV, SC Preferred Print Location : Bottom

Max Print Size : 60 x 15 mm Product Size : 8 x 10 x 4.3 cm

Packing Details : 38 x 28 x 35.7 cm 60 pcs /carton; gw/nw: 8 kg/carton

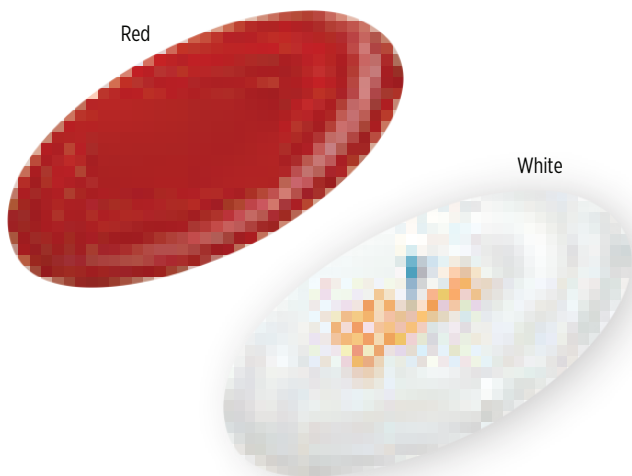

BURGAS

GMMK 104 - White GMMK 106 - Red

Frisbee

Print Technique : SC Preferred Print Location : Center

Max Print Size : ø100 mm Product Size : 1.8 X ø23 cm

Packing Details : 33 X 50 X 74 cm ; 300 pcs / carton ; gw / nw : 16.5 kg / carton



GMMK 103 - BYALA

Classic skill game mikado with 41 wooden sticks. Presented in wooden box with sliding cover.

Print Technique : ENG, SC

Preferred Print Location : On the side

Max Print Size : 100 X 20 mm

Product Size : 19.3 X 2.5 X 4.1 cm

Packing Details : 47 X 21 X 28 cm ; 100 pcs / carton ; gw / nw : 10 kg / carton

READY STOCK



# HAPPINESS THEME GIVEAWAYS



STAY HAPPY STAY HEALTHY !!



ARCATA

STMK 143 - Heart STMK 146- Wink

Ball pen with fun emoji designs in eye-catching yellow color. With push-up mechanism, soft body in glossy finish and original circular clip. Blue ink.

Print Technique : SC

Preferred Print Location :

Max Print Size : SC, 50 x 5 mm Product Size: 14 x ø0.9 cm

Packing Details : 35 x 51 x 51 cm ; 1000 / carton ; gw / nw : 12.5 kg / carton



DUBLIN

DWMK 104 - Heart DWMK 105 - Sunglass DWMK 106 - Wink DWMK 107 - Smile

370ml, ceramic mug with fun emoji designs in eye-catching yellow color. Presented in an individual box.

Print Technique : SC, UV Preferred Print Location : Front

Max Print Size : 38 x 60 mm Product Size: 8.2 x 9.8 cm

Packing Details : 33 x 27.5 x 48 cms ; 36 pcs / carton ; gw / nw : 13 kg / carton

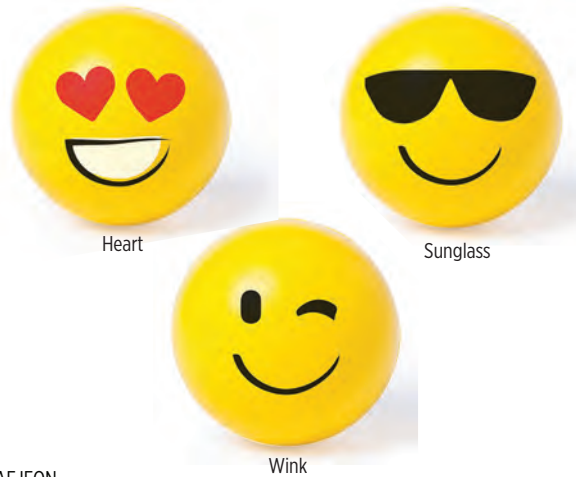

DAEJEON

SBMK 101 - Heart SBMK 102 - Sunglass SBMK 103 - Wink

Soft anti-stress ball with fun emoji designs in eye-catching yellow color.

Print Technique : SC, UV, Pad printing Preferred Print Location : Front

Max Print Size : 30 x 30 mm

Product Size: ø6.2 cm

Packing Details : 50.5 x 31.5 x 60cms ; 400 pcs / carton ; gw / nw : 7 kg / carton



ADELANTO

NBMK 104 - Heart NBMK 105 - Sunglass NBMK 106 - Wink

Notebook/Notebook of cheerful emoji designs in eye-catching yellow color. With white rings, rigid cardboard covers in soft glossy finish and 40 blank sheets..

Print Technique : SC, UV Preferred Print Location : Back

Max Print Size : 40 x 15 mm Product Size: 8 x 9 x 1.1 cm

Packing Details : 28 x 19 x 63.5 cm ; 500 pcs / carton ; gw / nw : 11.5 kg / carton



ARTESIA

BPMK 122 - Heart BPMK 123 - Sunglass BPMK 124 - Wink BPMK 125 - Smile

Folding bag with fun emoji designs in eye-catching yellow color. Made of soft 190T polyester, with matching color drawstring and adjustment accessory.

Print Technique : SC, HT Preferred Print Location : Front

Max Print Size : 265 x 200 mm Product Size: 40 x 38 cm

Packing Details : 20x 45x55 cm ; 400 / carton ; gw / nw : 10 kg / carton

READY STOCK



# AUTOMOBILE EARBUDS FOR YOUR MOBILE

Small Headset



- > Safe Handsfree Experience
- > Bluetooth 4.0 For Smooth Connection
- > Charge And Call While Driving
- > Compatible With All Mobile Phones

### ITCC 701 - FYCAR

**@MEMORii** Fycar is a unique design car charger with dual USB output and with integrated bluetooth headset that allows a safe hands-free experience whilst driving. The integrated earbud is charged when driving and is ultra-portable due to its small design (20 x 33 mm). The device uses the advanced bluetooth 4.0 connection which ensures a smooth connection and perfect sound quality. The magnetic top of the charger allows you to easily place the earbud back in the dock to charge it. The charger is suitable for all mobile phones. The earbud comes with additional ear tips in different sizes to fit all. Output 5V/1A ; 5V/2.1A

Print Technique : UV, SC, ENG  
Product Size : 8.6 x ø 2 cm

Preferred Print Location : Front  
Packing Details : 37.5 x 30.5 x 17 cm ; 40 pcs/carton ; gw/nw ; 4.75 kg/carton

Max Print Size : 35 X 7 mm

READY STOCK



### ITXD 740 - PENRITH

**XD COLLECTION** Car charger with Unique design & integrated wireless headset that allows a safe hands-free experience whilst driving. The integrated earbud is charged when driving and is ultra-portable due to its small design (20 x 33 mm). The magnetic top of the charger allows you to easily place the earbud back in the dock to charge it. The charger is suitable for all mobile phones. The earbud comes with additional ear tips in different sizes to get a good seal for all & can be used up to one hour on one single charge and can be fully re-charged in 1.5 hours. Output 5V/1A.

Print Technique : UV, SC, ENG Preferred Print Location : Front

Max Print Size : 35 x 7 mm Product Size : 8 x ø2 cm

Packing Details : 38.5 x 33.5 x 30 cm ; 80 pcs /carton ; gw/nw : 5.5 kg / carton



### ITXD 741 - GRAFTON

**XD COLLECTION** Car charger with integrated wireless earbud using wireless BT 4.1 for perfect connection. The magnetic top of the charger allows you to easily place the earbud back in the dock to charge it. The charger is suitable for all mobile phones. The earbud comes with additional ear tips in different sizes to get a good seal. ABS material. Input 12-24V/output 2.1A. Registered design®

Print Technique : UV, SC, ENG Preferred Print Location : Front

Max Print Size : 7 x 20 mm Product Size : 8 x 3 cm

Packing Details : 55.0 x 35.0 x 21.0 cm ; 96 pcs /carton ; gw/nw : 8.6 kg / carton



READY STOCK



- > Automobile Jump Starter
- > Jump Starts Cars, SUVs, Vans & Trucks
- > Powerful Powerbank
- > Multiple Light Modes Torch



**ITPB 835 - TOKOROA**

Tokoroa is a powerful aluminium alloy body Jump Starter with 11200 mAh capacity capable of powering cars, SUVs, Pickup Truck, Van etc. 20 to 30 times. It can also be used as a powerbank capable of charging tablets and smartphones. Additionally, it features an 800 lumens torch with different lighting modes Max/Medium/Minimum/Flashing/SOS. Jump starting Voltage DV 12V, Starting current- 400A, Peak Current- 600A (<0.5 sec). Power Bank Input & Output- 5V/2A.

Print Technique : SC,UV, ENG Preferred Print Location : Any Side Max Print Size : 25 x 90 mm  
Product size : 5.7 x 5.7 x 21 cm Packing Details : 40 x 34 x 36cm; 10pc/carton; gw/nw: 8.6/9.3 kg /carton



- > 5W Wireless Charger
- > Charge Hands-free And Without Cables
- > Gravity Induction Air Vent Mounting



Scan Below QR code to watch product video



ITWC 201 - ESTELI

Giftology Gravity induction 5 Watt wireless car charger that allows for a hands free safe car drive. The phone (up to 6") is held securely in place by the two holders on the side to keep the item stable when driving along with built- in LED indicator to indicate when the phone is charging. Input-Type C 5V/1A, Output-5V-1A/5Watts wireless.

Print Technique : UV, SC, ENG  
Product Size : 22.1 x 14.6 x 1.26 cm

Preferred Print Location : Plate  
Packing Details : 36.5 X22 X 40.5 cm; 24 pcs/carton; gw/nw: 4.9kg/carton

Max Print Size : 35 x 55 mm

READY STOCK

### 6 in 1 Car Emergency Multitool



Seat belt cutter

Torch + Siren light + Car Charger



2200mAh Powerbank



Glass breaker



ITPB 405 - SHIELD

@MEMORI 6 in 1 Multifunctional car charger consisting of a car charger, 2200 mAh power bank, safety hammer, seat belt cutter, torch and emergency warning light. All the accessories required in emergency use are available in this compact device. Car charger input 12V-24V USB input 5V/1A USB Output 5V/1A

Print Technique : UV, SC  
Max Print Size : 25 x 13 mm

Preferred Print Location : Center  
Product Size : 11.5 x 4 x 2.5 cm  
Packing Details : 40 x 29 x 15 cm; 50 pcs /carton; gw/nw: 6.2 kg / carton



- > Useful Car Accessory
- > Car Phone Stand With Glass Breaker And Seat Belt Cutter
- > Excellent Branding Space

Seat belt cutter

Glass Breaker

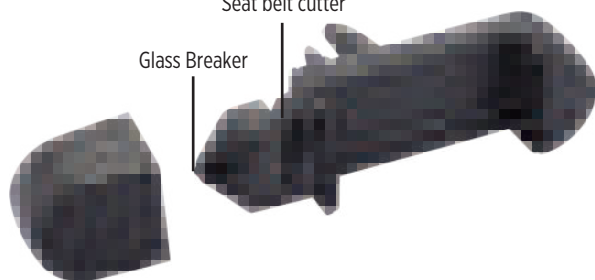

MTGL 401 - BRNO

Giftology Brno is a car phone holder with seat belt cutter and glass breaker. The excellent branding space on this product makes it an affordable and useful promotional product. Packed in a box.

Print Technique : UV, SC  
Product Size : 9.7 x 5 x 2.8 cm

Preferred Print Location : Front  
Packing Details : 36.5 x 24.5 x 28.5 cm; 100pc/carton; gw/nw: 5.2 kg / carton

Max Print Size : 25 x 15 mm

# AUTOMOBILE ACCESSORIES/ CAR PHONE HOLDERS



Blue

Red

➤ Double Telescopic Fixing System

➤ Bicolor Design



KERMAN

MTMK 104 - Blue

MTMK 105 - Red

Smartphone holder with double telescopic fixing system for car ventilation grill. In a stylish bicolor design, it incorporates a system of pads in the stand that provides optimum fit and protection for your smartphone.

Print Technique : SC, UV, DM

Preferred Print Location : Front

Max Print Size : 30 x 7 mm

Product Size : 7.8 x 4 x 2.5 cm

Packing Details : 23 X 38.5 X 56 cm ; 13.5 kg ; 400pcs / carton



MTMK 107 - LONE

Portable car mount for smartphones. With expandable grip that holds any smartphone with or without smartphone cover or case. Also has a 360° rotation head for flexible angle viewing.

Print Technique : DOM, UV

Preferred Print Location : Front

Max Print Size : 10 x 20 mm

Product Size : 9.7 x 2.8 x 5 cm

Packing Details : 50 X 31 X 38 cm ; 10 kg ; 300pcs / carton



➤ Strong Magnet

➤ Excellent Branding Space

MTMK 106 - BEKASI

Magnetic holder for smartphone with minimalist design and elegant black aluminum finish combined. With telescopic fixing system for car ventilation grill and adhesive accessory for smartphone. Presented in an attractive design box.

Print Technique : SC, ENG

Preferred Print Location : Side & Front

Max Print Size : 20 x 20 mm

Product Size : Ø3.5 cm

Packing Details : 36.5 X 36 X 46 cm ; 200pcs / carton ; gw / nw : 11 kg / carton



➤ Car Emergency Multitool

➤ Multi-functional Seat Belt Cutter & Glass Breaker



MT 356 - THOR

XDDESIGN® Thor adds design to traditional Car Safety Hammer. It is the help you need during any car break down or even an accident. It combines safety hammer and seatbelt cutter in a robust body. Manual included. Registered design®

Print Technique : UV, SC

Preferred Print Location : Front

Max Print Size : 20 x 70 mm

Product Size : 17.5 x 3 x 8.5 cm

Packing Details : 0.06857 cbm ; 80 pcs / carton ; gw / nw : 19 kg / carton

READY STOCK



# SUNSHADES & MULTITOOLS



### UI 1212 - TIPATO

Silver / Black Polyester Sunshades

Print Technique : SC

Preferred Print Location : Center

Max Print Size: (Sunshade) ø500 mm (Pouch) ø130 mm

Product Size : 150 x 70 cm

Packing Details : 57 x 70 x 14 cm; 100 pcs /carton; gw/nw: 14 kg/carton



Black



Red



READY STOCK

### UI 1214 - PHUOSE

Dupont Tyvek Larger Sunshade for SUVs

Print Technique : SC Preferred Print Location : Center

Max Print Size: (Sunshade) ø500 mm (Pouch) ø130 mm

Product Size : 155 x 75 cm

Packing Details : 75 x 70 x 13 cm; 100 pcs/carton; gw/nw: 15 kg/carton

### UI 1213 - SAIOTU

DUPONT TYVEK SUNSHADES Stocks available in original Dupont Tyvek

Sunshades (White) with a range of border colours to match logo & print matter

Print Technique : SC Preferred Print Location : Center

Max Print Size : (Sunshade) ø500 mm (Pouch) ø130 mm

Product Size : 150 x 70 cm

Packing Details : 55 x 71 x 11 cm; 100 pcs/carton; gw/nw: 15.7 kg/carton



Pocket Lightweight



### MTMP 205 - CALIPA

Giftology Calipa is a 15 in 1 multipurpose tool that comes in a nylon pouch. Be ready to face daily challenges with this small yet useful tool!

Print Technique : ENG, HT

Preferred Print Location : On Hand Grip

Max Print Size : 30 x 5 mm

Product Size : 10 x 3.5 x 1.4 cm

Packing Details : 29.1 x 32.3 x 27.8 cm; 40 pcs/carton; gw/nw: 13.6kg/carton

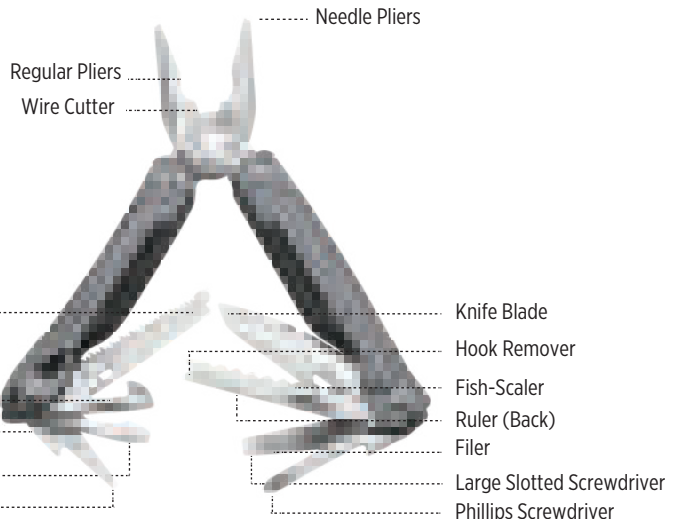

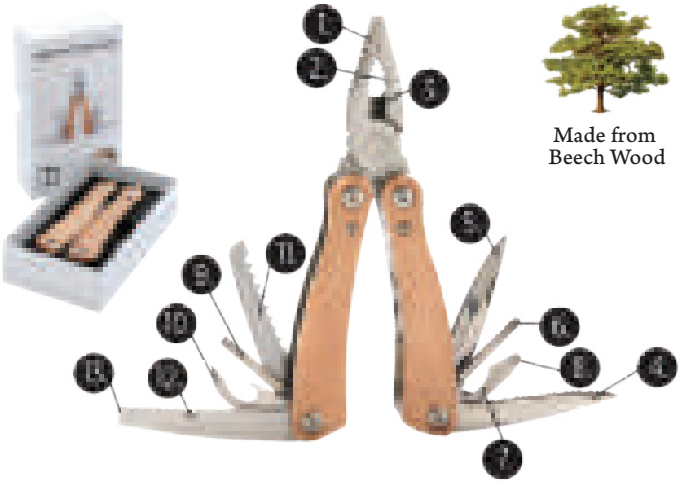

Made from Beech Wood

- 01 Large nose pliers
- 02 Standard pliers
- 03 Wire cutter
- 04 Serrated blade
- 05 Knife
- 06 Phillips screwdriver
- 07 Bottle opener
- 08 Flat screwdriver
- 09 Small flat screwdriver
- 10 Can opener
- 11 Saw
- 12 File
- 13 Large screwdriver

**MTXD 101 - WOOD MULTITOOL**

**XDCOLLECTION** Strong and durable multitool with 13 functions. With beech wood case and high quality stainless steel tools. Tools include: Long nose plier, standard plier, wire cutters, serrated blade, bottle opener, large flat screwdriver, phillips screwdriver, knife, saw, small flat screwdriver, can opener, medium flat screwdriver, file. Packed in gift box.

Print Technique : SC,UV, ENG Preferred Print Location : Front Max Print Size : 40 x 10 mm  
 Product Size : 2.1 X 4.6 X 9.8 cm Packing Details : 40 X 19 x 29.50 cm ; 40 pcs /carton ; gw/nw: 11.5 kg / carton

**XDDESIGN®**



Designed by :



Antoine France

Scan Below QR code to watch product video



**MT 354 - TOVO**

**XDDESIGN® Tovo** is the ultimate multitool for the Urban adventurer. The sleek handle in combination with the stainless steel tools provide a completely new look and feel. The multitool is supplied with a neoprene pouch and carabiner so it can be stored and hooked anywhere. No obstacle is too big anymore with this tool's elaborate 16 functions. Registered design®

Print Technique : SC, UV Preferred Print Location : Front Max Print Size : 70 x 10 mm  
 Product Size : 10 x 6 x 2 cm Packing Details : 36.5 x 36 x 44 cm ; 40 pcs /carton ; gw/nw: 14.5 kg / carton

READY STOCK



- 7 Barbecue Tools In 1
- Easy To Store, Compact Size
- Made Of Stainless Steel

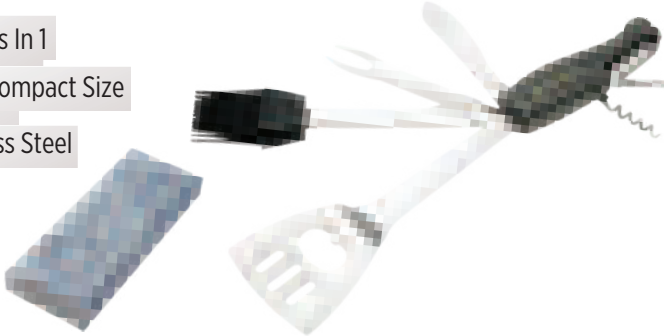

**MTSW 810 - BARBECUE**

**SWISS PEAK®** Barbecue is a 7 in 1 foldable barbecue tool which enables you to have all the essentials in a compact foldable form. Become a Grillmeister with perfect tools in hand - a two-prong fork, knife, spatula, brush, bottle opener, corkscrew and cross screwdriver. Made of high grade stainless steel and foldable attribute makes it easy to store.

Print Technique : UV,SC Preferred Print Location : on handle Max Print Size : 15 x 45 mm  
 Product Size : 17.8 x 6.2 x 1.8 cm Packing Details : 27.5 x 20.5 x 32 cm ; 40pcs /carton ; gw/nw:11.51 kg / carton



# Giftology

- > Torch
- > Booklight



MTGL 811 - SUNDSVALL

Giftology Sundsvall is a multifunctional torch with booklight to brighten up the darkest spaces. Packed in a gift box.

Print Technique : UV, SC Preferred Print Location : Booklight Max Print Size : 15 x 55 mm  
Product Size : 6.5 x 6.5 x 19.8 cm Packing Details : 68 x 35 x 43.5 cm; 100 pcs/carton; gw/nw: 14 kg/carton

READY STOCK



KT 011 - COUNTD

Countdown Clock - Constant Reminder of Major Events

Print Technique : UV, SC  
Preferred Print Location : Top  
Max Print Size : 80 x 50 mm  
Product Size : 8.5 x 5.5 x 1 cm



VRANJE

MSLC 886- Green MSLC 887- White MSLC 888 - Orange  
MSLC 889 - Light Blue MSLC 890 - Royal Blue MSLC 891 - Black  
MSLC 892 - Yellow

Silicone Wrist Band



GS 1201 - DRIMU

LED torch with Batteries and pen in gift box

Print Technique : SC,UV  
Preferred Print Location : (Torch) Front  
Max Print Size : 40 x 10 mm  
Print T : SC, UV Print L : (Pen) Barrel  
Max Print Size : 50 x 5 mm  
Product Size : 6.6 x 16.7 x 2.3cm  
Packing Details : 49 x 38 x 30 cm;  
120 pcs/carton; gw/nw: 10.6 kg/carton



CD case in soft PU. by Tonino Lamborghini

CERASI - 98196-30

Print Technique : SC Preferred Print Location : Front  
Max Print Size : 100 x30 mm Product Size : 14.5 x 16.5 x 3 cm  
Packing Details : 50.5 x 48.5 x 32.5 cm ; 60 pcs/carton ; gw/nw: 11 kg / carton





Pierre Cardin  
PARIS



Playing Cards Set

- > PIERRE CARDIN playing cards set
- > Premium wooden box
- > Silver PIERRE CARDIN logo

PGPC 772 - TROCANO

Print Technique : SC, ENG Preferred Print Location : Top of Box  
 Max Print Size: 20 x 30 mm Product Size : 11 x 15.8 x 3.2 cm  
 Packing Details : 57 x 36 x 36 cm ; 68 pcs /carton ; gw/nw: 31.5 kg / carton

Pierre Cardin  
PARIS



Wine Accessory

- > PIERRE CARDIN wine set
- > Premium wooden box
- > Silver PIERRE CARDIN logo

MCPC 771 - CONCONA

Print Technique : SC, ENG Preferred Print Location : Top of Box  
 Max Print Size: 20 x 30 mm Product Size : 15.5 x 4.7 x 10.8 cm  
 Packing Details : 57 x 36 x 36 cm ; 54 pcs /carton ; gw/nw: 23.3 kg / carton

READY STOCK



eco-neutral



HELEN 197 - HELLA

**eco-neutral** A compact and convenient alternative to single-use plastic cutlery. Make a natural choice with our Wheat Straw Cutlery Set consisting of a knife, spoon and fork packed in a convenient wheat straw box.

Print Technique : UV, SC Preferred Print Location : Case Max Print Size : 190 X 50 mm  
 Product Size : 20.3 x 5.5 x 2.2 cm Packing Details : 32 X 24 X 49 cm ; 100pcs /carton ; gw/nw: 7.4 / 7.8 kg / carton

CUTLERY SET



**Bukhoor is the Arabic name given to scented bricks or a blend of natural traditional ingredients, mainly wood chips (Oudh the Arabic name for Agarwood/Aloeswood) soaked in fragrant oils and mixed with other natural ingredients (resin, ambergris, musk, sandalwood , essential oils and others).**

## 10 Fragrances

- Blue Musk
- Bull gin black
- Cool Terrain
- Lavender
- Mukhallat
- Oudh
- Rose Lilly
- Vanilla Arch
- White Oudh
- Zoya

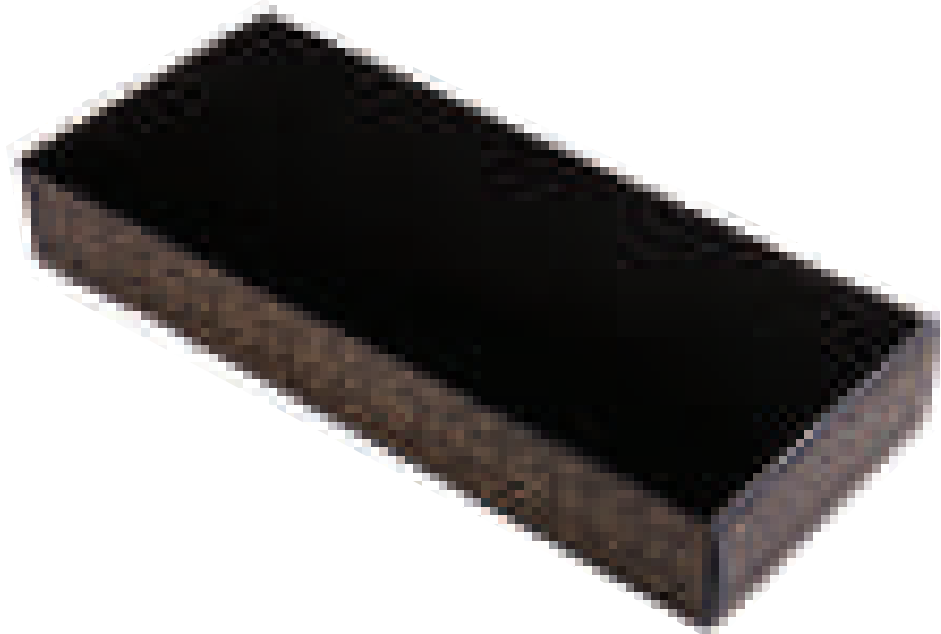

READY STOCK



10 Assorted Fragrances in One Gift Pack= 50Tablets



50 Tablets of Vanilla Arch Fragrance



50 Tablets of White Oudh Fragrance

- > Small Tablets for Frequent use
- > No Coal required for burning; ignites with lighter
- > Non-Toxic ingredients used- Certified by MSDS Reports

- > Try assorted 10 fragrances or just Vanilla or just Oudh
- > Each Gift Pack = 10 Containers = 10 X 5 = 50 Tablets; good for almost 2 months of daily one-time use

BUKHOOR GIFT PACK

GSBK 381 - Glinde - Bukhoor Gift Pack - Assorted Fragrances    GSBK 382 - Aurich - Bukhoor Gift Pack - Vanilla Arch Fragrance

GSBK 383 - Ebern - Bukhoor Gift Pack - White Oudh Fragrance

# BOXES



**PB 1053** - Paper Pen Sleeve Packing  
Sleeve Size : 1.2 X 3 X 16.1 cm



Velvet Pen Sleeve  
**GPMK 102** - Black **GPMK 103** - Grey  
Sleeve Size : 2.5 X 15.5 cm



**PB 762** - Pen Box (Paper)  
Box Size : 17 X 2 X 4 cm



**PB 245** - Plastic Pen Box (Set)  
Box Size : 1.8 X 4 X 17 cm



**WIPB 110** - Paper Pen Box  
Box Size : 17.7 X 2 X 5.7 cm



**WIPB 101** - (Box for Pens)  
Box Size : 17.4 X 2.7 X 6.6 cm

READY STOCK



**PB 1045** - Metal Pen Box (Available 4 colors)  
Box Size: 1.8 X 3.9 X 17.8 cm



**PB 1055** - Hard board paper box for set of 2 pens  
Box Size : 17.5 X 3 X 7.5 cm

# BOXES



**PB 1002** - Pen Box  
Box Size : 3.6 X 5 X 17 cm



**PB 1001** - Paper Pen Box  
Box Size : 2.5 X 7.5 X 17.5 cm



**GSPB 184** - Wallet & Pen Set  
Box Size : 3.6 X 18 X 18 cm

READY STOCK



**PB 1050** - Wallet, Pen & Keyring Set  
Box Size : 4.1 X 16.7 X 19.4 cm



**WPK** - Wallet, Pen & Keyring Set  
Box Size : 3.4 X 15 X 21.4 cm



**PB 1052** - Box for Travel Wallet  
Box Size : 4.2 X 17 X 25.7 cm



**CHKC Box** - Card Holder & Key holder Set  
Box Size : 3 X 14.3 X 15.3 cm

# BOXES



**MWKC Box** - Men's Wallet & Key holder set  
Box Size : 3 X 14.3 X 15.3 cm



**WCC Box** - Box for Wallet & Card holder / Ladies wallet  
Box Size : 3.2 X 12.8 X 24.8 cm

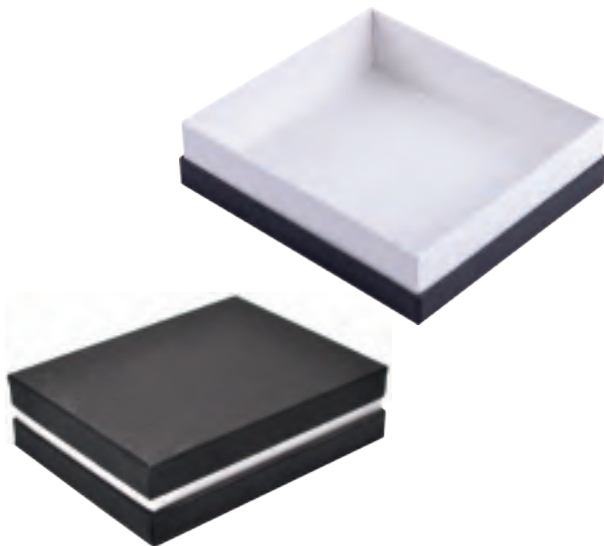

**MAPB 101** - Santhome Wallet box  
Box Size : 3.4 X 11.5 X 13 cm



**PB 1034** - Wallet, Card holder & Pen Set (Packaging for Biomaster products)  
Box Size : 4.4 X 19.3 X 25.3 cm

READY STOCK



**PB 1041** - Hard box for Card holder  
Box Size : 2.1 X 7.1 X 11.3 cm



**MW Box** - Wallet Box  
Box Size : 3.2 X 12.5 X 15.8 cm

# CLEARANCE

## UV-C steriliser pouch

- UV-C Kills 99.9% bacteria
- External Material is Anti-Microbial
- Non - Toxic; Without Mercury



**ITSN 102 B**  
Max Print Size : 75 X 70 mm

## Fitness Watch



1.54" Full Touch Screen



Long Battery Life (10 - 12 days)



Yoga guide - Mindfulness



Multi Sport Mode



Pedometer



Find My Phone



Notifications



Blood Pressure



Heart Rate



Sleep Monitoring

**WNAT 818**  
Max Print Size : 40 x 10 mm

READY STOCK



**ITXD 818 - ENCORE WIRELESS POWERBANK**  
Max Print Size :30 X 50 mm



- 5 Watt X 2 Bluetooth Speaker With Microphone
- Elegant Fabric front cover
- 2000mAh Internal battery



**ITSP 715 - BLUETOOTH SPEAKER**  
Max Print Size : 170 x 80 mm



**BPGL 215 - BACKPACK**  
Max Print Size : 200 x 180 mm



**BGXD 811 - BACKPACK**  
Max Print Size : 120 X 150 mm



**ITPB 402 - 4IN1 CAR CAMPING ACCESSORY**  
Max Print Size : 20 X 30 mm

Emergency Light



Camping Light



All Clearance items are quality checked and approved

# GLOSSARY

Except wherever mentioned as customised, the page numbers refer to Ready Stocks

PAGE NO

A-G

PAGE NO

<b>@memori</b>		<b>Caps</b>	303-306
Activity Trackers & Fitness Watches	85	<b>Car Requisites / Related</b>	433-437
Automobile Technology Gadgets & Accessories	433-435	<b>CHANGE COLLECTION- SUSTAINABLE</b>	8-11, 13-16, 19-20
Clocks Multifunctional	365	<b>Charging Cables</b>	116-117
Earphones, Earbuds, Headphones & Speakers	82-83, 114	<b>Children / Kids Items as Toys and Games</b>	430-432
Powerbanks & Charging Cables	94-101, 116-117	<b>CLEARANCE ITEMS</b>	445
Travel Adapters	129-130	<b>Clocks including Multifunctional</b>	365, 369-370, 372
VR Glasses	123	<b>Cork Articles series</b>	47, 54, 55
Wireless Chargers & Wireless Powerbanks	85-94	<b>Credit Card / Business Card Holders</b>	379-387, 412
<b>Activity Trackers &amp; Fitness Watches</b>	84-85	<b>CROSS Accessories</b>	167-170, 410-414
<b>ANTI- MICROBIAL/ BACTERIAL/ VIRAL/ COVID</b>	59-82	<b>CUSTOMISED ITEMS</b>	
BACKPACKS	77-78	Bags and Stitched Articles	182-188
GOGGLES SAFETY & KEYHOLDERS	66-67	Diaries	361-362
LEATHER ACCESSORIES	398-401	Polo Shirts, Tshirts, Sportswear, Winterwear, Uniforms, Coveralls	261-266 265-266
MASKS & ACCESSORIES	63-66, 68, 70	<b>Day Bags / Sling Bags</b>	144, 163
NOTEBOOKS, PENS	69, 70	<b>Desktops &amp; Desk/ Table Accessories</b>	363-373
POLO SHIRTS, T-SHIRTS, CAPS	70-73	<b>Diaries including MOLESKINE</b>	312, 361-362
SAFETY KITS	73-76	<b>Drinkware including Related Sets</b>	189-235
SANITIZERS- HAND- DABUR DERMOVIVA	67	<b>DRYNCOOL</b>	
TECH- POWERBANKS, WIRELESS CHARGERS, ETC	59-62	Polo Shirts	269-286, 292-293
TWS EARBUDS	82	Caps	305
UV-C STERILISATION ARTICLES & GADGETS	77-82	<b>Earphones, Earbuds, Headphones</b>	82-83, 114-116
<b>AWARE COLLECTION-SUSTAINABLE</b>	07, 12, 17-18, 21-27	<b>econeutral and ECO-FRIENDLY</b>	7-62
<b>BAGS</b>	135-188	Apparel- Polos, Caps, Masks	12-14, 38
Backpacks	141-157, 159-164, 167-168, 395	Bags & Pouches, Shopping Bags, String Bags	15-26, 39-42, 44
Cooler Bags & Lunch Bags	174	Covid-Protection Mask	38
<b>Cotton Shopping Bags</b>	179-181	Drinkware & Eatware	8-11, 28-37, 216
Conference Bags- Economy	173	GRS / RCS Certified Materials Used	12-32, 39-40, 45, 49, 57
Customized Bags & Stitched Articles	182-188	Key Holders, Coasters & Card Holder	55-56
Day Bags / Sling Bags	144, 163	Kids Stuff and Games	53
Drawstring Bags	175-176	Pens, Notebooks & Stationeries, Desktops	27, 47-53
Duffle Bags	139-140, 174	Sunglasses	242
<b>Eco Friendly Bags</b>	136, 139-142, 144-146, 150, 153-154,	Tech	45-46, 56-62, 88-89, 102
<b>Eco Friendly Bags</b>	165-166, 176-182	Wellness & Fitness	54
Garment Bags	137	<b>FACE MASKS &amp; ACCESSORIES</b>	63-66, 70
<b>Jute Shopping Bags</b>	178	<b>FITNESS, WELLNESS, SPORT</b>	235-260
Laptop & Office Bags / Messenger Bags	158, 165-166, 169-173	<b>Flasks, Mugs, Tumblers</b>	191-192, 212-224
<b>Non Woven Shopping Bags</b>	177	<b>Folders with / without In-built Powerbanks</b>	86, 107-111, 332, 357-360, 414
Prayer Mat Bags	183	<b>Fruit Infuser Water Bottles</b>	208-209
School Bags (Customised & Ready Stocks)	163, 185	<b>Gift Sets</b>	73-76, 122, 133, 226-234, 313-314, 328-329, 342, 387-390, 398, 401, 403-404, 407, 409, 439-440
Shopping Bags	177-181	<b>GIORDANO Shirts</b>	297
Sports & Gym Bags	139-140, 151, 162, 257		
Travel Bags incl toiletry, waist bag, shoulder bag	135-140, 239, 394		
Trolley Bags	137-138		
<b>BAMBOO SERIES ARTICLES (across categories)</b>	8, 10, 34, 36, 48, 50-51, 56, 58-62, 76, 83, 85		
<b>BIOMASTER-PROTECTION RANGE</b>	59-62, 398-401		
LEATHER ARTICLES, ACCESSORIES, SETS	398-401		
TECHNOLOGY ARTICLES	59-62		
<b>Blanket</b>	301		
<b>Bobby Backpacks from XDESIGN</b>	144-152		
<b>BOXES (PACKAGING)</b>	442-444		
<b>Branding Techniques</b>	05		
<b>Bukhoor</b>	441		
<b>Business / Credit Card Holders</b>	379-387, 412		
<b>c-Secure RFID Protected Card Holders / Wallets</b>	379-382		

# GLOSSARY

Except wherever mentioned as customised, the page numbers refer to Ready Stocks

PAGE NO

G-S

PAGE NO

<a href="#">Glass Bottles</a>	210-211	<a href="#">Men's Wallets</a>	134, 391-393, 399-400, 402, 404-405, 410-411, 415, 418-422
<a href="#">Golf Accessories, Shirts, Caps</a>	243-260	<a href="#">Miscellaneous Items</a>	439-440, 445
<a href="#">GRS / RCS Certified Materials Used</a>	<a href="#">12-32, 39-40, 45, 49, 57</a>	<a href="#">MOBILE, IT, MULTIMEDIA GADGETS/ACCESSORIES</a>	116-124
<b>HANS LARSEN</b>		<b>MOLESKINE</b>	
Caps	303, 306	Backpacks and Bags	155-158
Drinkware including Mugs	201-202, 208-211, 213, 216, 219-220,	Customisation	308
Drinkware including Mugs	224-225, 228-231, 235	Leather	418-423
Sustainable Collection	34, 36	Moneyclips	421
<b>HAPPINESS THEME ARTICLES</b>	432	Notebooks, Pens, Diaries	309-314, 337-338
<a href="#">Headphones, Earphones, Earbuds</a>	82-83, 114-116	Smart Writing Sets	112, 315
<b>HOODIES AND WINTERWEAR</b>	301-302	<a href="#">Mousepads</a>	370, 373
<b>IMPACT COLLECTION- SUSTAINABLE</b>	<a href="#">07, 12, 17-18, 21-27</a>	<a href="#">Mugs, Tumblers, Flask</a>	191-192, 212-224
<b>ISLAMIC GIFTS</b>	183, 441	<b>NOTEBOOKS</b>	307-326
<a href="#">Keyholders</a>	376-378	<a href="#">OCEAN BOTTLES- Sustainable</a>	<a href="#">28-32</a>
<a href="#">Lady Gifts</a>	423-429	<a href="#">OFFICE BAGS, MESSENGER BAGS, LAPTOPS BAGS</a>	158, 165-166, 169-173, 396
<b>LAMBORGHINI</b>		<a href="#">OTTO HUTT PENS (PRECIOUS METALS)</a>	339-340
CD Holders / Cases	370, 439	<b>PENS</b>	330-356
Leather & Travel	137, 415	<a href="#">PIERRE CARDIN</a>	
Shirts and Polos	296	Calculators and Foot Scales	372
Silver & Watches	370, 426	Crystal Clocks	372
<a href="#">Lanyards and Accessories</a>	375	Luggage Tags- Silver Plated	131
<a href="#">Laptop Bags, Messenger Bags, Office Bags</a>	158, 165-166, 169-173, 396	Notebooks and Pens, Notepads	330-331, 333-336
<a href="#">Laser Pointers</a>	122	Playing Cards Gift Set	440
<b>LEATHER ARTICLES (GENUINE LEATHER)</b>		Portfolio Notebooks with Inbuilt Powerbanks	109-110
Bags- Toiletry, Waist Bags	135, 408	Portfolios and Folders	332
Card Holders	379-380, 383-385, 400, 405-406, 412,	Silver Plated Desk Pieces	370-371
Card Holders	415-417	Wine Accessory	440
Folders, Organisers, Notebooks	414	<a href="#">Pitchfix Golf Accessories</a>	244-253
Gift Sets	397-398, 401, 403-404, 407	<a href="#">Plastic Pens</a>	350-354
Golf Gloves & Pouches	243, 259	<a href="#">Playing Cards</a>	440
Ladies Articles	402, 415, 423-425	<a href="#">Polo Shirts</a>	267-296
Men's Articles incl Mobile Phone Case	393, 399-400, 402, 404-405, 410-411,	<a href="#">Powerbanks &amp; Chargers- Multifunctional</a>	94-104
Men's Articles incl Mobile Phone Case	415-422	<a href="#">Powerbanks Inbuilt in Folders / Travel Wallets</a>	107-110
Travel Wallets	402, 406-407, 413, 416	<a href="#">PPE / Covid-fight Range</a>	59-82
<a href="#">Lens- 3D &amp; Universal for Smartphones</a>	123-124	<a href="#">Promo Gadgets</a>	115-126
<b>LIGHT UP LOGO ON ARTICLES</b>		<a href="#">Protein Shakers</a>	235
Keyrings and Pens	353, 377	<a href="#">RFID Protection Accessories</a>	133-134, 171, 379-386
Mugs	219	<b>SAMSONITE</b>	
Powerbanks including Wireless	96-98, 101	BACKPACK	143
Safety Night Sensor	121	MASK POUCH	68
Speakers	103-104	<a href="#">SANITIZERS from Dabur Dermoviva</a>	67
USB Hubs	118	<a href="#">SANTHOME PROTECT- ANTI COVID</a>	65-66, 70, 77-78, 80-81
Wireless Chargers, Charging Cables	91, 117		
<a href="#">Luggage Weight Scale</a>	130		
<a href="#">Luggage Bag Tags</a>	131		
<a href="#">Lunch Box / Bags</a>	174, 225, 228		
<b>MASKS &amp; SUPPORT ACCESSORIES</b>	63-66, 70		



# GLOSSARY

Except wherever mentioned as customised, the page numbers refer to Ready Stocks

PAGE NO

S-Z

PAGE NO

<b>SANTHOME</b>		<b>Water Bottles</b>	189-190, 193-211
Backpacks and Bags	136, 140-141, 159-162, 164-165, 171-173	<b>Webcam Covers</b>	124
Caps	303, 305	<b>Wellness &amp; Outdoors, Fitness &amp; Sports</b>	235-260
<b>CHANGE Collection &amp; Sustainable</b>	<b>7-11, 13-16, 19-20, 46, 48</b>	<b>Wine Accessory</b>	440
Drinkware	189-193, 233-234	<b>WIRELESS CHARGERS &amp; WIRELESS POWERBANKS</b>	80, 85-97, 100, 106, 107, 109
Leather Gifts	383-385, 397-403, 415-416, 424-425	<b>Wrist Bands</b>	439
Notebooks and Folders	86, 106, 317-320, 322, 328-329, 359-360	<b>XDESIGN / XDXCLUSIVE / XDCOLLECTION</b>	
Polo Shirts and Tshirts	267-293, 299-300	Audio, Headphones, Earphones, Earbuds, TWS	83, 114, 116
RFID (Safety) Products	383-384	Bags & Backpacks, Bobby Bags	139, 142, 144-152, 166
Tech incl Powerbank inbuilt Folders	106, 130	<b>Caps - IMPACT COLLECTION</b>	<b>304</b>
Trolley Bags & Travel Accessories	136-138	Charging Cables	117
<b>Selfie Sticks (with built-in Powerbanks)</b>	120	Drinkware	203-207, 215-220
<b>Shirts- Dress Shirts</b>	296-297	IT Mobile Multimedia, VR	123
<b>SKROSS Travel Adapters</b>	127-128	Magnifier	373
<b>Solar Chargers &amp; Solar Bags</b>	102, 150	Masks	63-64
<b>Speakers</b>	102-104	Pens	104, 343-344
<b>Stress Relievers</b>	374	Powerbanks, Powerbank Folders, Wireless Chargers	92, 101, 107
<b>Stylus Pens</b>	342-347, 353-356	RFID Protection Accessories	133-134, 171
<b>Sunglasses &amp; Safety Goggles</b>	52, 66	<b>Solar Chargers &amp; Solar Bags</b>	<b>102, 150</b>
<b>Sunshades for Cars</b>	437	Stationeries, Notebooks, Folders, Organisers	111, 307, 321, 324, 358, 360
<b>SUSTAINABLE GIFTS</b>	<b>7-32, 39-40, 45-46, 57</b>	<b>Sustainable (IMPACT) Collection</b>	<b>07, 12, 17-18, 21-27</b>
<b>Sweaters &amp; Winterwear</b>	301-302	Tools & Torches	37, 438
<b>SWISS HIGHLANDER Gift Sets</b>	388-389	Travel	133-135
<b>SWISS PEAK</b>		USB Hub & USB Flash Memory drives	104-106, 118
Notebooks, Pens, Stationeries	329, 341-342, 360	<b>Yoga Mats</b>	236
Outdoors, Travel, Drinkware	131, 214, 438		
<b>T- Shirts Round Neck</b>	298-301		
<b>TACX Biobottles &amp; Fruit Infuser Bottles</b>	199, 208		
<b>Tools &amp; Torches</b>	437-439		
<b>Travel Accessories / Gadgets / Goods</b>	127-140, 393, 413, 416		
<b>Travel Wallets / Pouches</b>	130-136, 393, 413, 416		
<b>Trolley Bags</b>	137-138		
<b>TUMI Luxury Articles</b>	391-396		
<b>TWS Earbuds</b>	82-83		
<b>UMA PENS from Germany</b>	348-351		
<b>USB Flash Memory Sticks / Drives</b>	104-106		
<b>USB Hubs</b>	118		
<b>UV-C STERILISATION ARTICLES &amp; GADGETS</b>	77-82		
<b>VIROBLOCK POLO SHIRTS / HEIQ SWISSTECH</b>	72		
<b>Virtual Reality Glasses</b>	123		
<b>Watches</b>	84-85, 426		

# Sustainability and Transparency Organization and Certification



Textile Exchange is a global non-profit that works closely with members to drive industry transformation in preferred fibers, integrity and standards, and responsible supply networks.



The Global Recycled Standard (GRS) is an international, voluntary, full product standard that sets requirements for third-party certification of recycled content, chain of custody, social and environmental practices, and chemical restrictions.



The Recycled Claim Standard (RCS) is an international, voluntary standard that sets requirements for third party certification of recycled input and chain of custody. The goal of the RCS is to increase the use of recycled materials.

## THE IMPACT

### Recycling 1 Plastic Bottle\*

= CO2 reduction 25.2 g  
= fuel-savings 0.52 g  
= saving water 88.6 mL

### 1000 kgs Recycled PET

= 67,000 pcs bottles  
= CO2 reduction 4.2 tons  
= fuel-savings 36.4 kgs  
= saving water 6,200 L

\* Calculations based on 600 ml plastic bottle

## COMPLIANCE AND PRODUCT SAFETY

We ensure safe, long-lasting and aesthetic products from certified compliant supply chain.

## COPYRIGHT

Legal action will be taken against unauthorised infringements and / or reproduction of any content from this catalog without prior written permission.

## INTELLECTUAL PROPERTIES

All brand names and trademarks are properties of respective owners and used as examples only. Santhome, Hans Larsen, eco-neutral, @memorii, Giftology and dryncool are registered trademarks of Santhome Holdings Limited (BVI). Any infringement and duplication attempt will be dealt with legally.

## E&OE

Mistakes, color deviations, size variations, packaging discrepancy, etc.

the creative  
Stitch

## CONNECT WITH US

---

**EMAIL:** [SUDI KSHA@THECREATIVESTITCH.COM](mailto:SUDI KSHA@THECREATIVESTITCH.COM)

**PHONE:** +971 50 700 4475

**WEB:** [WWW.THECREATIVESTITCH.COM](http://WWW.THECREATIVESTITCH.COM)